

CORPORATE DOCUMENTATION

2.2 1 2
2.2 3 4
2.2 5 6
2.6 13 14
2.7 21 22

2.3 1 2
2.3 3 4
2.3 5 6
2.5 13 14
2.7 21 22

2.4 1 2
2.4 3 4
2.4 5 6
2.8 13 14
2.5 21 22

IGE+XAO
GROUP

Shaping the Future
of the Electrical PLM,
CAD and Simulation

N
PE

"If the presence of electricity

can be made visible

in any part of the circuit,

We



Samuel

Morse

I see no reason why intelligence

may not be transmitted

instantaneously by electricity." (1832)





The IGE+XAO Group

Historically, the Group began by developing, selling and maintaining CAD (Computer Aided Design) software dedicated to the electrical industry. Electrical CAD software applications are used to design and maintain the electrical side of manufacturing processes and end products. Today, CAD is the main business of the Group and represents 70% of its revenue.

From the late 90's, the IGE+XAO Group has started the development of a software suite covering the overall requirements of the electrical harnesses design market. This new market has led the Group to start building, as early as 2005, a complete and dedicated PLM (Product Lifecycle Management) software range. These solutions have attracted numerous global players in aerospace and transportation such as Airbus, Embraer or Alstom.

Since mid-2014, with the purchase of Prosyst, IGE+XAO offers a complete software range for electrical functional simulation.



	31 locations in 20 countries		More than 93.000 licences sold
	33 years of experience		370 employees
	Listed on NYSE Euronext since March 1997		

Headquarters

Colomiers, France

Subsidiaries

Belgium
Brazil
Bulgaria
Canada
China
Denmark
France
Germany
Greece
India
Italy
Morocco
Netherlands
Poland
Spain
Switzerland
Tunisia
Turkey
UK
USA

R&D

Bulgaria
Denmark
France
Morocco
Poland
Tunisia

Support

Bulgaria
Brazil
Canada
China
France
Morocco
Poland

Partners

Albania
Armenia
Austria
Australia
Azerbaijan
Belarus
Bosnia and
Herzegovina
China
Colombia
Croatia
Czech Republic
Hungary
Indonesia
Kazakhstan
Kosovo
Kyrgyzstan
Macedonia
Malaysia
Moldova
Montenegro
New Zealand
Uzbekistan
Portugal
Romania
Russia
Serbia
Singapore
Slovakia
Slovenia
Tajikistan
Thailand





**A strong
international
presence**

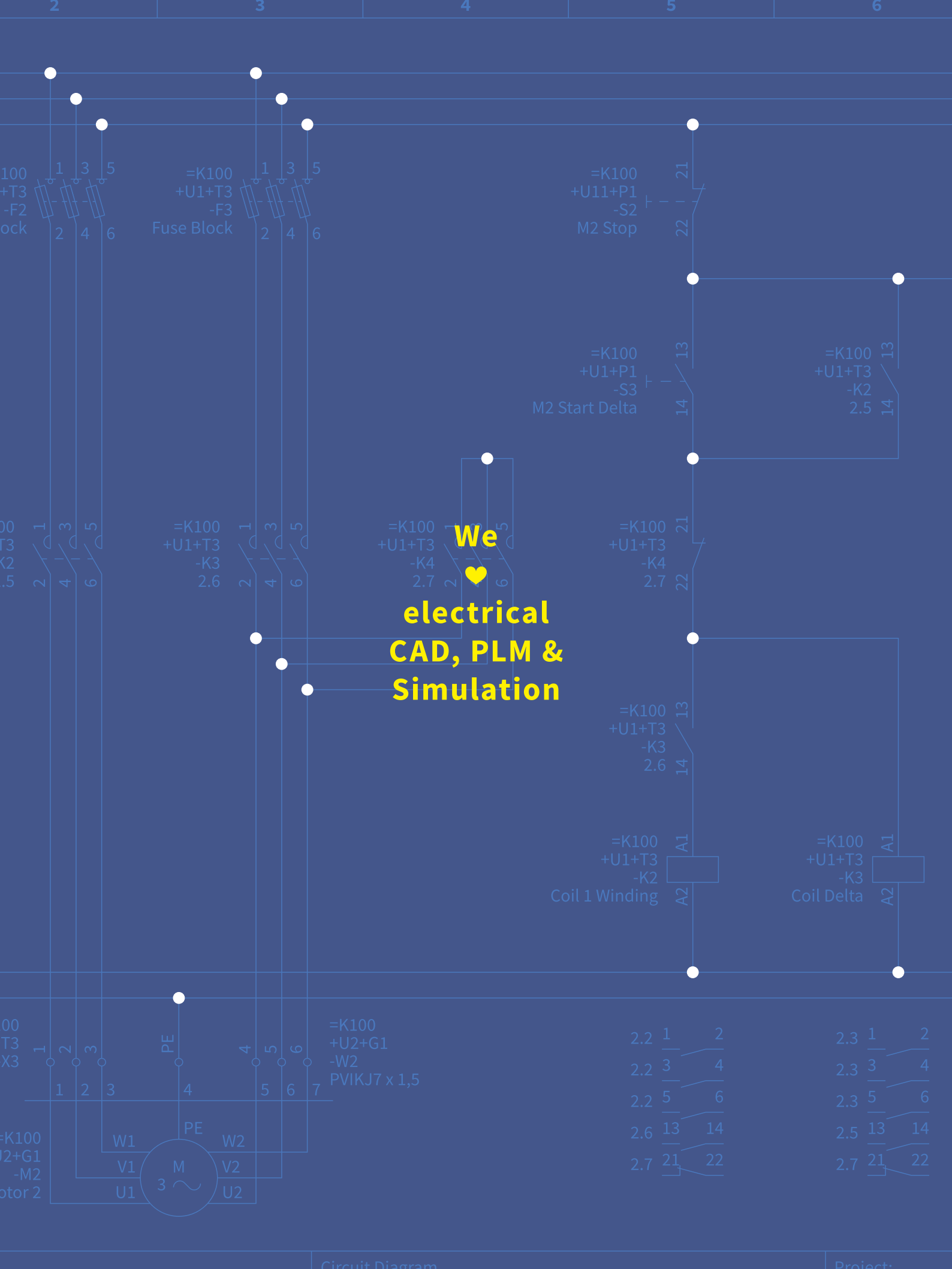

We ❤️
electrical
CAD, PLM &
Simulation

An important customer base

Our 43,000 customers worldwide belong to a wide range of industries including:

- ▶ Automotive
- ▶ Transportation
- ▶ Power generation
- ▶ Electrical and electronic equipment
- ▶ Food, chemical and steel industries
- ▶ Building and public works
- ▶ Engineering
- ▶ Machine building
- ▶ Automation
- ▶ etc.

Number of licences sold

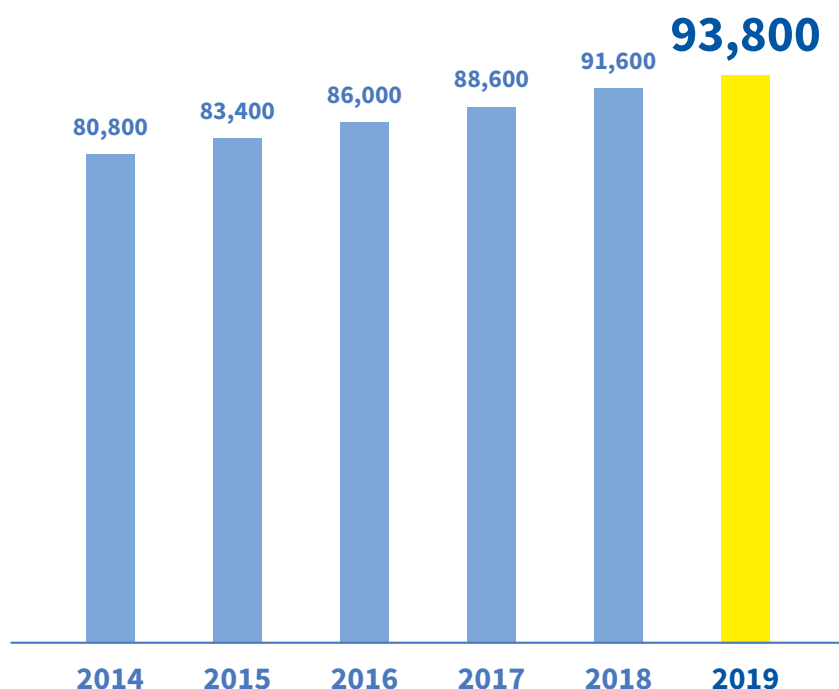

A strong presence in 8 industries

8 strategic markets

In each identified market, IGE+XAO covers the requirements with a complete range of modular products.



Aerospace



Automotive



Railway



Shipbuilding



Equipment & Machinery



Automation & Plant



Power generation & Energy



Construction

6 business domains



System design



Data management



Electrical design

(the core business of IGE+XAO)



Communication



Electrical manufacturing



Simulation and diagnostic

Solutions for all company sizes

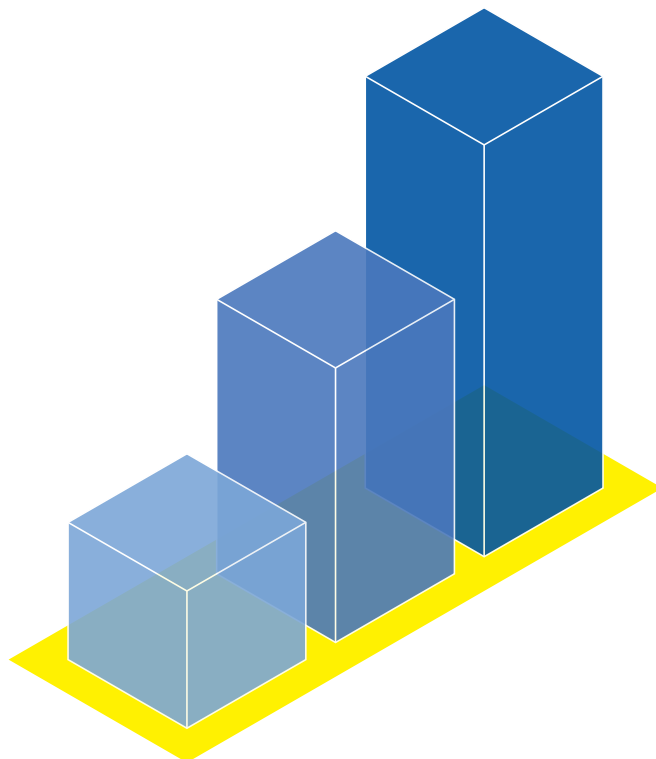

- Key Accounts
- Small and Medium Businesses
- Very Small Businesses

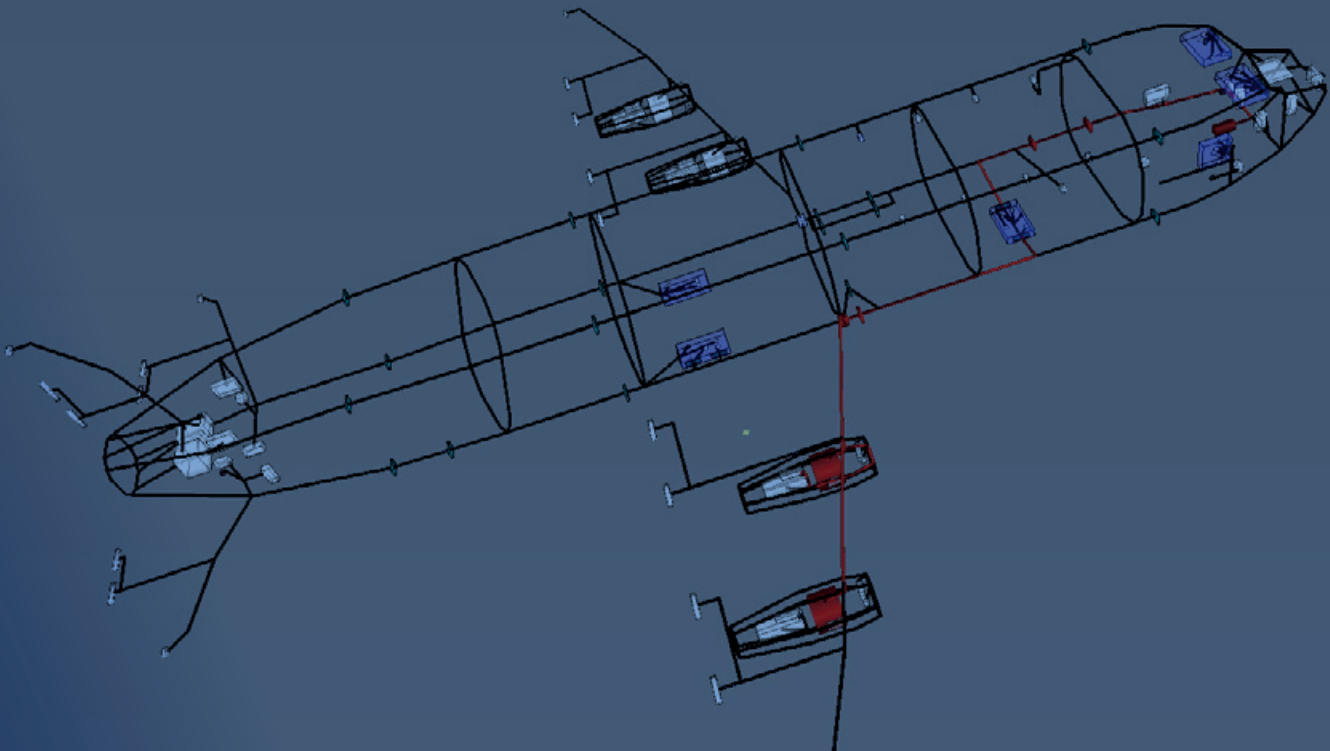

Aerospace

Market requirements

- More electrical aircraft
- Increasing numbers of components
- Numerous configurations to support
- More and more complex cabling
- Heterogeneous software tools
- Production time reduction

IGE+XAO answers

- **Powerful PLM (Product Lifecycle Management) suite**
- **Complete solution from design to manufacturing**
- **High level of integration**
- **Scalable solutions (from stand alone to PLM)**
- **Configuration management**

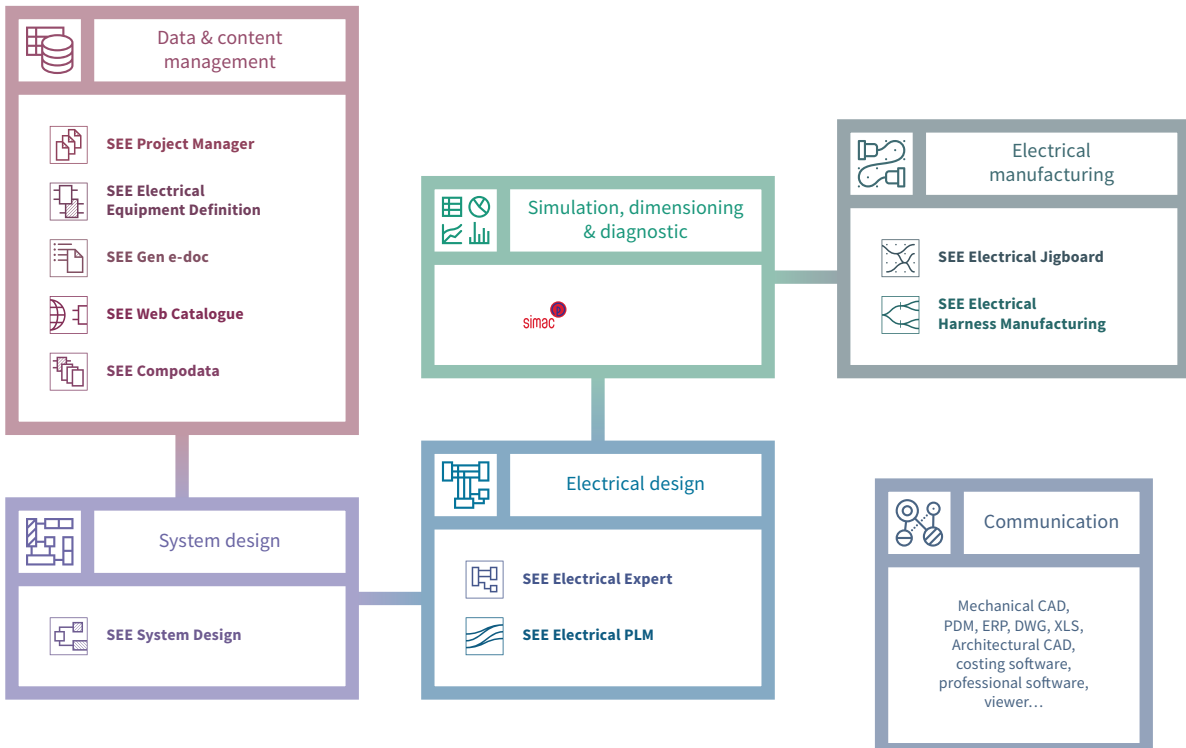

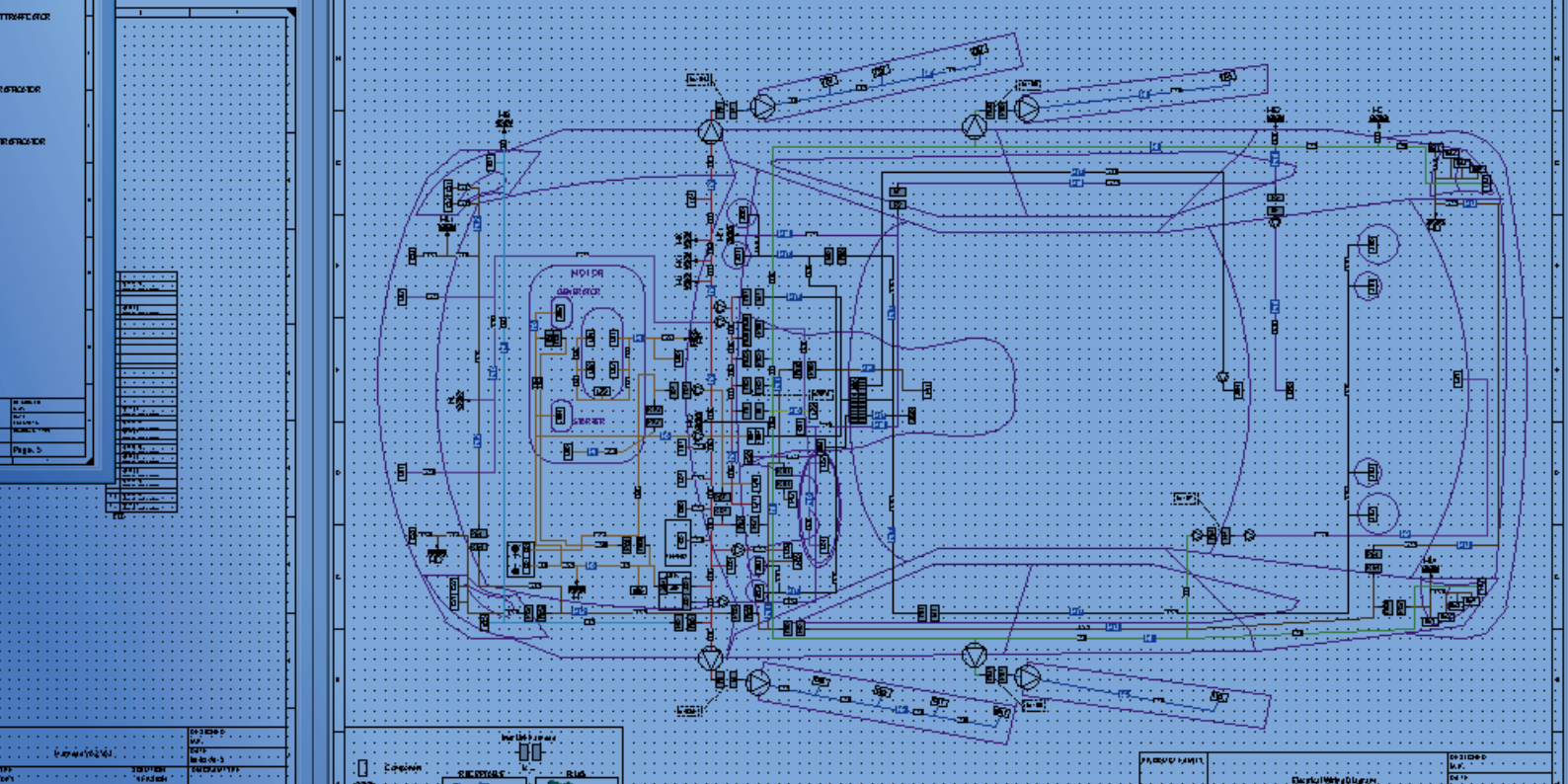

Automotive

Market requirements

- Hybrid vehicle technologies
- Shorter development time
- Options management
- Increasingly complex electronic content

IGE+XAO answers

- **Powerful PLM (Product Lifecycle Management) suite**
- **Automotive specific functions**
- **High level of integration**
- **Configuration management (options and variants)**

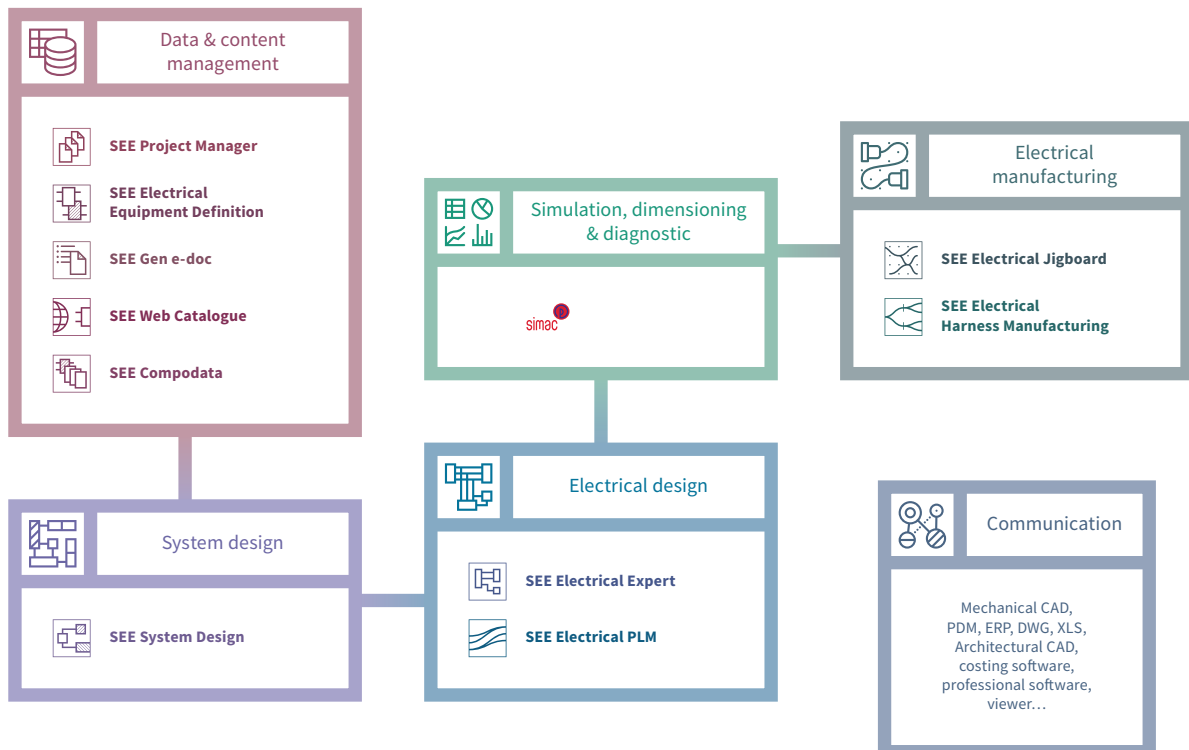

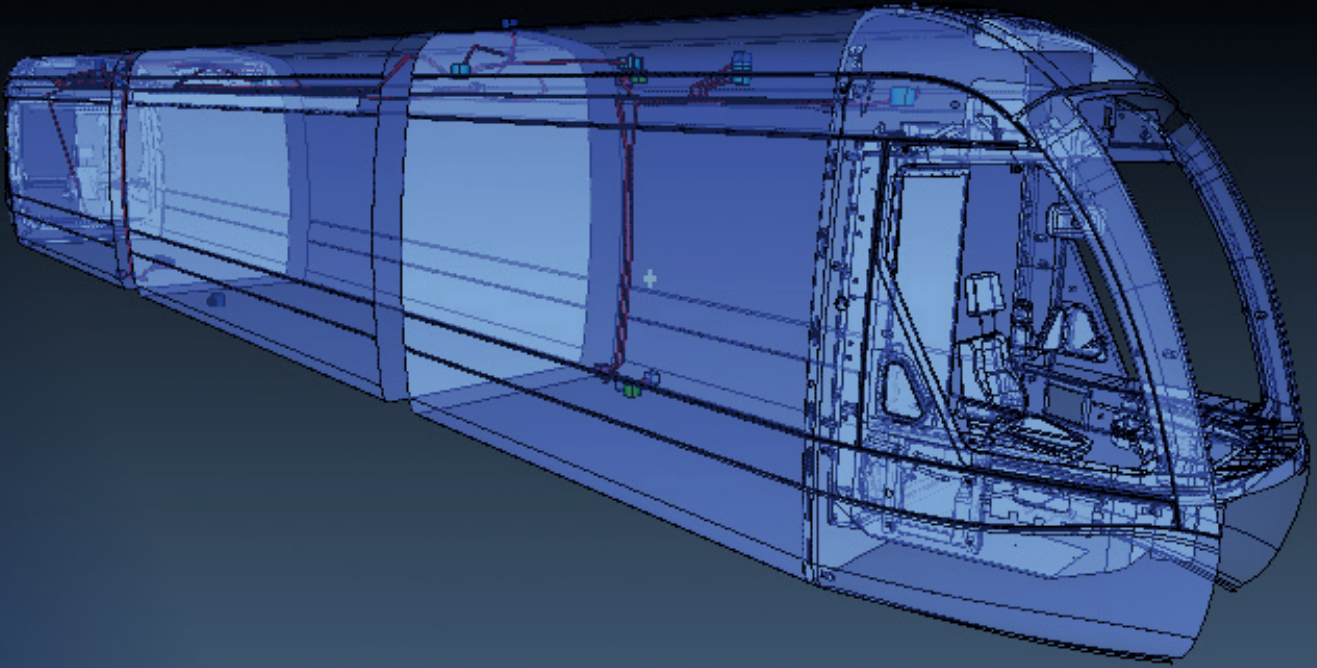

Railway

Market requirements

- "Intelligent train"
- Equipment reliability
- Safety
- Eco efficiency
- Additional comfort and services

IGE+XAO answers

- **Powerful PLM (Product Lifecycle Management) suite**
- **Railway specific functions**
- **High level of integration**
- **Traceability**
- **Configuration management**

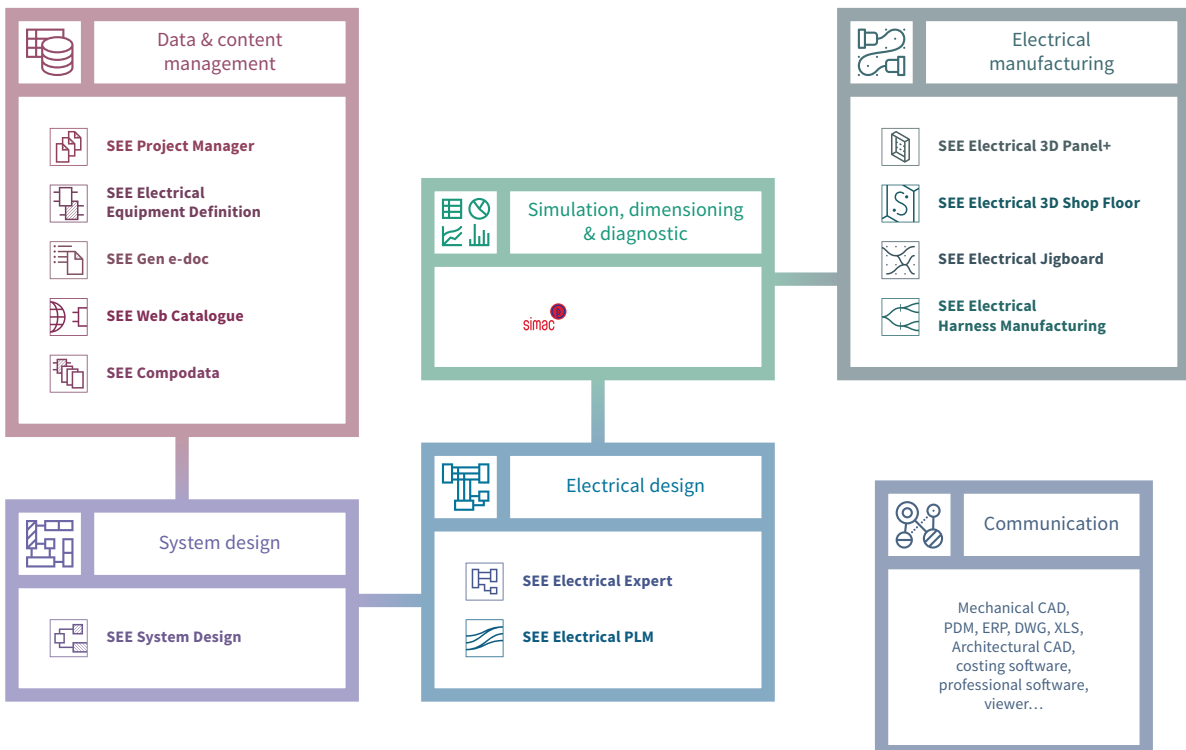

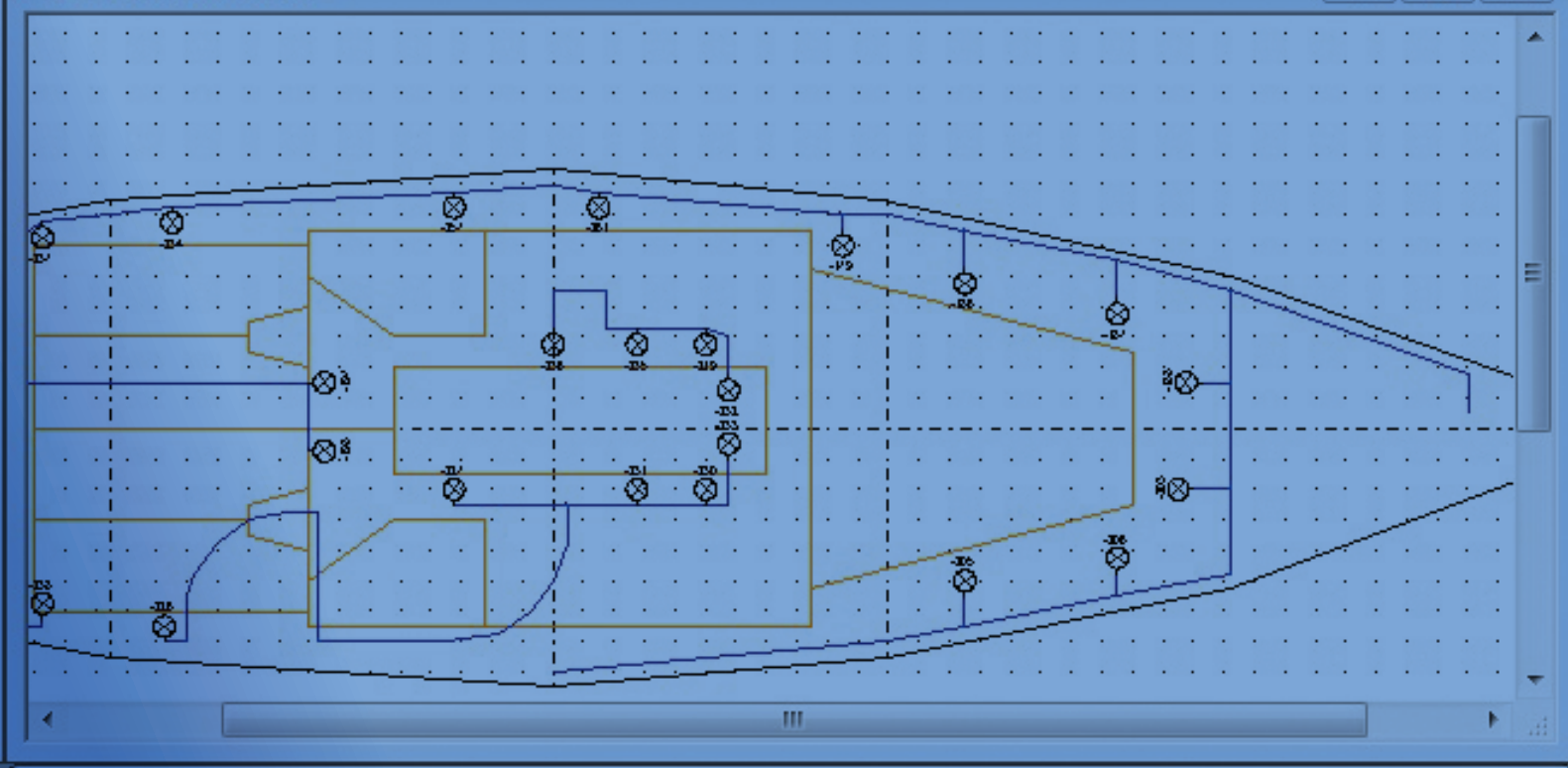

Shipbuilding

Market requirements

- "Smart" ship
- Increasing number of equipment
- Operational condition guarantee
- Ship lifelong evolutions
- Cost optimization

IGE+XAO answers

- Complete Visio-based offer that goes from functional design to schematics and cabling generation
- Communication capabilities (PLM and CAD integration)
- Collaborative design
- Multi function (hydraulics, pneumatics, electrical...)
- Configuration management (options and variants, versioning/maturity)

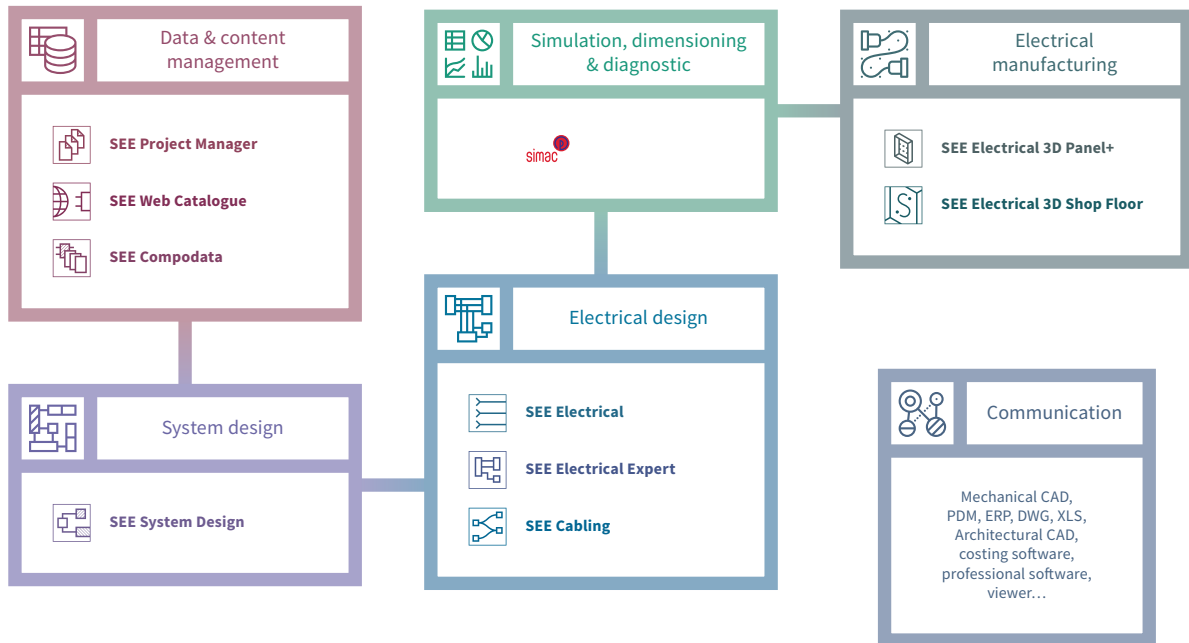

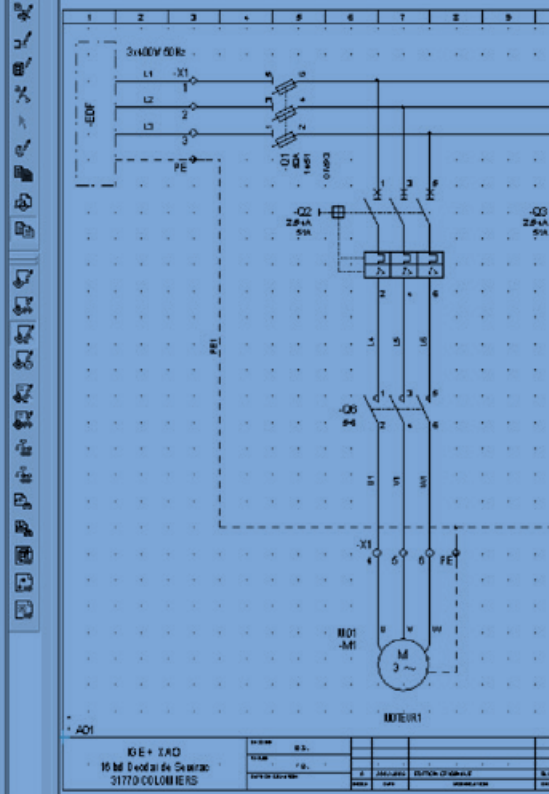
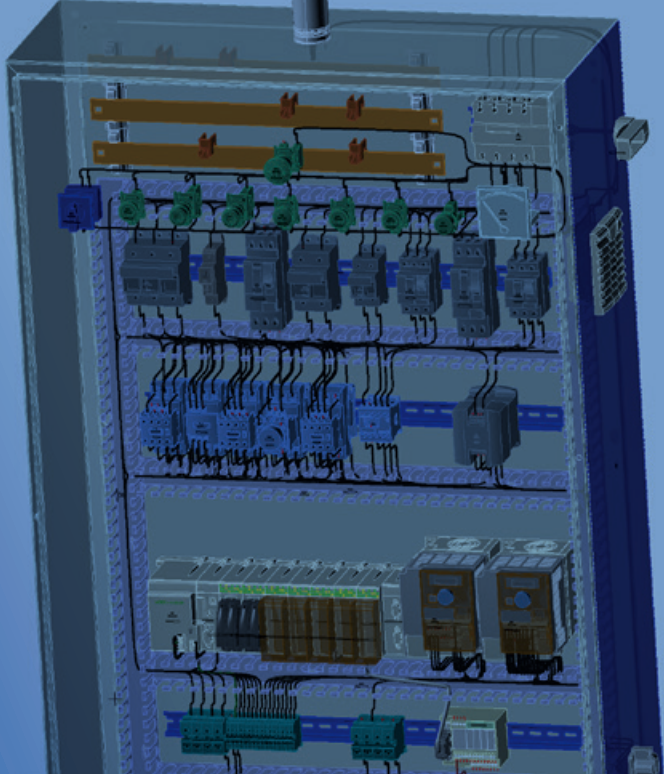

Equipment & Machinery

Market requirements

- More and more complex equipment
- Customization
- Reliability

IGE+XAO answers

- Solutions for all company sizes
- One of the most complete product ranges on the market
- Communication capabilities
- Customizable and scalable solutions
- Expertise from large customer base
- Strong partnership with key electrical equipment players
- Wire harnesses expertise
- Automatic schematic generation

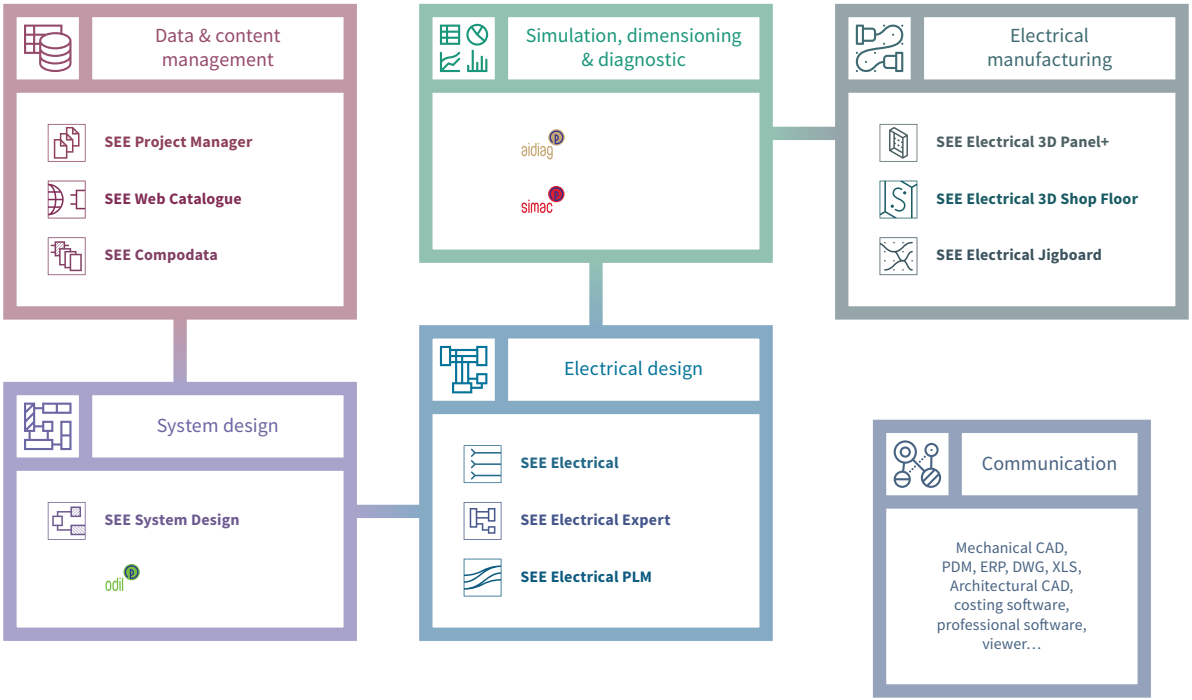

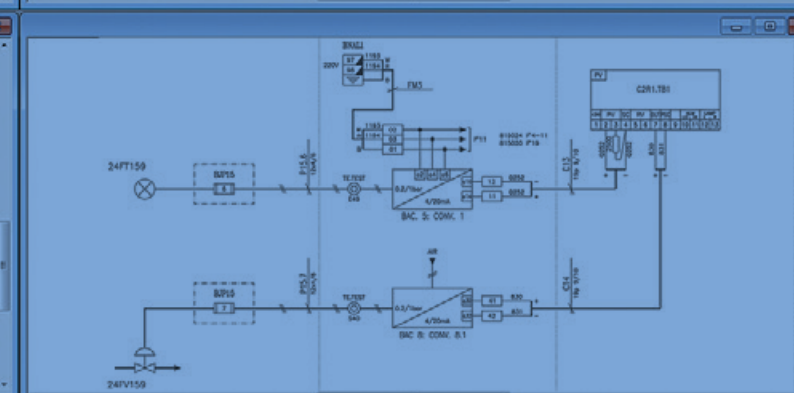
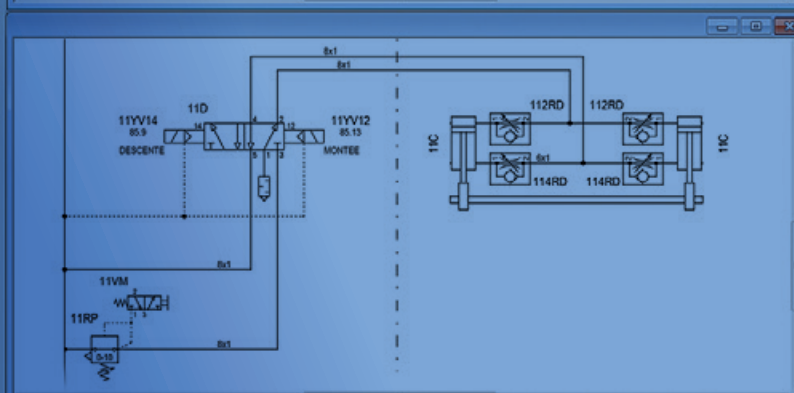
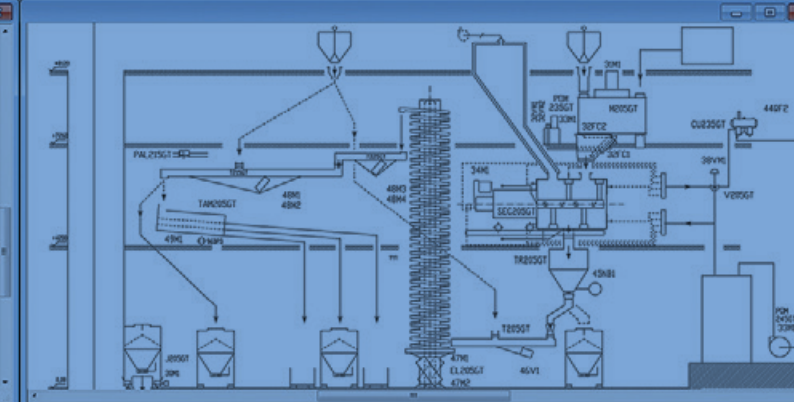
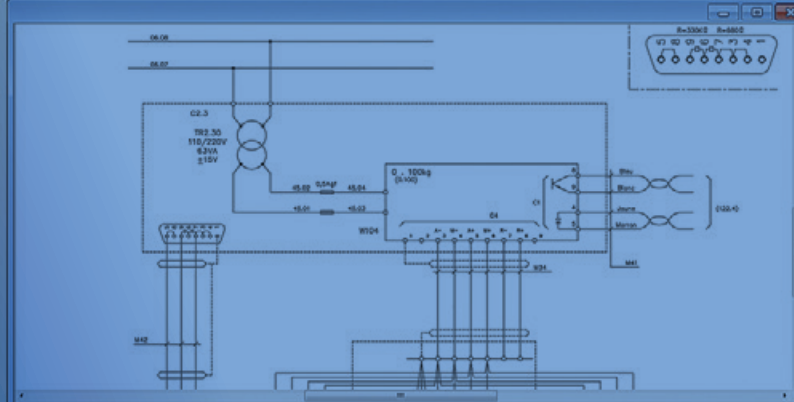

Automation & Plant

Market requirements

- Lifetime cost optimization
- Reliability
- Predictive maintenance
- Flexibility

IGE+XAO answers

- Solutions for all company sizes
- One of the most complete offer on the market
- Communication capabilities
- Best-in-class features
- Complete environment (CEI, IEC, symbols...)
- Customizable and scalable solutions
- "Easy to use" software
- Expertise from large customer base
- Quality verification functions

Data & content management

- SEE Project Manager
- SEE Web Catalogue
- SEE Compdata

Simulation, dimensioning & diagnostic

aidiag
simac

Electrical manufacturing

- SEE Electrical 3D Panel+
- SEE Electrical 3D Shop Floor

System design

- SEE System Design

odii

Electrical design

- SEE Electrical
- SEE Electrical Expert
- SEE Electrical PLM

Communication

Mechanical CAD, PDM, ERP, DWG, XLS, Architectural CAD, costing software, professional software, viewer...

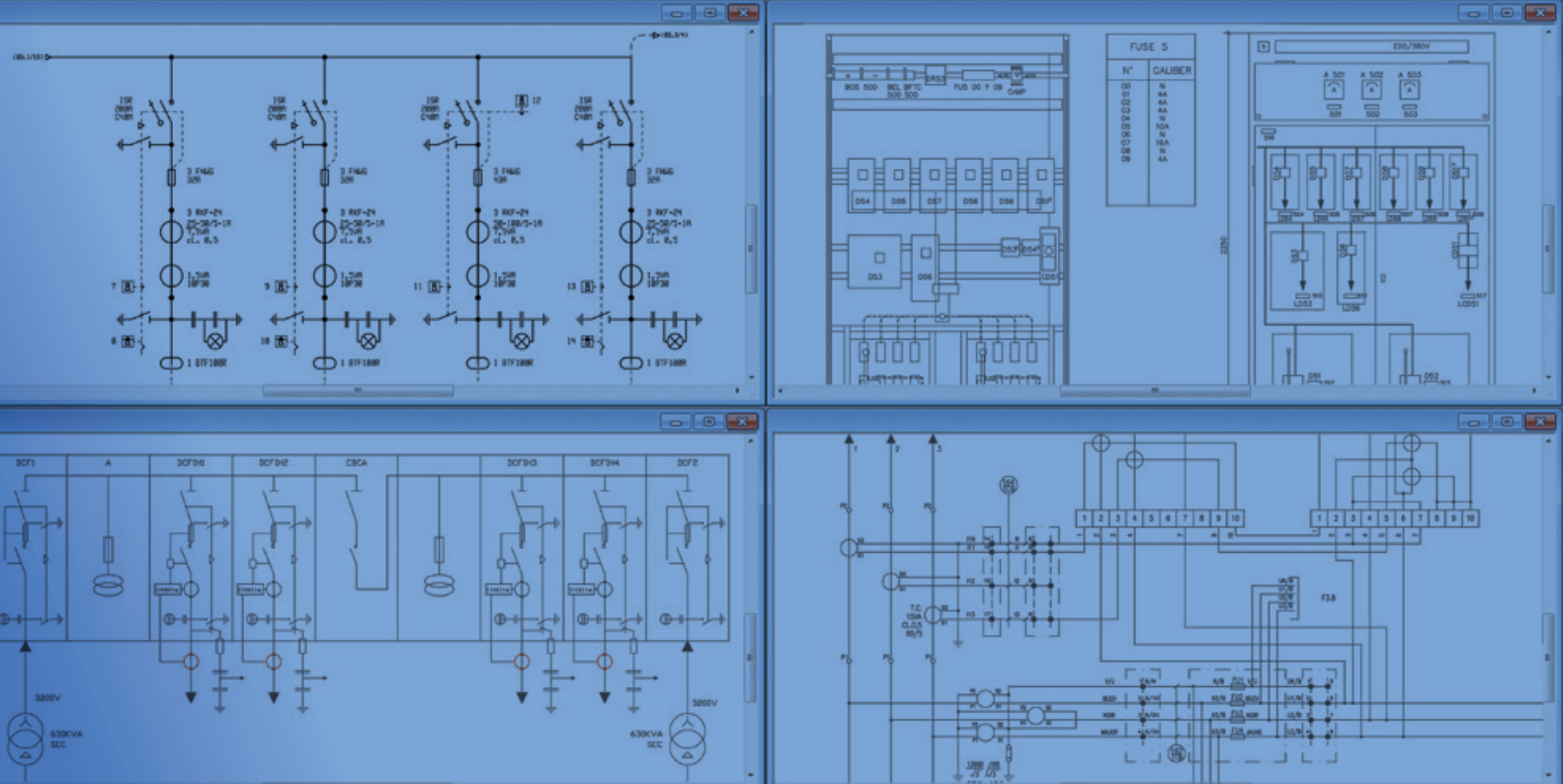

Power Generation & Energy

Market requirements

- Safety
- Alternative & sustainable energies
- Smart supply and demand
- Smart grid
- 24/7 operations
- Environmental regulations

IGE+XAO answers

- Complete offer from a powerful Visio-based offer to “on-the-shelf” easy to use packages
- Communication capabilities
- Collaborative solution
- Customizable and scalable solutions

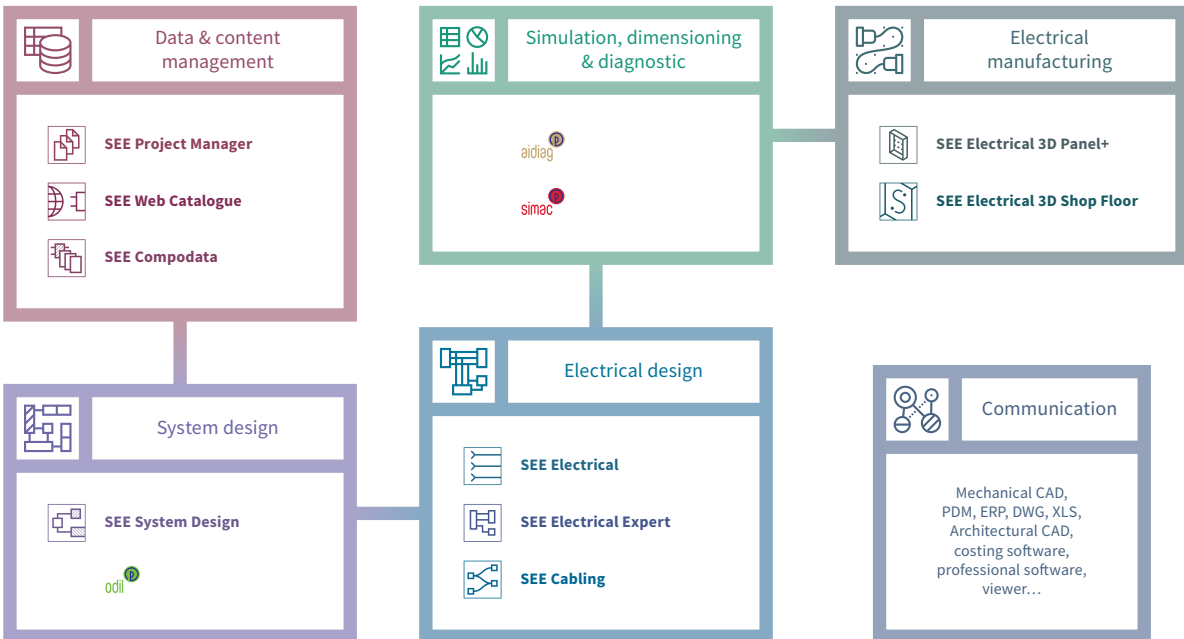

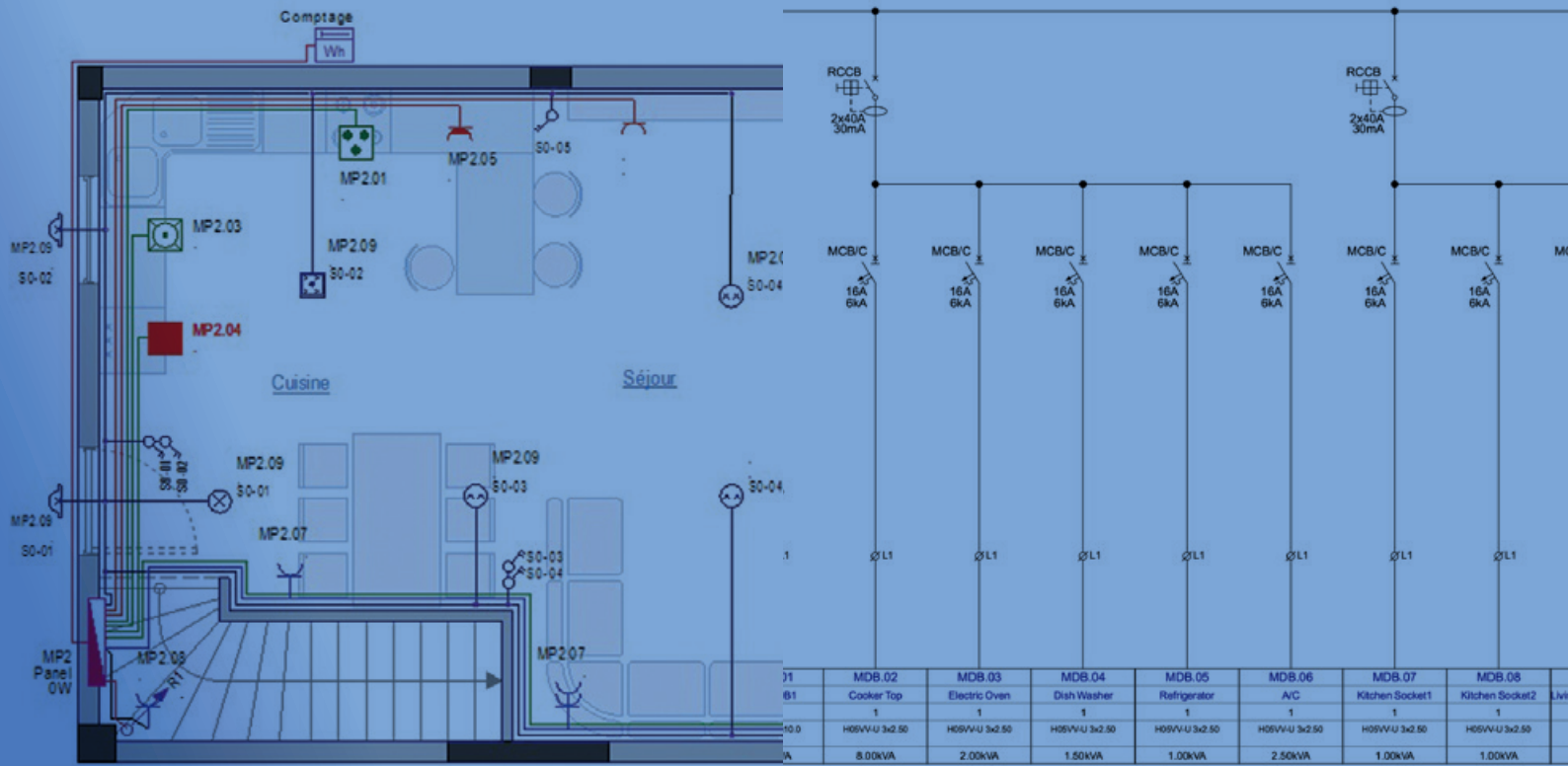

Construction

Market requirements

- Smart buildings
- Increasing number of equipment (datacom)
- Importance of standards/regulations

IGE+XAO answers

- Automatic schematic generation
- "All in one" product
- Easy-to-use calculation package
- Communication capabilities

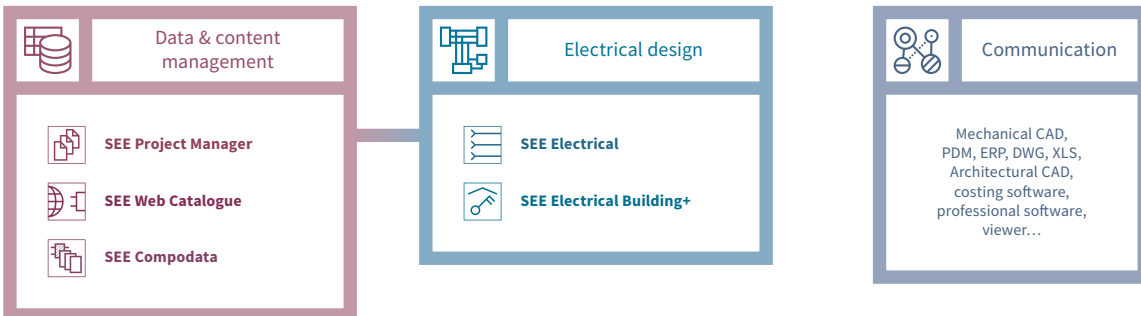

An organization built around our clients

In response to the market fast-moving needs, the IGE+XAO Group has put in place an “extended enterprise” organization.

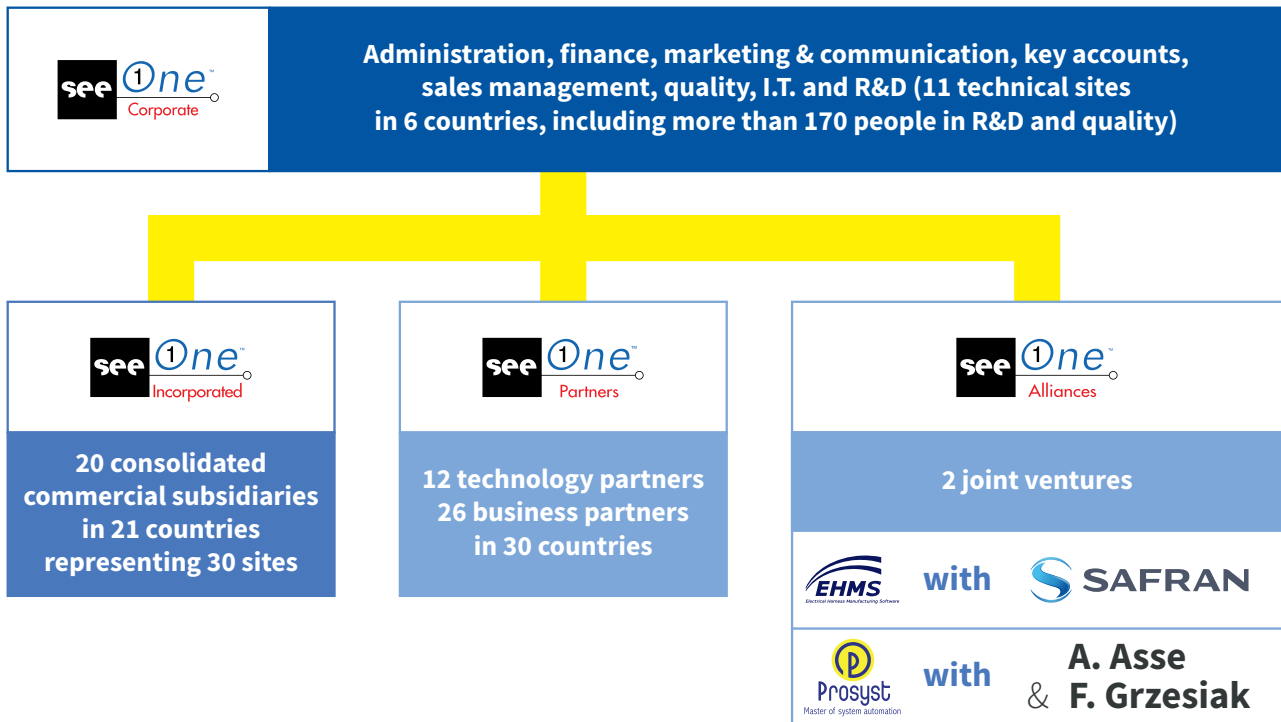

Value-added services

Training sessions adapted to clients' needs and worldwide telephone helpline.

Over 70 experts are available to our clients for in more than 12 languages throughout the world.

Dedicated team to customize the software to our clients' needs.

The "Assistance+" team supports our clients in implementing and integrating IGE+XAO solutions. Our R&D team also provides specific developments as well as integration services.

Value-added consulting.

Prosynt also provides consulting services around electrical simulation and diagnostic.

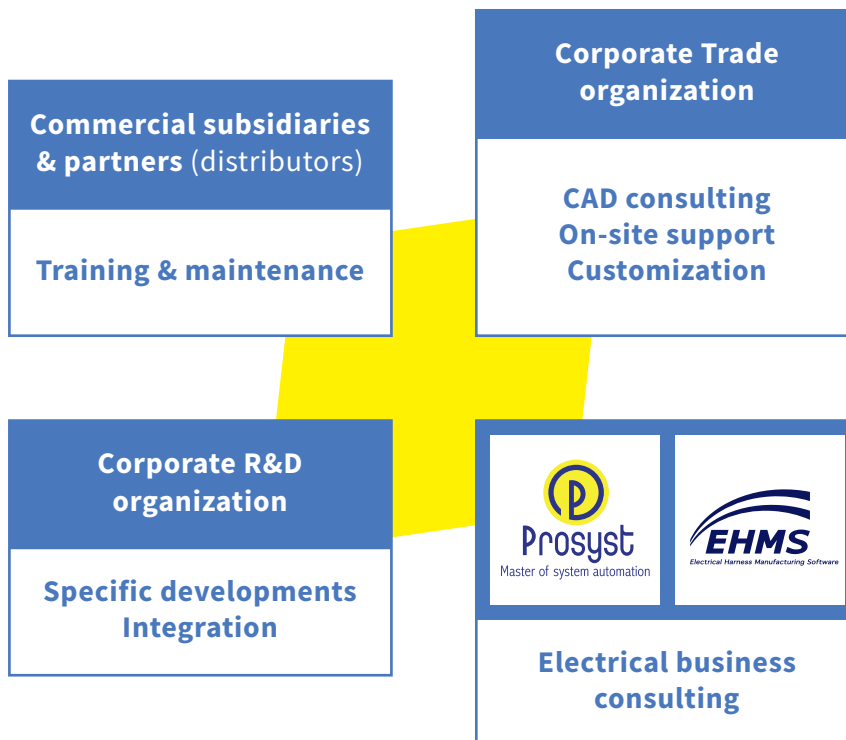

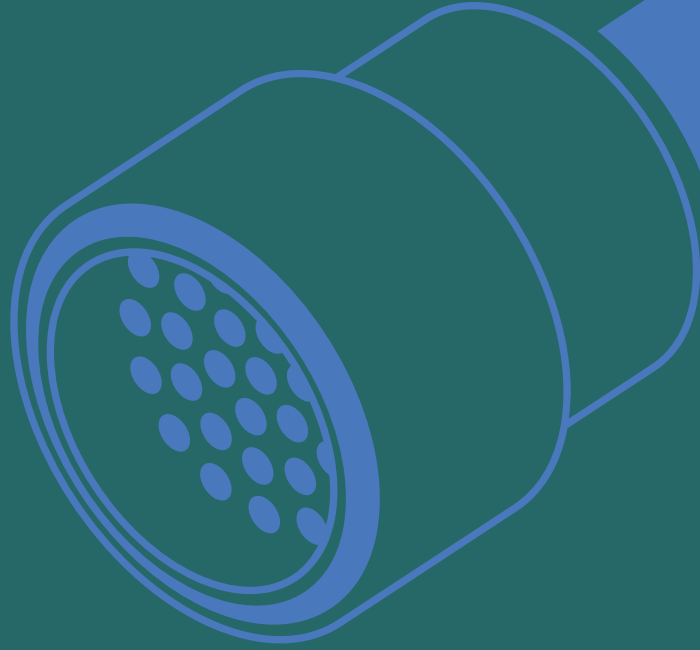

We
♥
harness
design



Research & Development

Innovation

140 people focused on Electrical CAD and PLM, Design, test and quality

R&D activity 2019

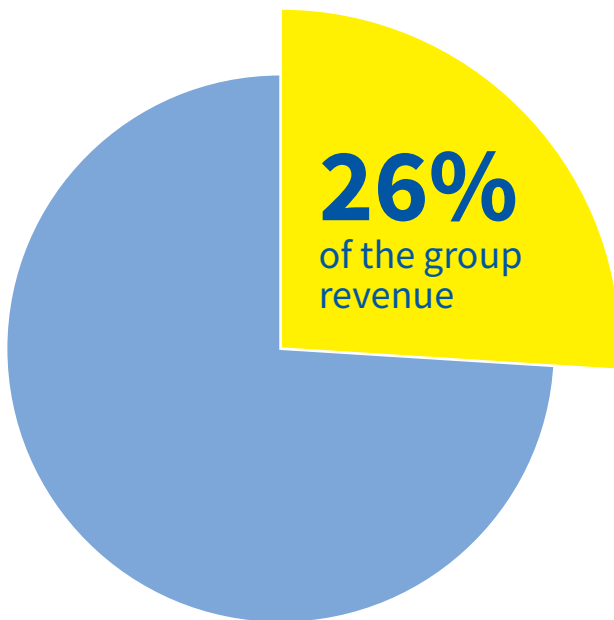

R&D program

Business

- Automatic generation of schematics
- Automatic cabling
- System engineering
- Harness manufacturing
- Dimensioning
- Simulation
- Content management
- etc.

Technology

- Concurrent engineering
- Product lifecycle management (PLM)
- Product data management (PDM)
- Cloud applications
- 3D
- etc.

Human Resources

Strong values

Strong and shared values are key to the Group success.

- **Customer first**
- **Dare to disrupt**
- **Embrace different**
- **Learn everyday**
- **Act as owners**



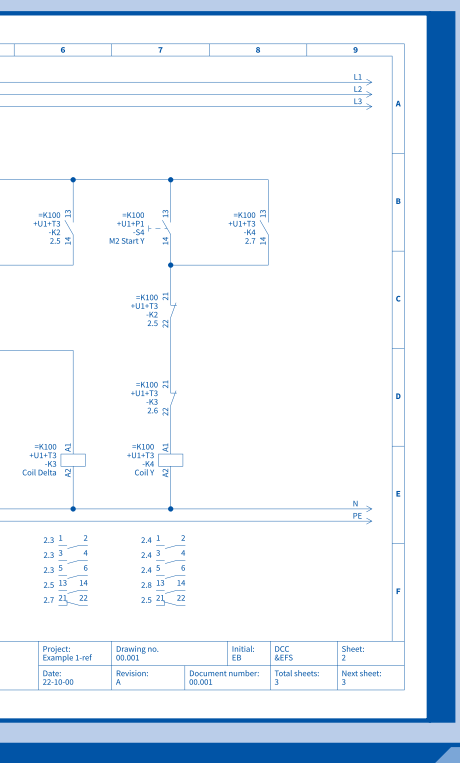

We
♥
coding &
coffee

IGE+XAO
GROUP

Locations

IGE+XAO Headquarters – France

16, boulevard Déodat de Séverac
CS 90 312
31 770 **Colomiers** CEDEX
T. +33 (0)5 62 74 36 36

IGE+XAO Belgium

Terhulpesteenweg 181 bus 21
1170 **Brussel**
T. +32 (0)2 219 09 59

IGE+XAO Brazil

Praça Doutor Monteiro, 97
Sala 02, Centro
CEP 12020-250
Taubaté, São Paulo
T. +33 05 62 74 36 36

IGE+XAO Bulgaria

205 Al. Stamboliyski Blvd.
1309 **Sofia**
T. +359 2 8101 145

IGE+XAO Canada

7777, Boul. Louis-H. Lafontaine
suite 201 – **Montréal** (Anjou)
Québec H1K 4E4
T. 1-514-353-3445

IGE+XAO China

Room 21N1
Huatai Securities Building
No.90 East ZhongShan Road
Nanjing 210002
T. +86 (0)25 8689 0716

IGE+XAO France

8, rue François Delage
94 230 **Cachan**
T. +33 (0)1 55 48 17 77
3, rue de Lorraine
44240 **La Chapelle-sur-Erdre**
T. +33 (0)2 51 89 72 12

Centre Étoile Valentine
20 Traverse de la Montre
CS 30 035
13 396 **Marseille** CEDEX 11
T. +33 (0)4 91 44 89 06

106, rue de la Liberté
38 180 **Seyssins**
T. +33 (0)4 76 70 16 42

30 rue des frères Dana
59 300 **Valenciennes**
T. +33 (0)3 27 30 59 59

Synergie Park
Bâtiment Syn Wit
1^{er} étage
1 rue Louis Néel
59 260 **Lezennes**
T. +33 (0)3 27 30 59 59

IGE+XAO Germany

Marie-Bernays-Ring 19a
D-41199 **Mönchengladbach**
T. +49 (0)2166 13 39 10

Im Wöhr 2
D-76437 **Rastatt**
T. +49 (0)7222 77 47 40

IGE+XAO Greece

3 Promitheos str
GR-54627 **Thessaloniki**
T. +30 23 10 24 49 11

IGE+XAO India

#1/1, Gover Road
Cox town
Bangalore 560005
T. +91 9535235447

IGE+XAO Italia

Via delle Canovine, 46
I-24126 **Bergamo**
T. +39 035 45 96 167

IGE+XAO Morocco

24, rue Ali Abderrazak
Quartier Racine Extension
1er étage
20100 **Casablanca**
T. +212 5 22 23 05 55

IGE+XAO Netherlands

Beersdalweg 84 A
6412 PE **Heerlen**
T. +31 (0)45 561 16 36

IGE+XAO Nordic

T. +45 45 94 21 00

Bistrupvej 22
3460 **Birkerød**
Denmark

Ellemosen 4
8680 **Ry**
Denmark

IGE+XAO Poland

Pl. Na Stawach 3
30-107 **Kraków**
T. +48 12 630 30 30

ul. Strusińska 2
33-100 **Tarnów**
ul. Doktora Józefa Putka 9
34-100 **Wadowice**

IGE+XAO Spain

C/ Resina, 29 C
1^a planta
28021 **Madrid**
T. +34 91 797 90 71

IGE+XAO Switzerland

Rue de Flore 5
CH-2502 **Biel/Bienn**
T. +41 (0) 32-365 93 93

IGE+XAO Tunisia

Pôle technologique El Ghazela
Bloc I3, 3^{ème} étage A01
Rte de Raoued km 3,5
2088 **Ariana**
T. +216 70 83 45 45

IGE+XAO Turkey

Küçükbakkalköy Mah.
Vedat Günyol Cad.
Flora Residence No:1
Kat:28 D. No:2803
34750 Ataşehir / **İstanbul**
T. +90 (0) 216 988 1600

IGE+XAO UK

7, Riverside Court
Station Road
Croft
Leicestershire LE9 3EL
T. +44 (0) 1455 817455

IGE+XAO USA

2540 King Arthur Blvd.
Suite 209-M
Lewisville, TX 75056
T. +1 (972) 410-3610