

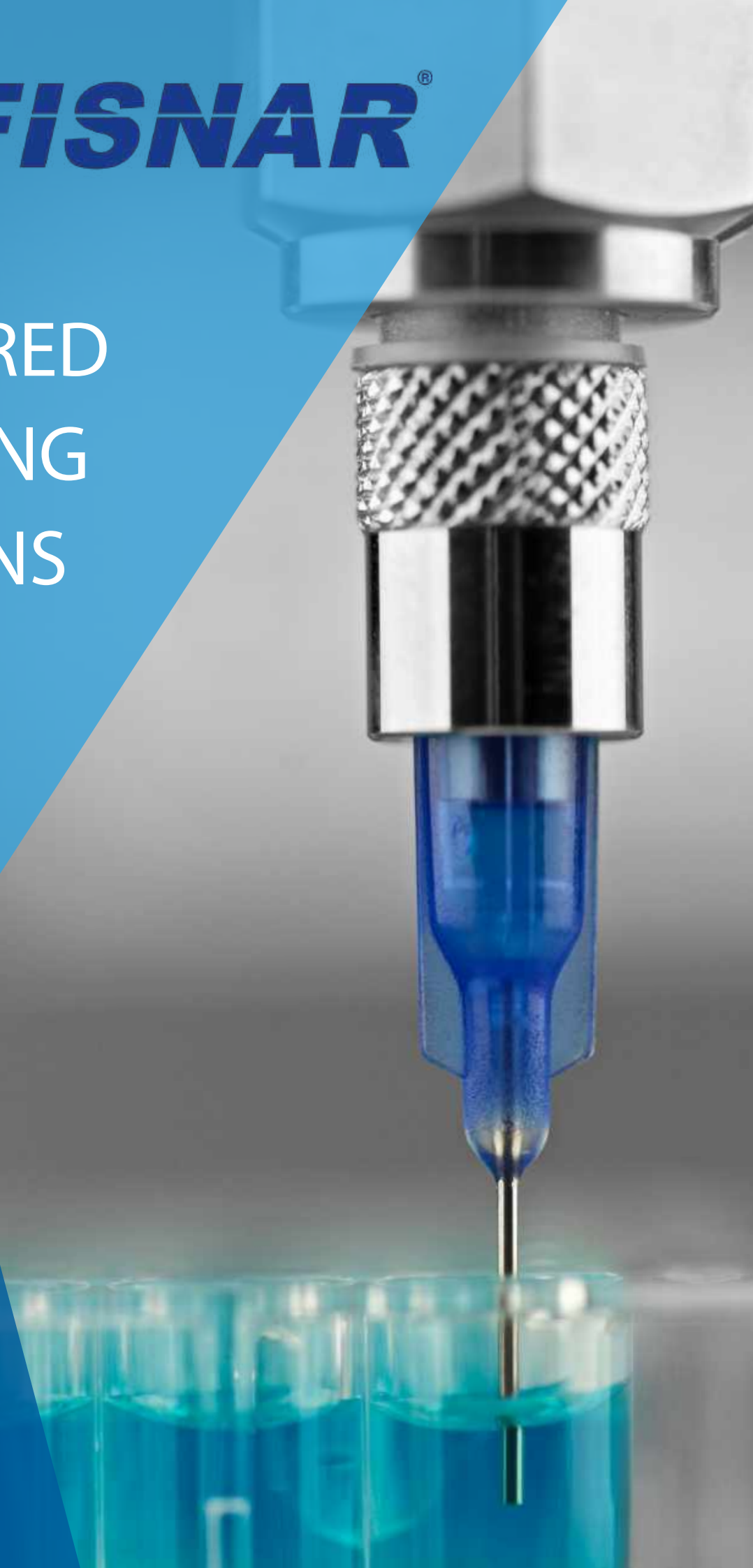

ENGINEERED DISPENSING SOLUTIONS





Contents

Dispensing Consumables



Syringe Barrels, Pistons, Tip & End Caps	2, 3	Dispensing Tips & Nozzles	10-20
Barrel Adapters & Syringe Barrel Kits	4, 5	Brush Tips & Dispense Bottles	21-23
Manual Syringes, Plungers & Syringe Barrel Dispensers	6	Cartridges & Accessories	24-26
DCK Dispensing Selection Kit	7, 8	Cartridge Dispensers & Barrel Loaders	27-33
Squeeze Bottles & Caps	9		

Liquid Dispensers



Digital Dispensers	37-39	Foot Pedal Dispenser	48
Switch Assemblies	40	Vacuum Pick Up Systems	49
Peristaltic Pump Dispenser	41, 42	Pinch Tube Pens	50
Handheld Dispensers	43-46	Gravity Fed Bottle	50
Dual Cartridge Dispenser	47		

Dispensing Valves



Valve Selection Guide	53	Mini Spool	65
Valve & Controller Compatibility Chart	54	High Pressure	66
Pinch Tube	55, 56	Positive Displacement	67
Diaphragm	57	Auger	68
Needle	59	Progressive Cavity Valve & Accessories	69-75
Cartridge	60	Jet Valve & Accessories	77-80
Spray	61, 62	Benchtop Stands	81, 82
Poppet	63, 64	Valve Controllers	85-90

Reservoirs & Pumps



IJ Series	93, 94	Plastic & Metal Fittings	104-106
FT Series	95	Specialty Fittings & Gauges	107
Clear View Pressure Chambers	97, 98	Air/Fluid Manifolds & Mufflers	108
Extruder Systems	99, 100	Filter Regulators & Hose/Tubing	109, 110
Pump Systems	101, 102		

Robotics



Rotary Table	113	Robot Holder Assemblies	137-144
Benchtop	114-124	Robot Bracket Spare Parts Guides	145, 146
Gantry	125-130	Valve Bracket Holder & Stand Compatibility Chart	147
Vision Systems & Accessories	131-134	Cartridge Retainer/Syringe Bracket Holder & Stand Compatibility Chart	148
Robot Accessories Compatibility Chart	135	Robot Kits	149-153

Dispensing Consumables

Premium Dispense Management



QuantX™ is a fluid management system defined by its carefully designed and precisely engineered components.

Together these components provide a superior industrial dispensing experience, resulting in reduced waste, greater accuracy, and improved yields.

QuantX™ Syringe Barrels

QuantX™ syringe barrels feature a highly accurate manufacturing process that combines minimal resistance and parallel uniformity over the length of the syringe barrel.

Manufactured from premium grade silicone-free polypropylene, these syringe barrels are available in clear for non-UV materials, amber for UV protection up to 550nm, and opaque black for maximum light protection.

All barrels are designed with a round base to fit QuantX™ barrel adapter assemblies.



Size	Clear	Amber	Black	I.D. (inch)	I.D. (mm)	O.D. (inch)	O.D. (mm)	Length (inch)	Length (mm)
3 cc	8001001	8001040	8001045	0.379	9.62	0.453	11.5	2.941	74.7
5 cc	8001002	8001041	8001046	0.500	12.72	0.567	14.6	2.756	70.0
10 cc	8001003	8001042	8001047	0.622	15.78	0.733	18.6	3.567	90.6
30 cc	8001004	8001043	8001048	0.891	22.62	1.000	25.4	4.634	117.7
55 cc	8001005	8001044	8001049	0.889	22.57	1.020	25.9	6.898	175.2

QuantX™ Syringe Barrels & Piston Sets





Syringe barrel and piston sets ensure that matched QuantX™ components are always used in the QuantX™ fluid management system providing optimum dispensing performance.

Size	Clear	Amber	Black
3 cc	8001058	8001063	8001068
5 cc	8001059	8001064	8001069
10 cc	8001060	8001065	8001070
30 cc	8001061	8001066	8001071
55 cc	8001062	8001067	8001072



QuantX™ Pistons

Evenpress™ Piston Selection

-  Smooth flow green pistons prevent air entrapment and material waste by wiping the syringe barrel wall clean.
-  Flat wall blue pistons are recommended for reducing potential stringing and bouncing when dispensing high-viscosity fluids.
-  Low viscosity orange pistons are used to prevent dripping of watery fluids and accidental back-flow into the dispenser.
-  Soft black rubber pistons are used to prevent tunneling in high-viscosity fluid materials.

Size	Smooth Flow Green	Flat Wall Blue	Low Viscosity Orange	Unlubricated Black	Lubricated Black
3 cc	8001006	8001010	8001506	8001510	8001514
5 cc	8001007	8001011	8001507	8001511	8001515
10 cc	8001008	8001012	8001508	8001512	8001516
30/55 cc	8001009	8001013	8001509	8001513	8001517

QuantX™ Syringe Barrel Tip Caps

Tip caps provide an air-tight seal allowing storage of pre-filled syringe barrels.

Item Number	Type
8001038	Flat
8001039	Pointed



QuantX™ Syringe Barrel End Caps

End caps feature a push and twist design to ensure an air tight seal and secure the neck opening of the syringe barrel when in storage.



Size	Item Number
3 cc	8001034
5 cc	8001035
10 cc	8001036
30/55 cc	8001037

QuantX™ Syringe Barrel Adapter Assemblies

QuantX™ syringe barrel adapter assemblies are provided with a convenient push-to-connect fitting to connect to the controller from the syringe barrel. Fitted with Buna Nitrile O-rings.

They are available in two hose lengths and optional micron filter-trap to prevent entry of fluids and fumes into the controller.

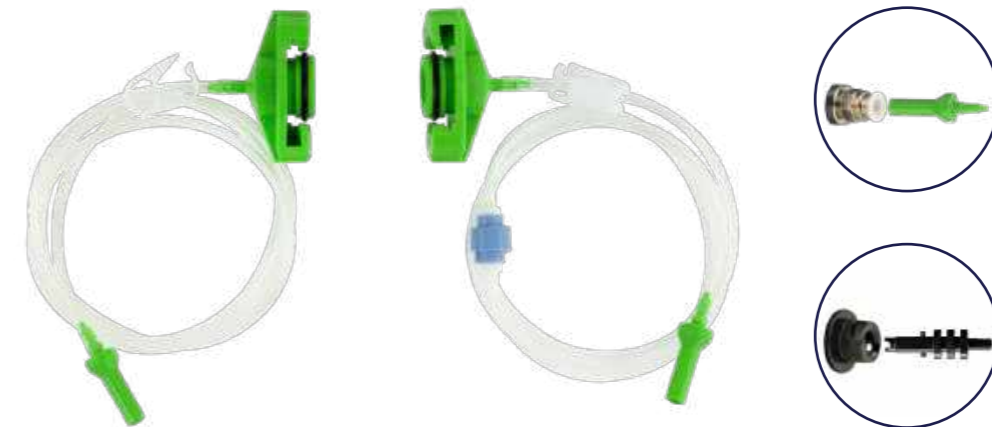

Green push-to-connect fitting comes assembled on all barrel adapter assemblies. For use with Fisnar DC50, DC100, and DC200 controllers.

Black bayonet fitting also included for connection to quick-connect style controllers.

Size	3 ft (0.9 m)	6 ft (1.8 m)	3 ft with Filter (0.9 m)
3 cc	8001014	8001018	8001050
5 cc	8001015	8001019	8001051
10 cc	8001016	8001020	8001052
30/55 cc	8001017	8001021	8001053

QuantX™ Adapter Head with O-Ring

Size	Item Number
3 cc	8001026
5 cc	8001027
10 cc	8001028
30/55 cc	8001029



QuantX™ Adapter Head Replacement O-Rings

Size	Buna N	Viton®	EPDM
3 cc	8001030	8001054	8001518
5 cc	8001031	8001055	8001519
10 cc	8001032	8001056	8001520
30/55 cc	8001033	8001057	8001521



QuantX™ Syringe Barrel Kits

Syringe barrel kits are available for validation of different size and color variations for both UV and non-UV materials.

The QK-CSK pictured includes all syringe barrels, adapter assemblies, and the most popular pistons and dispense tips.

Size	Clear	UV
3/5/10 cc	QK-3510	QK-3510UV
30/55 cc	QK-3055	QK-3055UV
Complete Kit	QK-CSK	



QK-3510



QK-3510UV



QK-3055



QK-3055UV



QK-CSK

Manual Syringes

Disposable, graduated, polypropylene, luer-lock style, non-sterile syringes. Fitted with a silicone lubricated rubber piston and plunger for manually dispensing a variety of fluids.

Size	Manual Syringe
3 cc	8401006
5 cc	8401007
10 cc	8401008
35 cc	8401009
60 cc	8401012



QuantX™ Manual Syringe Plungers

An ergonomic, lightweight, reusable hand plunger for manually dispensing a variety of fluids.

Compatible for use with all QuantX™ syringe barrels, green smooth-flow, and black rubber pistons.

Size	Manual Plunger
3 cc	8401014
5 cc	8401015
10 cc	8401016
30 cc	8401018



JD927 Manual Syringe Barrel Dispensers

Lightweight and comfortable dispensers with an easy twist-on barrel mounted design. Each squeeze of the trigger advances the plunger by 0.24" (6 mm) dispensing a precise amount of material every time.

These dispensers are capable of dispensing most fluids by using a finger-tip control and push button plunger release.

Size	Item Number
10 cc	JD927-10
30/55 cc	JD927-3055



QuantX™ Dispensing Selection Kit

The DCK800 selection kit includes a variety of dispense tips, syringe barrels, pistons, and caps. A supply reference chart is also included.



Item Number	Description
DCK800	Dispensing Selection Kit

Color	Gauge	Item Number	Description	Quantity
Green	18	8001158	45 Degree	2 ea
Blue	22	8001161	45 Degree	2 ea
Clear	27	8001164	45 Degree	2 ea
Green	18	8001168	90 Degree	2 ea
Blue	22	8001171	90 Degree	2 ea
Clear	27	8001174	90 Degree	2 ea
Black	16	8001259	UV Safe Tapered	2 ea
Black	18	8001261	UV Safe Tapered	2 ea
Black	20	8001262	UV Safe Tapered	2 ea
Amber	15	5701309	Soft Brush Tip	1 ea
Amber	15	5701310	Hard Brush Tip	1 ea
Natural	-	5601427	Pointed Tip Cap	3 ea
Green	-	8001039	Pointed Tip Cap	3 ea
Green	-	8001038	Flat Tip Cap	3 ea
Clear	-	8001001	3 cc Round Barrel	1 ea
Clear	-	8001002	5 cc Round Barrel	1 ea
Clear	-	8001003	10 cc Round Barrel	1 ea
Green	-	8001034	3 cc End Cap	1 ea
Green	-	8001035	5 cc End Cap	1 ea
Green	-	8001036	10 cc End Cap	1 ea
Green	-	8001006	3 cc Piston	1 ea
Green	-	8001007	5 cc Piston	1 ea
Green	-	8001008	10 cc Piston	1 ea

Color	Gauge	Item Number	Description	Quantity
Olive	14	8001269	Single Tapered	5 ea
Gray	16	8001270	Single Tapered	5 ea
Green	18	8001271	Single Tapered	5 ea
Pink	20	8001272	Single Tapered	5 ea
Blue	22	8001273	Single Tapered	5 ea
Red	25	8001274	Single Tapered	5 ea
Green	18	8001075	1/4" Blunt End	2 ea
Blue	22	8001078	1/4" Blunt End	2 ea
Clear	27	8001081	1/4" Blunt End	2 ea
Olive	14	8001084	1/2" Blunt End	5 ea
Amber	15	8001085	1/2" Blunt End	5 ea
Black	16	8001086	1/2" Blunt End	5 ea
Green	18	8001087	1/2" Blunt End	5 ea
Pink	20	8001088	1/2" Blunt End	5 ea
Purple	21	8001089	1/2" Blunt End	5 ea
Blue	22	8001090	1/2" Blunt End	5 ea
Orange	23	8001091	1/2" Blunt End	5 ea
Red	25	8001092	1/2" Blunt End	5 ea
Clear	27	8001093	1/2" Blunt End	5 ea
Lavender	30	8001094	1/2" Blunt End	5 ea
Green	18	8001097	1" Blunt End	2 ea
Blue	22	8001100	1" Blunt End	2 ea
Clear	27	8001103	1" Blunt End	2 ea
Green	18	8001107	1 1/2" Blunt End	1 ea
Blue	22	8001110	1 1/2" Blunt End	1 ea
Clear	27	8001113	1 1/2" Blunt End	1 ea
Gray	-	8001254	1" PTFE-Lined Tip	2 ea
Pink	-	8001255	1" PTFE-Lined Tip	2 ea
Green	18	8001287	1/2" Flexible	2 ea
Blue	22	8001289	1/2" Flexible	2 ea
Red	25	8001290	1/2" Flexible	2 ea
Green	18	8001293	1 1/2" Flexible	1 ea
Blue	22	8001295	1 1/2" Flexible	1 ea
Red	25	8001296	1 1/2" Flexible	1 ea

DISPENSING CONSUMABLES

DISPENSING CONSUMABLES

Manual Dispensing Bottles



A selection of low-density squeeze bottles for manually dispensing a variety of fluids available in both oval and round bottle types. Caps and bottles are interchangeable based on application requirements. Caps come in different thread sizes and correspond to matching threads on bottles. *Bottles and caps sold separately.*



Size	Thread	Oval Bottle	Luer Lock Cap	Slip Lock Cap
1/2 oz	15 mm	EAOB0515	EALLC15	EASC15
3/4 oz	15 mm	EAOB07515	EALLC15	EASC15
2 oz	18 mm	EAOB218	EALLC18	EASC18
4 oz	20 mm	EAOB420	EALLC20	EASC20
8 oz	24 mm	EAOB824	EALLC24	EASC24



Size	Thread	Round Bottle	Luer Lock Cap	Slip Lock Cap
1/2 oz	15 mm	EARB0515	EALLC15	EASC15
1 oz	18 mm	EARB118	EALLC18	EASC18
2 oz	18 mm	EARB218	EALLC18	EASC18
4 oz	24 mm	EARB424	EALLC24	EASC24
8 oz	24 mm	EARB824	EALLC24	EASC24
16 oz	28 mm	EARB1628	-	EASC28

Dispensing Tips

Fisnar offers a large selection of high-quality dispense tips in a variety of lengths, sizes, and styles including PTFE-lined, flexible polypropylene, stainless steel, brush, blunt end, angled blunt end, and tapered.



These high-performance fluid delivery systems provide accurate deposits of a variety of materials to meet your dispensing needs.

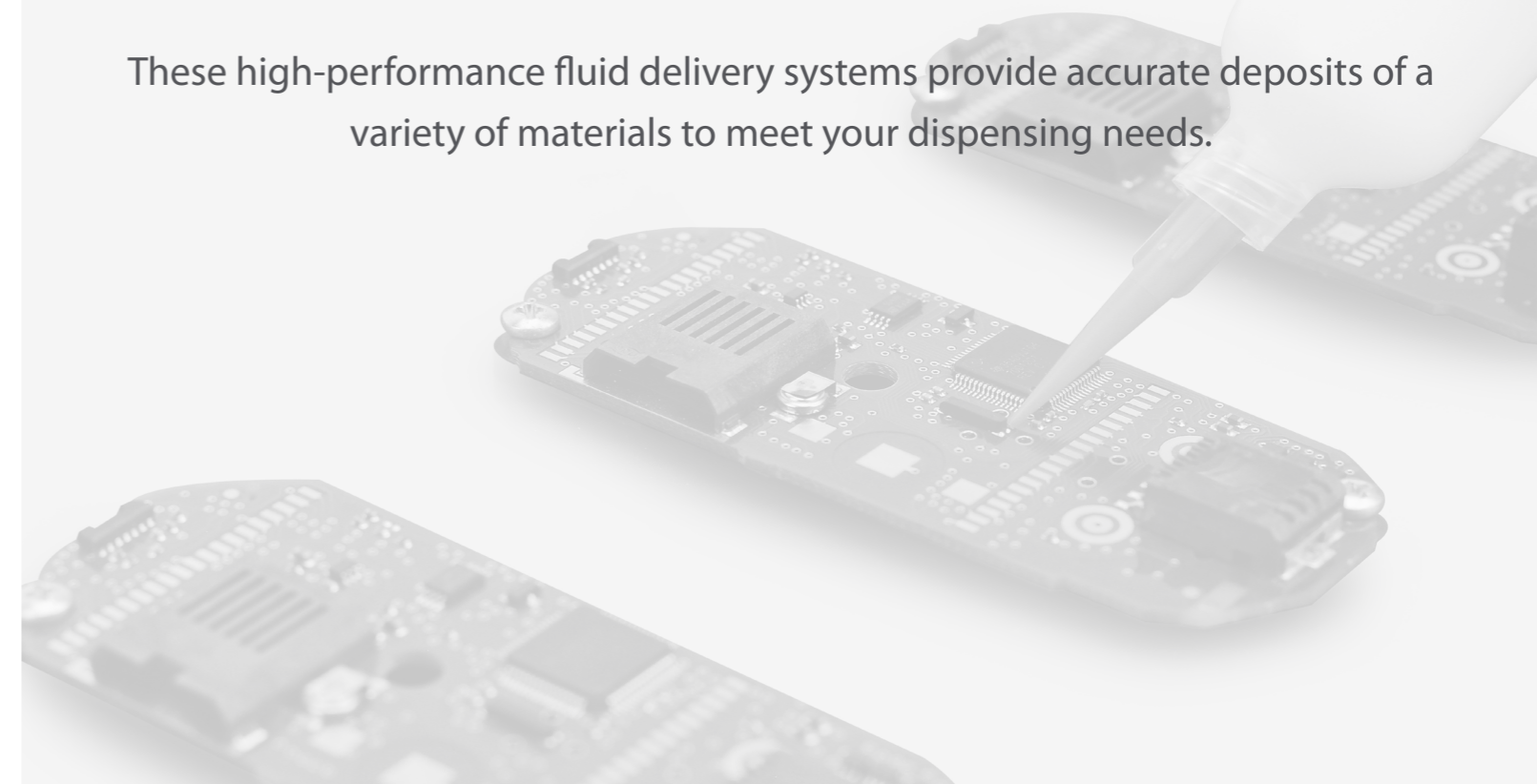

QK-NSK Tip Selection Kit

A selection of the most commonly used dispense tips (blunt end, tapered, PTFE lined, and flexible) in varying gauge sizes.



QuantX™ Blunt End Dispense Tips

Blunt end tips are manufactured with polypropylene hubs and stainless steel cannulas. A double helix luer lock design and polished burr-free finish ensure precision fluid dispensing. For dispensing low to high viscosity fluids in general purpose dispense applications.

QuantX™ Tapered Dispense Tips

Tapered smooth flow dispensing tips are designed to reduce back pressure of high-viscosity fluids resulting in an increased fluid flow rate. A uniform polypropylene luer lock design with a flash-free outlet ensures consistent fluid dispensing.

QuantX™ PTFE-Lined Dispense Tips

Stainless steel cannulas with an internal PTFE lining, projecting approximately 1/8" (3.18 mm) from the cannula. Ideal for dispensing very low-viscosity fluids, solvents, and cyanoacrylates.

QuantX™ Flexible Dispense Tips

Polypropylene flexible dispense tips are designed to be used in hard-to-reach areas and to prevent scratching or damage to fragile dispense surfaces.

QK-NSK Tip Selection Kit

Color	Gauge	Item Number	Description	Quantity
Olive	14	8001269	Single Tapered	2 ea
Gray	16	8001270	Single Tapered	2 ea
Green	18	8001271	Single Tapered	2 ea
Pink	20	8001272	Single Tapered	2 ea
Blue	22	8001273	Single Tapered	2 ea
Red	25	8001274	Single Tapered	2 ea
White	27	8001298	Single Tapered	2 ea
Lavender	30	8001276	Single Tapered	2 ea
Yellow	32	8001083	1/4" Blunt End	2 ea
Olive	14	8001084	1/2" Blunt End	2 ea
Amber	15	8001085	1/2" Blunt End	2 ea
Black	16	8001086	1/2" Blunt End	2 ea
Green	18	8001087	1/2" Blunt End	2 ea
Pink	20	8001088	1/2" Blunt End	2 ea
Purple	21	8001089	1/2" Blunt End	2 ea
Blue	22	8001090	1/2" Blunt End	2 ea
Orange	23	8001091	1/2" Blunt End	2 ea
Red	25	8001092	1/2" Blunt End	2 ea
Clear	27	8001093	1/2" Blunt End	2 ea
Lavender	30	8001094	1/2" Blunt End	2 ea
Gray	-	8001252	1/2" PTFE-Lined Tip	1 ea
Pink	-	8001253	1/2" PTFE-Lined Tip	1 ea
Gray	-	8001254	1" PTFE-Lined Tip	1 ea
Pink	-	8001255	1" PTFE-Lined Tip	1 ea
Olive	14	8001285	1/2" Flexible	1 ea
Amber	15	8001286	1/2" Flexible	1 ea
Green	18	8001287	1/2" Flexible	1 ea
Pink	20	8001288	1/2" Flexible	1 ea
Blue	22	8001289	1/2" Flexible	1 ea
Red	25	8001290	1/2" Flexible	1 ea

QuantX™ Blunt End Dispense Tips

A full selection of UV-bonded dispense tips manufactured with polypropylene hubs and stainless steel cannulas. A double helix luer lock design and polished burr-free finish ensure precision fluid dispensing. For dispensing low to high viscosity fluids in general purpose dispense applications.



Color	Gauge	I.D. (inch)	I.D. (mm)	1/4" (6.35 mm)	1/2" (12.7 mm)	1" (25.4 mm)	1 1/2" (38.1 mm)	45 Degree	90 Degree
Navy Blue	12	0.089	2.27	8001118	8001123	8001131	8001138	-	-
Magenta	13	0.070	1.78	8001119	8001124	8001132	8001139	-	-
Olive	14	0.063	1.60	8001115	8001084	8001095	8001105	8001156	8001166
Amber	15	0.054	1.37	8001073	8001085	8001096	8001106	8001157	8001167
Black	16	0.047	1.20	8001074	8001086	8006031	8001495	8001802	-
White	17	0.041	1.04	8001120	8001125	8001133	8001140	-	-
Green	18	0.033	0.84	8001075	8001087	8001097	8001107	8001158	8001168
Brown	19	0.028	0.70	8001121	8001126	8001134	8001141	-	-
Pink	20	0.024	0.60	8001076	8001088	8001098	8001108	8001159	8001169
Purple	21	0.020	0.51	8001077	8001089	8001099	8001109	8001160	8001170
Blue	22	0.016	0.41	8001078	8001090	8001100	8001110	8001161	8001171
Orange	23	0.013	0.33	8001079	8001091	8001101	8001111	8001162	8001172
Sky Blue	24	0.012	0.31	8001122	8001127	8001135	8001142	-	-
Red	25	0.010	0.25	8001080	8001092	8001102	8001112	8001163	8001173
Beige	26	0.009	0.23	8001128	8001463	8001136	8001143	-	-
Clear	27	0.008	0.20	8001081	8001093	8001103	8001113	8001164	8001174
Gray	28	0.007	0.19	8001129	8001130	8001137	8001144	-	-
Lavender	30	0.006	0.15	8001082	8001094	8001104	8001114	8001165	8001175
Yellow	32	0.004	0.10	8001083	8001117	-	-	-	-
Turquoise	33	0.004	0.10	8001116	-	-	-	-	-

QuantX™ Single Tapered Dispense Tips

Tapered smooth flow dispensing tips are designed to reduce back pressure of high-viscosity fluids resulting in an increased fluid flow rate. A uniform polypropylene luer lock design with a flash-free outlet ensures consistent fluid dispensing.

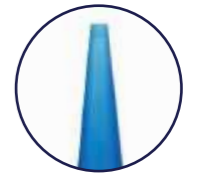

Standard Single Tapered UV Blocking

Color	Gauge	I.D. (inch)	I.D. (mm)	Length (inch/mm)	Item Number
Lime Green	10	0.118	3.00	1.25/32	8001217
Yellow	11	0.098	2.50	1.25/32	8001218
Sky Blue	13	0.079	2.00	1.25/32	8001219
Olive	14	0.063	1.60	1.25/32	8001269
Amber	15	0.054	1.37	1.25/32	8001220
Gray	16	0.047	1.20	1.25/32	8001270
Green	18	0.033	0.84	1.25/32	8001271
Pink	20	0.024	0.60	1.25/32	8001272
Purple	21	0.020	0.51	1.25/32	8001221
Blue	22	0.016	0.41	1.25/32	8001273
Orange	23	0.013	0.33	1.25/32	8001222
Red	25	0.010	0.25	1.25/32	8001274
White	27	0.008	0.20	1.25/32	8001298
Lavender	30	0.006	0.15	1.25/32	8001276

QuantX™ Double Tapered Dispense Tips

Double tapered tips feature a unique fluid outlet design to reduce fluid wicking and dripping with low-viscosity materials.



Color	Gauge	I.D. (inch)	I.D. (mm)	Length (inch/mm)	Item Number
Orange	14	0.063	1.60	1.25/32	8001263
Gray	16	0.047	1.20	1.25/32	8001264
Green	18	0.033	0.84	1.25/32	8001265
Pink	20	0.024	0.60	1.25/32	8001266
Blue	22	0.016	0.41	1.25/32	8001267
Red	24	0.014	0.37	1.25/32	8001268

QuantX™ UV & Light Block Dispense Tips

Used for dispensing medium to high viscosity fluids while blocking all UV and ambient light-emitting rays and wavelengths.



Color	Gauge	I.D. (inch)	I.D. (mm)	Length (inch/mm)	Item Number
Black	14	0.063	1.60	1.25/32	8001278
Black	16	0.047	1.20	1.25/32	8001281
Black	18	0.033	0.84	1.25/32	8001282
Black	20	0.024	0.60	1.25/32	8001283
Black	22	0.016	0.41	1.25/32	8001284
Black	25	0.010	0.25	1.25/32	8001279
Black	27	0.008	0.20	1.25/32	8001275

QuantX™ Flexible Dispense Tips

Polypropylene flexible dispense tips designed to be used in hard-to-reach areas and to prevent scratching or damage to fragile dispense surfaces.



Color	Gauge	I.D. (inch)	I.D. (mm)	1/2" (12.7 mm)	1 1/2" (38.1 mm)
Olive	14	0.063	1.60	8001285	8001291
Amber	15	0.054	1.37	8001286	8001292
Green	18	0.033	0.84	8001287	8001293
Pink	20	0.024	0.60	8001288	8001294
Blue	22	0.016	0.41	8001289	8001295
Red	25	0.010	0.25	8001290	8001296

QuantX™ PTFE-Lined Dispense Tips

Stainless steel cannulas with an internal PTFE lining, projecting approximately 1/8" (3.18 mm) from the cannula. Ideal for dispensing very low viscosity fluids, solvents, and cyanoacrylates.

Color	PTFE I.D. (inch/mm)	SS Tube O.D. (inch/mm)	1/2" (12.7 mm)	1" (25.4 mm)
Gray	0.024/0.61	0.042/1.06	8001252	8001254
Pink	0.011/0.28	0.32/0.80	8001253	8001255



DISPENSING CONSUMABLES

DISPENSING CONSUMABLES

QuantX™ Micron-S Precision Dispense Tips

Precision conical tips offer high accuracy, micro-dot dispensing due to their low-resistance, fluid flow design. These precision-machined tips have been specifically designed to improve flow rates and overall performance.

The thin rigid wall design enhances accuracy and definition of dots, lines, or special patterns while reducing fluid stringing or tailing tendencies. PTFE-coated versions reduce fluid wicking and dripping, and are compatible with anaerobic fluids.



Standard Bore



Micron Bore

Color	Gauge	I.D. (inch)	I.D. (mm)	O.D. (inch)	O.D. (mm)	Standard Bore	Micron Bore	PTFE Coated
Pink	18	0.041	1.039	0.049	1.24	5901001	-	5901012
Tan	19	0.034	0.859	0.042	1.059	5901002	-	5901013
Green	20	0.027	0.681	0.035	0.879	5901003	-	5901014
Lt. Blue	21	0.024	0.610	0.032	0.810	5901004	-	5901015
Purple	23	0.022	0.564	0.025	0.635	5901005	-	5901016
White	25	0.017	0.437	0.020	0.508	5901006	-	-
Red	27	0.013	0.335	0.016	0.406	5901007	-	-
Black	30	0.009	0.234	0.012	0.305	5901008	-	-
Blue	150 um	0.006	0.16	0.010	0.24	-	5901009	-
Orange	100 um	0.004	0.11	0.008	0.20	-	5901010	-
Yellow	50 um	0.002	0.06	0.006	0.16	-	5901011	-

QuantX™ Micron Selection Kit

Micron selection kit contains one each of the standard bore nozzle tip sizes for testing and validation purposes.

Item Number

QK-MSK

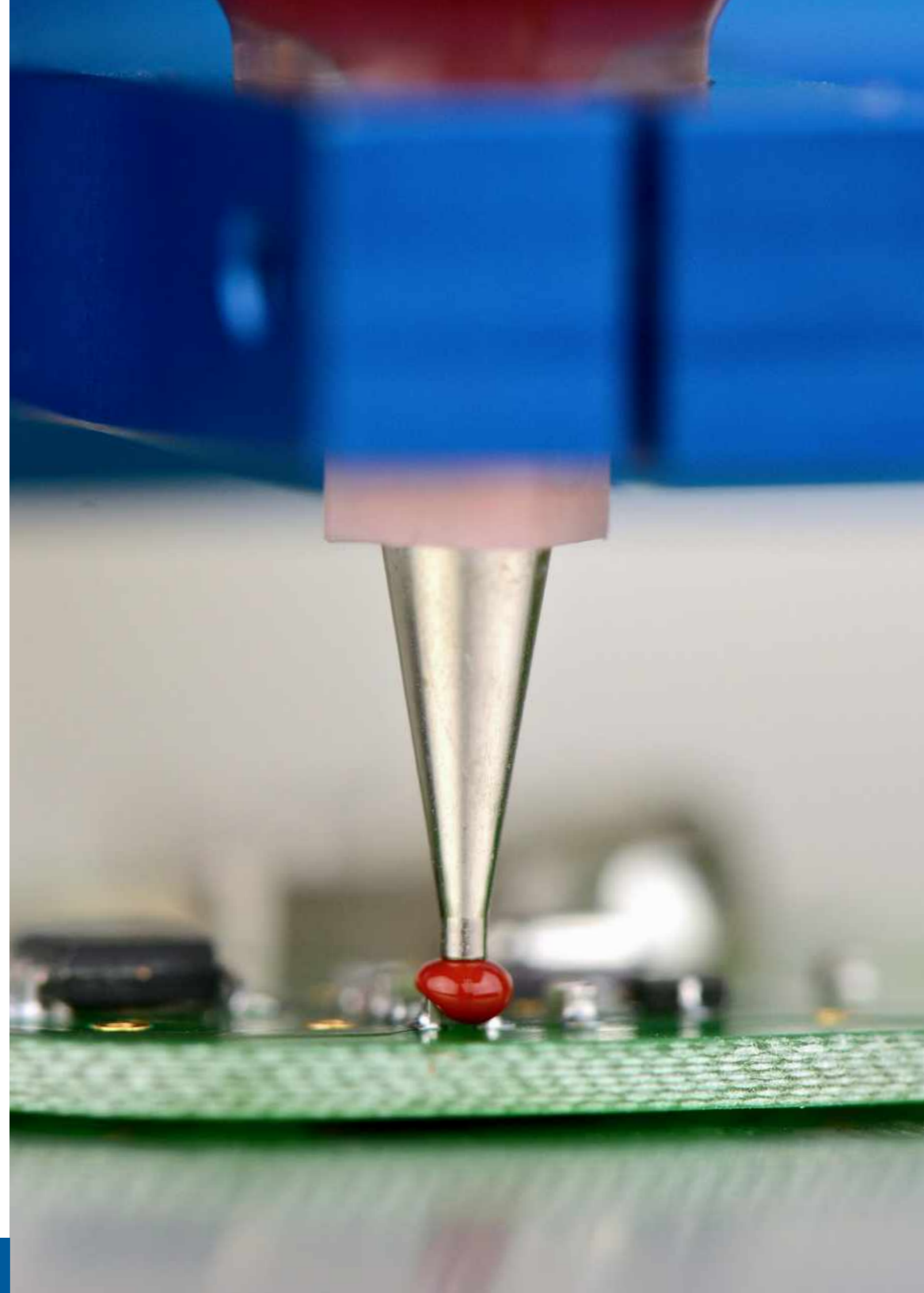

DISPENSING CONSUMABLES

Stainless Steel Dispense Tips

Stainless steel dispensing tips are available in single or double cannula designs. Each stainless steel tip consists of a precision stainless steel cannula and hub designed to fit standard luer lock connections.

This range of tips can be sterilized by an autoclave process for applications requiring sterile equipment.



Custom lengths and diameters are available upon request.

Single Cannula 1/2" Luer Lock

Gauge	I.D. (inch)	I.D. (mm)	Length (inch/mm)	1/2" (13 mm)
13	0.071	1.80	0.5/13	813050SS1
14	0.063	1.60	0.5/13	814050SS1
15	0.054	1.37	0.5/13	815050SS1
16	0.047	1.20	0.5/13	816050SS1
17	0.042	1.07	0.5/13	817050SS1
18	0.033	0.84	0.5/13	818050SS1
19	0.027	0.69	0.5/13	819050SS1
20	0.024	0.60	0.5/13	820050SS1
21	0.020	0.51	0.5/13	821050SS1
22	0.016	0.41	0.5/13	822050SS1
23	0.013	0.33	0.5/13	823050SS1
24	0.012	0.30	0.5/13	824050SS1
25	0.010	0.25	0.5/13	825050SS1
26	0.009	0.23	0.5/13	826050SS1
27	0.008	0.20	0.5/13	827050SS1
28	0.007	0.18	0.5/13	828050SS1
30	0.006	0.16	0.5/13	830050SS1

Double Cannula 3/4" Luer Lock

Gauge	I.D. (inch)	I.D. (mm)	Length (inch/mm)	3/4" (20 mm)
16	0.047	1.20	0.79/20	816050SS2
17	0.042	1.07	0.79/20	817050SS2
18	0.033	0.84	0.79/20	818050SS2
19	0.027	0.69	0.79/20	819050SS2
20	0.024	0.60	0.79/20	820050SS2
21	0.020	0.51	0.79/20	821050SS2
22	0.016	0.41	0.79/20	822050SS2
23	0.013	0.33	0.79/20	823050SS2
24	0.012	0.30	0.79/20	824050SS2
25	0.010	0.25	0.79/20	825050SS2
26	0.009	0.23	0.79/20	826050SS2
27	0.008	0.20	0.79/20	827050SS2

Stainless Steel Tip Selection Kit

Stainless steel single tip selection kit contains one of each of the sizes below for testing and validation purposes.

13, 14, 15, 18, 20, 21, 22, 23, 25, 26, 27, 30 gauges.



Large Bore Stainless Steel Dispense Tips (Long Length)

Available in Luer Lock and 1/4" NPT threaded connections, these large bore tips provide increased fluid flow rates or deposits when needed.

The long tube design allows for fluids to be easily dispensed into hard to reach areas which conventional dispense tips cannot reach.

Single Cannula Luer Lock Series

Gauge	I.D. (inch)	I.D. (mm)	1.5" (38 mm)	2.5" (64 mm)	3.5" (90 mm)
8	0.140	3.56	808150SS1	808250SS1	808350SS1
9	0.124	3.16	809150SS1	809250SS1	809350SS1
10	0.118	3.00	810150SS1	810250SS1	810350SS1
11	0.095	2.40	811150SS1	811250SS1	811350SS1
12	0.089	2.27	812150SS1	812250SS1	812350SS1
13	0.070	1.78	813150SS1	813250SS1	813350SS1
14	0.063	1.60	814150SS1	814250SS1	814350SS1
15	0.054	1.37	815150SS1	815250SS1	815350SS1



Single Cannula 1/4" NPT Series

Gauge	I.D. (inch)	I.D. (mm)	1.5" (38 mm)	2.5" (64 mm)	3.5" (90 mm)
7	0.143	3.64	807150T14	807250T14	807350T14
8	0.140	3.56	808150T14	808250T14	808350T14
9	0.124	3.16	809150T14	809250T14	809350T14
10	0.118	3.00	810150T14	810250T14	810350T14
11	0.095	2.40	811150T14	811250T14	811350T14
12	0.089	2.27	812150T14	812250T14	812350T14
13	0.070	1.78	813150T14	813250T14	813350T14
14	0.063	1.60	814150T14	814250T14	814350T14
15	0.054	1.37	815150T14	815250T14	815350T14



Brush Tips

Brush tips are designed for spreading, brushing, and applying greases, adhesives, and fluid materials. Tips contain either sable or nylon bristles and come in three styles: Type A, Type B, and Economy, depending on application requirements.

Type A



Gauge	Brush Diameter	Style	Item Number
16	10 mm	Flat Sable	5701265
18	10 mm	Flat Sable	5701266
22	10 mm	Flat Sable	5701267
16	5 mm	Round Nylon	5701268
18	5 mm	Round Nylon	5701269
22	5 mm	Round Nylon	5701270

Type B



Gauge	Brush Diameter	Style	Item Number
21	2 mm	Round Nylon	5702102
27	2 mm	Round Nylon	5702702
14	5 mm	Round Nylon	5701405
21	5 mm	Round Nylon	5702105
27	5 mm	Round Nylon	5702705
14	10 mm	Flat Nylon	5701410
21	10 mm	Flat Nylon	5702110
27	10 mm	Flat Nylon	5702710

Economy

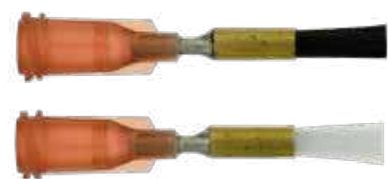

Gauge	Brush Diameter	Style	Item Number
15	3 mm	Round Soft Nylon	5701309
15	3 mm	Round Stiff Nylon	5701310

Brush Tip Selection Kit

Brush tip selection kits are available in two different options for testing and validation purposes. QK-BTK-A contains one of each Type A style brush tips. QK-BTK-B contains 1 of each Type B style brush tips.

Type	Item Number
A	QK-BTK-A
B	QK-BTK-B



Dipit™ Bottles

Dipit™ Touch-Pump bottles provide a clean method of delivery by conveniently presenting a small reservoir of solvent, cleaner, or alcohol.

Fluid-ready for dipping a brush or wipe for assembly, production, or laboratory purposes.

Ideal for PCB soldering operations and clean rooms. Prevents wasteful evaporation and contamination. Stainless steel lid and pump components.



Item Number	Description
5606026	4 oz Touch-Pump Bottle
5606027	8 oz Touch-Pump Bottle

Dipit™ Brushes

Item Number	Description
5701272	Dipit™ Brush Delrin 1/4" Nylon Soft
5701273	Dipit™ Brush Zinc/Steel 3/8" Bristle
5701274	Dipit™ Brush Dual Head 3/16" - 1/4" Hard



Flow-Seal Pens & Bottles

Flow-seal pens and bottles are designed to channel controlled amounts of no-clean flux, solvents, lubricants, masking, water-based liquids, and more.

Flow-seal products prevent evaporation of material and conform to current regulations for controlling substances capable of evaporation hazards.

**All pens and bottles come supplied with chisel nib 381-8425-AC.*



Features

- Priming is achieved by depressing the tip while the pen is vertical
- A unique dispensing valve prevents flooding and soaking by releasing material in controlled amounts
- Cap valve allows for easy removal of tips when cleaning or replacing
- Flow-seal pens are cost efficient as product is only delivered when required

Item Number	Description	Size	Material	Item Number	Description	Material
FV-0100	Flow-Seal Pen	0.34 oz/ 10 ml	HDPE (Clear)	381-8425-AC	Chisel Nib	Acrylic
FV-0200	Flow-Seal Pen (ESD Safe)	0.34 oz/ 10 ml	Aluminum	381-8425-AB	Bullet Nib	Acrylic
FV-0300	Flow-Seal Bottle	2 oz/ 59.14 ml	HDPE (Clear)	381-8425-AP	Pointed Nib	Acrylic
FV-0400	Flow-Seal Bottle (ESD Safe)	2 oz/ 59.14 ml	Aluminum	381-8425-PC	Chisel Nib	Polyester
FV-0500	Flow-Seal Bottle	4 oz/ 118.21 ml	HDPE (Clear)	381-8425-PB	Bullet Nib	Polyester
FV-0600	Flow-Seal Jumbo Pen	1.35 oz/ 40 ml	HDPE (Black)	381-600-PB	Blunt Tip (FV-0600 only)	Polyester

QuantX™ Nib Tip Sample Kit

The QK-NTK sample kit includes eight flow-seal nib tips including acrylic chisel, acrylic bullet, acrylic point, and polyester chisel.

Item Number	Description
QK-NTK	Nib Tip Sample Kit



Cartridges

High-quality, disposable cartridges provide a clean and efficient method to meet all types of production requirements. For use in a wide range of applications including pre-mixed and frozen materials, as well as prepackaged products.

Available in a variety of different sizes and capacities. Can be used with manual, handheld, or pneumatic air-powered equipment.

All cartridges are molded in either low or high-density polyethylene. Black cartridges are designed for use with UV and light curing fluids.



Item Number	Description	I.D. Diameter (inch/mm)	Overall Length (inch/mm)	Capacity (oz/ml)
EA25C-LD	Natural LDPE	1.59/40.40	4.00/101.60	2.5/74
EA60C-LD	Natural LDPE	1.59/40.40	7.11/180.60	6/177
EA80C-LD	Natural LDPE	1.59/40.40	8.92/226.60	8/237
EA120C-LD	Natural LDPE	1.59/40.40	12.34/313.40	12/355
EA110C-LD	Natural LDPE	1.85/47.00	8.99/228.30	12.8/310
EA25C-HD	Natural HDPE	1.59/40.40	4.00/101.60	2.5/74
EA60C-HD	Natural HDPE	1.59/40.40	7.11/180.60	6/177
EA80C-HD	Natural HDPE	1.59/40.40	8.92/226.50	8/237
EA120C-HD	Natural HDPE	1.59/40.40	12.34/313.40	12/355
EA110C-HD	Natural HDPE	1.85/47.00	8.99/228.30	12.8/310
EA200C-HD	Natural HDPE	2.57/65.30	10.03/254.80	20/591
EA25C-HD-BK	Black HDPE	1.59/40.40	4.00/101.60	2.5/74
EA60C-HD-BK	Black HDPE	1.59/40.40	7.11/180.60	6/177
EA80C-HD-BK	Black HDPE	1.59/40.40	8.92/226.50	8/237
EA120C-HD-BK	Black HDPE	1.56/40.40	12.34/313.40	12/355
EA110C-HD-BK	Black HDPE	1.85/47.00	8.99/228.30	12.8/310
EA200C-HD-BK	Black HDPE	2.57/65.30	10.03/254.80	20/590

Dispensing Nozzles

Dispensing nozzles are precision molded from polyethylene and have 1/4" NPT male threads to fit cartridges, valves, and other compatible equipment.



Standard Nozzles

Standard nozzles are designed to be used in applications requiring basic dispensing of beads and dots.



Item Number	Length (inch)	Diameter (inch)	Material
EA2160-HD	2	1/16	HDPE
EA2180-LD	2	1/8	LDPE
EA2180-HD	2	1/8	HDPE
EA4160-HD	4	1/16	HDPE
EA4160-LD	4	1/16	LDPE
EA4180-LD	4	1/8	LDPE
EA4320-HD	4	1/32	HDPE
EA4320-LD	4	1/32	LDPE
EA4900-LD	4	3/32	LDPE
EA6160-LD	6	1/16	LDPE
EA6180-LD	6	1/8	LDPE

Specialty Nozzles

Specialty nozzles are designed in a variety of styles for custom applications that require spreading, brushing, step filling, and more.



Item Number	Length (inch)	Dimension (inch)	Material	Nozzle Style
EA1050	4	1/2 x 1/16	HDPE	Spreader
EA1050-45	4	1/2 x 1/16	HDPE	45° Spreader
EA1075	4.5	3/4 x 1/8	HDPE	Spreader
EA1100	4.5	1 x 1/8	HDPE	Spreader
EA1175	4	1 3/4 x 1/8	HDPE	Spreader
EA3106	4	3/8 x 1/8	HDPE	Fillet Right Step
EA3206	4	3/8 x 1/8	HDPE	Fillet Left Step

Cartridge Plungers

The use of plungers ensures even pressure is applied on the fluid, while also preventing tunnelling of air to achieve controlled and repeatable dispense results. The plungers' wipe clean design maximizes fluid usage from within the cartridge. Plungers are available in low or high-density polyethylene and come in a variety of sizes to fit compatible cartridges.

Item Number	Color	Description
EA1WP-LD-NT	Natural	2.5, 6, 8, 12 oz - Wiper LDPE
EA1WP-LD-BL	Blue	2.5, 6, 8, 12 oz - Wiper LDPE
EA1WP-LD-BK	Black	2.5, 6, 8, 12 oz - UV Blocking Wiper LDPE
EA110WP-LD-NT	Natural	1/10th gallon - Wiper LDPE
EA200WP-LD-NT	Natural	20 oz - Wiper LDPE
EA200WP-HD-NT	Natural	20 oz - Wiper HDPE



Cartridge Caps

End and tip caps are designed to seal out air for proper storage and handling purposes. Available in snap on, push on, and threaded styles.

Item Number	Description
EA2C	2.5, 6, 8, 12 oz - End Cap LDPE
EA110CP	1/10th gallon - End Cap LDPE
EA6C	20 oz - End Cap LDPE
EA3P	Threaded Tri-Seal Cap PE
EA4P	Threaded Tip Cap PE
EA5P	Snap On Tri-Seal Tip Cap PE
EA9X	Snap On Tip Cap PE



Cartridge Tip Adapters

Allows for the use of QuantX™ dispense tips with luer lock hubs. 1/4" NPT tip adapters for use with cartridges and valves fitted with 1/4" NPT female threads.

Item Number	Description
5801420	Tip Adapter - Metal
5801449	Tip Adapter - Black Polypropylene
5801450	Tip Adapter - White Polypropylene



Cartridge Retainers & Caps

Heavy duty, light-weight aluminum and nylon retainers can withstand up to 100 psi (6.9 bar) pressure. Cartridge retainers accommodate all corresponding cartridge sizes. *Retainer caps sold separately.*

Item Number	Description
918-030-000	74 ml/2.5 oz Cartridge Retainer
918-031-000	177 ml/6 oz Cartridge Retainer
918-034-000	237 ml/8 oz Cartridge Retainer
918-032-000	355 ml/12 oz Cartridge Retainer
5601376	Retainer Cap with Sealing Ring/Fittings
5601377	Retainer Cap with Regulator Gauge
5601378	Seal for Retainer Cap
5601357	Connecting Hose (5 ft)

Metal Cartridge Retainers



Item Number	Description
5801379	2.5 oz Cartridge Retainer Body
5801380	6 oz Cartridge Retainer Body
5801381	8 oz Cartridge Retainer Body
5801382	12 oz Cartridge Retainer Body
5801376-SEAL	Seal for Retainer Cap
5801376	Retainer Screw Cap with Fittings
5801377	Retainer Cap with Regulator Gauge
5601357	Connecting Hose (5 ft)

Nylon Cartridge Retainers



Cartridge Retainer Stands

Item Number	Description
560535	2.5, 6, 8, 12 oz Metal Retainer Cartridge Stand
560535-NU	2.5, 6, 8, 12 oz Nylon Retainer Cartridge Stand



1/10th Gallon Plastic Retainer & Cap

The 580091H-A is an economical retainer designed to dispense from standard caulking cartridges. Dispensing can be delivered with fine gauge luer lock tips or with larger nozzles. Dispensing pressure should not exceed 65 psi (4.48 bar).

Item Number	Description
580091H-A	Plastic Cartridge Retainer Assembly (Retainer, Cap, Seals, and Hose)
580091H-CF	1/10th gallon Cap with Fittings
5601357	Connecting Hose (5 ft)
560655	Rubber Seal
562027	Plastic Spacer



Nylon Cartridge Retainer Assemblies

Durable, nylon molded, screw cap retainers are lightweight and can withstand up to 100 psi (6.9 bar) pressure. Cartridge retainers accommodate 2.5, 6, 8, and 12 oz cartridges. Compatible with Techcon, Semco, and EFD-style cartridge systems. Retainer, cap, and hose complete with each kit.

Item Number	Description
5801379-KIT	2.5 oz Cartridge Retainer Assembly with Hose
5801380-KIT	6 oz Cartridge Retainer Assembly with Hose
5801381-KIT	8 oz Cartridge Retainer Assembly with Hose
5801382-KIT	12 oz Cartridge Retainer Assembly with Hose
5801376	Retainer Screw Cap with Fittings
5601357	Connecting Hose (5 ft)



Cartridge Retainer Stands

Item Number	Description
560535-NU	2.5, 6, 8, 12 oz Nylon Retainer Cartridge Stand



CR300 1/10th Gallon Cartridge Retainer

The CR300 was developed with a new seal design, for greater seal performance and durability by sealing directly onto the inside of the inserted cartridge.

Fully compatible with 1/10th gallon plastic and metal caulking type cartridges (300/310 ml). This high-grade anodized alloy retainer and cap ensures a safe, comfortable dispensing pressure of up to 100 psi (6.9 bar).

With high performance and unique versatility, this retainer can be used as a pressurized fluid reservoir system in conjunction with a Fisnar dispense valve.

Hose included standard with CR300.

Features

- Supplied with a universal air-inlet for effortless system installation and integration
- Designed for long lasting use
- Quick and easy screw on cap can be attached directly to a Fisnar air-powered dispenser
- Optimized tube design reduces cartridge expansion while decreasing risk of air ingress into the fluid
- Works efficiently with 1/10th gallon cartridge adapter nuts to convert the male thread on a standard caulking type cartridge to a conventional female 1/4" NPT thread

Cartridge Adapter Nuts

Used for converting male thread on a 310 ml (1/10th gallon) cartridge to a 1/4" NPT female thread. 1/4" NPT nozzles, tip adapters, or fittings can be connected to allow material dispensing directly from the cartridge.

Item Number	Description
561129-SS	Cartridge Adapter 1/4" NPT x 5/8"-11 UNC 316 Stainless Steel
561129	Cartridge Adapter 1/4" NPT x 5/8"-11 UNC White Acetal
562317	Cartridge Adapter 1/4" NPT x 13/16-14 UNC Black Acetal
560546	Cartridge Adapter 1/4" NPT Female Polyethylene



*560549U stand sold separately.

Item Number	Description
CR300	Cartridge Retainer Assembly (Retainer, Cap, Seals, and Hose)
CR300-SEAL	Retainer Cap Sealing Ring
560549U	Cartridge Retainer Stand
562146	Quick Connect Hose (6 ft)

Accessories (Sold Separately)

Item Number	Description
560549U	Cartridge Retainer Stand
562146	Quick Connect Hose (6 ft)



CR570 20 oz Cartridge Retainer

The CR570 Cartridge Retainer has been designed for use with Techcon, Semco, and EFD 20 oz plastic cartridges. The new seal design delivers greater performance and durability by sealing directly onto the inside of the inserted cartridge.

The high grade anodized aluminium retainer and cap provide a safe dispensing pressure of up to 100 psi (6.9 bar). The high performance heavy duty design also makes this system ideal for use in industrial environments and ensures long lasting use.

Hose included standard with CR570.

Features

- Compatible for use with Techcon, Semco, and EFD 20 oz cartridges
- Machined slots in retainer body allow for the fluid level inside the inserted cartridge to be easily monitored
- Optimized tube design reduces cartridge expansion while decreasing the risk of air ingress into the fluid
- Quick connect air-inlet connector allows for the safe removal of compressed air from the retainer when replacing the cartridge
- Can be attached directly to a Fisnar dispense controller or used as a valve fluid feed system/reservoir



*560534U stand sold separately.

Item Number	Description
CR570	Cartridge Retainer Assembly (Retainer, Caps, Seals, and Hose)
CR570-SEAL	Retainer Cap Sealing Ring
562146	Quick Connect Hose

Accessories (Sold Separately)

Item Number	Description
560534U	20 oz Cartridge Retainer Stand

Manual & Pneumatic Cartridge Dispensers

A range of manual and pneumatic dispensers for use with most standard and prefilled cartridges.

- FMG-25, FLG-25, FPG-25, FMG-60, FLG-60, FPG-60, FMG-80, FLG-80, FPG-80, FMG-120, FLG-120, and FPG-120 dispenser kits are compatible with Techcon, Semco, and EFD-style 2.5, 6, 8, and 12 oz cartridge systems
- FMG-25T, FMG-60T, FMG-80T, and FMG-120T dispenser kits are compatible with Techcon style 2.5, 6, 8, and 12 oz cartridge systems
- FPG-300 dispenser kit is compatible with all standard plastic 1/10th gallon (300 ml) caulking-style cartridge systems



Manual Dispensers - Nylon Retainer

Item Number	Description
FMG-25	2.5 oz Manual Dispenser Kit
FMG-60	6 oz Manual Dispenser Kit
FMG-80	8 oz Manual Dispenser Kit
FMG-120	12 oz Manual Dispenser Kit



Manual Dispensers - Metal Retainer

Item Number	Description
FMG-25T	2.5 oz Manual Dispenser Kit
FMG-60T	6 oz Manual Dispenser Kit
FMG-80T	8 oz Manual Dispenser Kit
FMG-120T	12 oz Manual Dispenser Kit



Lever Actuated Dispensers - Nylon Retainer

Item Number	Description
FLG-25	2.5 oz Lever Actuated Dispenser Kit
FLG-60	6 oz Lever Actuated Dispenser Kit
FLG-80	8 oz Lever Actuated Dispenser Kit
FLG-120	12 oz Lever Actuated Dispenser Kit



Pistol Grip Dispensers - Nylon Retainer

Item Number	Description
FPG-25	2.5 oz Lever Actuated Dispenser Kit
FPG-60	6 oz Lever Actuated Dispenser Kit
FPG-80	8 oz Lever Actuated Dispenser Kit
FPG-120	12 oz Lever Actuated Dispenser Kit
FPG-300	300 ml Pistol Grip Dispenser Kit (Metal Retainer)



Manual Barrel Loaders

The 560548U Series of manual barrel loaders will fill a barrel directly from a 6 oz, 12 oz, 20 oz, or 300 ml cartridge.

Barrel loaders are connected to an air regulator and set to a pressure suitable for the material not exceeding 65 psi (4.48 bar). A manual switch on the base actuates the air supply and pressurizes the cartridge to fill the syringe barrel.

The barrel fillers' internal air relief valve allows for decompression when the trigger is released. The system can be used for timed filling when connected to a Fisnar automatic controller.



Item Number	Description
-------------	-------------

560548U-6N	6 oz Nylon Barrel Loader
560548U-12N	12 oz Nylon Barrel Loader
560548U-300	300 ml Metal Barrel Loader
560548U-570	20 oz Metal Barrel Loader

Replacement Parts

Item Number	Description
-------------	-------------

561105	1/4" NPT Elbow
5801451	Syringe Filling Adapter
560710	Luer Lock Cap
560546	1/4" NPT Polyethylene Female Cartridge Adapter
561129	1/4" NPT x 5/8-11 UNC White Acetal Cartridge Adapter
562317	1/4" NPT x 13/16-14 UNC Black Acetal Cartridge Adapter

Syringe barrel and piston sold separately.



Liquid Dispensers



SL101N Standard Dispenser

An automatic digital dispenser with a bright LCD display and "teach and learn" process programming feature. Up to 9 independent dispensing programs may be stored for fast recall.

Modes:

Manual Mode: The dispense operation is manually controlled by a foot pedal.

Timed Mode: Dispenses at a pre-set time.

Auto Cycling Mode: Combines a dispense time and pause time and will continue to repeat the cycle until foot pedal is actuated.



Push-to-connect style fitting standard on SL101N controller.

Features

- Digital timer for precise and repeatable dispense control
- Durable aluminum housing designed for industrial work environments
- Vacuum suck-back control to prevent fluid dripping from dispense tip
- 9 programmable memory storage locations

Item Number	Description
SL101N	Standard Digital Dispenser

Specifications

Dispense Time	0.01 - 9999s
Cycle	Manual, Timed, Cycle
Internal Memory	9 save locations
Air Input	70 - 100 psi
Air Output	1 - 100 psi
Voltage	100 - 240 VAC, 50/60 Hz
Dimensions (WxDxH)	219.2 x 215.9 x 66.8 mm (8.63 x 8.50 x 2.63")
Weight	1.59 kg (3.5 lb)
Standards	RoHS



Item Number	Description
560021U	Syringe Barrel Stand <i>Stand sold separately.</i>

DC50 General Purpose Dispenser

A general purpose, easy to use digital dispenser with a bright 4-digit LED display. The simple, user friendly programming enables a dispense cycle to be quickly created and automatically displayed.

Modes:

Manual Mode: The dispense operation is manually controlled by a foot pedal.

Timed Mode: Dispenses at a pre-set time for controlled, repeatable shot sizes.



Push-to-connect style fitting standard on DC50 controller.

Features

- 1 programmable memory slot
- 0-100 psi pressure regulator gauge
- 2 dispense modes (manual & timed)
- Worldwide compatible power supply
- 4 digit LED display (0 to 9999s)
- Durable aluminum housing designed for industrial work environments
- Simple, compact & easy to use design

Item Number	Description
DC50	General Purpose Digital Dispenser

Specifications

Input AC to Power Supply	100 - 240 VAC, 50/60 Hz
Output DC from Power Supply	24 VDC - 1 Amp
Cycle Rate	Up to 600 cycles/min
Relative Humidity	20 - 90% (No Condensation)
Operating Temperature	50 - 104 °F (10 - 40 °C)
Timer	0.008 - 99.99s
Air Input	100 psi (7 bar) max
Air Output	1 - 100 psi (0.07 - 7 bar)
Dimensions (WxDxH)	192 x 128 x 76 mm (7.56 x 5.04 x 3.00")
Weight	0.97 kg (2.14 lb)
Standards	CE Approved, RoHS Compliant



Item Number	Description
560021U	Syringe Barrel Stand <i>Stand sold separately.</i>

DC100 High Precision Dispenser

A versatile, high precision dispenser designed to suit a wide variety of dispensing applications: from microdot deposits and lines, to large potting and filling. Integral and intelligent dispense software allows the user more control over dispensing applications.

Programmable alarms can be set to notify the user when material life has ended or fluctuations in dispensing pressure have occurred. The user-friendly programming allows for up to 10 saved programs and 5 different dispense modes.



Push-to-connect style fitting standard on DC100 controller.

Features

- 10 programmable memory slots
- Air input alarm can be set for monitoring consistent air input pressure, 5 dispense modes (purge, teach, timed, time+, Int.)
- Worldwide compatible power supply
- Multilingual display
- Digital display (time, pressure, vacuum)
- Dispense cycle counter
- Programmable alarms
- Internal pressure and vacuum calibration function
- Selectable pressure and vacuum measurement units

Item Number	Description
DC100	High Precision Digital Dispenser

Specifications

Cycle Rate	600+ cycles/min
Dispense Time	0.008 - 9999s
Programs	10 Memory Slots
Input AC to Power Supply	100 - 240 VAC, 50/60 Hz
Output DC from Power Supply	24 VDC - 0.75 Amp
Air Input	70 - 100 psi (7 bar) max
Air Output	1 - 100 psi (0.07 - 7 bar)
Operating Temperature	50 - 104 °F (10 - 40 °C)
Relative Humidity	20 - 90% (No Condensation)
Dimensions (WxDxH)	191.3 x 179.1 x 71.9 mm (7.53 x 7.05 x 2.83")
Weight	0.92 kg (2 lb)
Standards	CE Approved, RoHS Compliant



Item Number	Description
560021U	Syringe Barrel Stand <i>Stand sold separately.</i>

Pistol Grip Switch Assemblies

The pistol grip electronic switch assembly is designed to hold a metal cartridge retainer or 790HP valve. Allows better dispense control while reducing operator fatigue. Comes in two 3-pin configurations depending on controller connection point in back of unit.

Cartridge Pistol Grip Assembly

Item Number	Description
560598	For use with SL101N
560598DC	For use with DC50/DC100/DC200

790HP Valve Pistol Grip Assembly

Item Number	Description
560565	For use with SL101N
560565DC	For use with DC50/DC100/DC200



Metal retainer and 790HP valve sold separately.

Finger Switches

Designed for use in situations where it is not convenient to use a foot pedal or for operators who prefer finger switches when actuating the dispense controller. These finger switches are easily adjustable and can be fitted to a wide range of cartridges, retainers, and barrels.

Cartridge Retainer Switches

Item Number	Description
FS-501V	For use with SL101N
FS-501VDC	For use with DC50/DC100/DC200

Barrel Switches

Item Number	Description
560023-LF	For use with SL101N
560023-LFDC	For use with DC50/DC100/DC200



Metal retainer, syringe barrel, and receiver head sold separately.

PPD-130 Peristaltic Pump Dispenser

Peristaltic pump dispensers transfer low-viscosity liquids by pressure displacement applied to a turning rotor against a tube-carrying fluid.

The PPD-130 offers excellent features for air-free positive displacement dispensing of materials, such as cyanoacrylates, solvents, acids, and other low-viscosity fluids.

Dispense outputs can be timed from 0.01 to 99.99 seconds with flow speeds from 0.01 to 6 ml/min using PTFE tubing. The pump is bidirectional allowing snuff-back after discharge to prevent dripping.



Item Number	Description
PPD-130	Peristaltic Pump Dispenser

Specifications

Cycle Rate	0.01 - 99.99s
Flow Speed	0.01 - 6 ml/min
Rotor Speed	Up to 120rpm
Dispense Pressure	Over 105 kg/cm ²
I/O	Connection for Remote Operation
Input Voltage	110 - 240 VAC, 50/60 Hz
Dimensions (WxDxH)	182.4 x 81.3 x 170.9 mm (7.18 x 3.20 x 6.73")
Weight	2.99 kg (6.6 lb)
Standards	CE Approved, RoHS Compliant

Features

- Forward and reverse motion
- Adjustable interval before reverse direction
- Continuous or timed modes
- Output signal to indicate end of cycle
- Large segment digital LED display
- Air-free dispensing
- Instant reverse for snuff-back of liquid flow

PPD-130 Accessories

The PPD-130 comes with a range of accessories, tubing, and nozzles. Optional pump heads and foot pedal available for advanced application requirements. Comes supplied with standard pump head 562030-T.

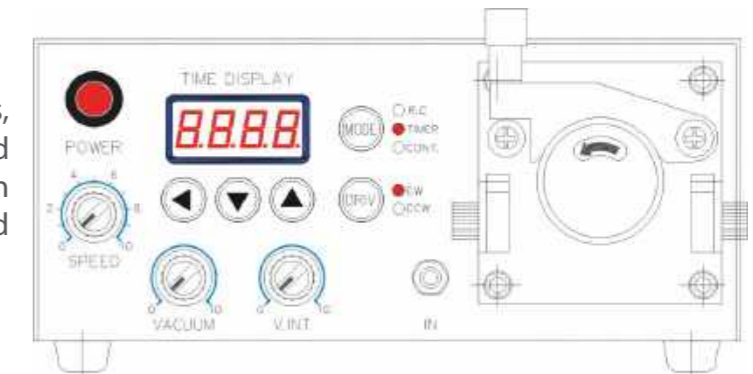

Included Accessories

Item Number	Description	Item Number	Description
560989-D	Nozzle Holder (with switch)	560984P-10FT	10 ft (304.8 mm) 1.0 x 1.6 mm
561010-D	Nozzle 1.7 mm diameter	560985P-10FT	10 ft (304.8 mm) 1.4 x 2.0 mm
561011-D	Nozzle 2.1 mm diameter	560995P-10FT	10 ft (304.8 mm) 1.9 x 2.5 mm
561012-D	Nozzle 2.6 mm diameter	560996A-10FT	10 ft (304.8 mm) 2.4 x 3.0 mm
561013-D	Nozzle 3.5 mm diameter	562031-D	9-pin connector

Sold Separately

Item Number	Description
562032-D	Foot Pedal (optional)

Tubing, Nozzles & Optional Pump Heads

Standard Pump Head

Item Number	Clear Tubing	Black Tubing	I.D. x O.D. (mm)	Suitable Nozzle Type	Nozzle Dimensions
562030-T	560984P-10FT	560984BA-10FT	1.0 x 1.6	561010-D	1.7 mm
562030-T	560985P-10FT	560985BA-10FT	1.4 x 2.0	561011-D	2.1 mm
562030-T	560995P-10FT	560995BA-10FT	1.9 x 2.5	561012-D	2.6 mm
562030-T	560996A-10FT	560996BA-10FT	2.4 x 3.0	561013-D	3.5 mm

Optional Pump Head

Item Number	Clear Tubing	Black Tubing	I.D. x O.D. (mm)	Suitable Nozzle Type	Nozzle Dimensions
562030-M	560997P-10FT	560997BA-10FT	0.25 x 0.75	-	-
562030-S	560998A-10FT	560998BA-10FT	0.50 x 1.00	561008-D	0.9 mm
562030-S	560999A-10FT	560999BA-10FT	0.60 x 1.00	-	-

ATD200C Autotube Dispense Kit

The autotube system was designed to dispense liquids, pastes, greases, silicones, and similar materials directly from the manufacturer's collapsible metal tubes (max size 1.5" diameter x 7.25" length).

Dispensing is controlled by either a foot valve or timed dispenser for a controlled shot.

The autotube assembly can be handheld, utilized with pistol grip handle, or mounted on a stand.



Features

- Eliminates waste
- Improves operator safety
- Prevents tube damage
- Clean and easy dispense method
- Reduces risk of contamination

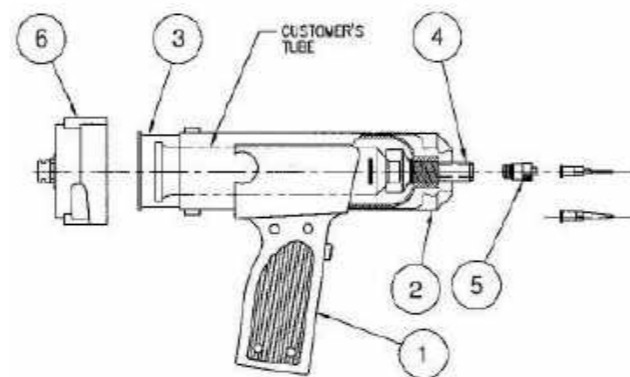

ATD200C

Item Number	Description	Reference ID
5601357	Connecting Hose (5 ft)	-
560517A	8 oz Cartridge	3
918-034-000	8 oz Cartridge Retainer	2
5601376	Retainer Cap	6
A-10001-OT	Luer Lock Tip Adapter	5
880001-A	Adapter M13x1	4
880001-B	Adapter M14x2	4
880001-C	Adapter M12x1.75	4
880001-D	Adapter M18x1.25	4
880001-BLANK	No Thread Adapter	4
QK-NSK	Needle Selection Kit	-

Pistol Grip Handles (sold separately)

560598DC

560598

Use with DC-style Controllers

Use with non-DC-style Controllers



TD101 Pneumatic Tube Dispenser

The TD101 dispenser is engineered to specifically address the waste and discomfort that result from dispensing materials in collapsible tubes. Its comfortable, balanced design protects the tube from damage and the operator from material contact.



Item Number	Description
TD101	Pneumatic Tube Dispenser

Features

- Eliminates waste when dispensing from tubes
- Avoids material contamination
- Improves operator safety
- Prevents tube damage

Dispensing Configurations:

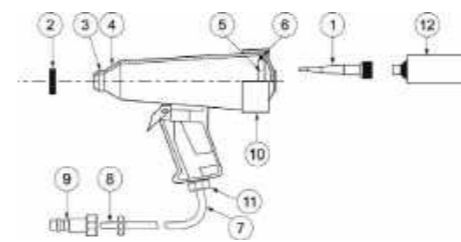

Using the Supplied Nozzle

Item Number	Description	Reference ID
910-TN	Nozzle	1
560699	Nozzle Nut	2
560698	O-Ring	3
560697	Lock Ring	4
560696	Retaining Ring	5
560695	Seal	6
560702	Cap Only	10
-	Tube (not included)	12

Specifications

Maximum Tube Size	7.38"
Cycle	Manual (trigger actuated)
Start Pressure	Recommended 20 psi (1.38 bar)
Maximum Pressure	50 psi (3.45 bar)
Size	190.5 x 76.2 x 171.5 mm (7.5 x 3 x 6.75")
Weight	272 g (0.6 lb) without tube

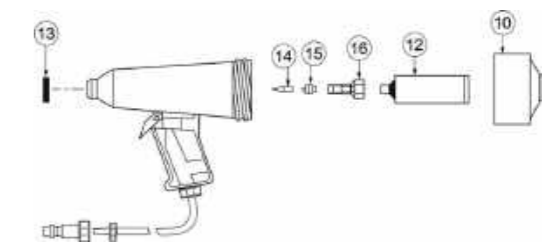

Using with Luer Lock Tips

Item Number	Description	Reference ID
560707	Adapter Nut	13
880001-A	Adapter M13 x 1	16
880001-B	Adapter M14 x 2	16
880001-C	Adapter M12 x 1.75	16
880001-D	Adapter M18 x 1.25	16
880001-BLANK	No Thread Adapter	16
QK-NSK	Needle Selection Kit	Not Shown
A-10001-OT	Luer Lock Adapter	5
560702	Cap Only	10
-	Tube (not included)	12



DTD50 50 ml Dispenser

The DTD50 is a pneumatically controlled dispense tool for precisely dispensing two component materials packaged into 50 ml dual cartridges.

With its simple design and operation, accurate and repeatable fluid deposits are quickly and easily created when connected to a dispense controller.



DC100 controller, cartridge, and mix nozzle sold separately.

Item Number	Description
DTD50	50 ml Dispenser Square Back
DTD50-RB	50 ml Dispenser Round Back (S-Flange)



DTD50 for use with square back cartridges



DTD50-RB for use with round back cartridges

Features

- Lightweight and durable design
- Use as a handheld device or mounted on a stand or robot for hands-free dispensing
- Suitable for all ratio sizes including: 1:1, 2:1, 4:1, and 10:1

Specifications

Air Input	1 - 100 psi (6.9 bar)
Dimensions	139.7 x 58.4 mm (5.5 x 2.3")
Weight	280 g (0.6 lb)
Material	Aluminum and Acetal

Dispensing Configurations:

Finger Switch Actuated
(FS-501V or FS-501VDC)



Pistol Grip Hand Assembly
(560565 or 560565DC)



Stand Mounted Assembly
(562043U)



Robot Mounted Assembly
(5601800U)



All items shown sold separately.

Dual Cartridge Dispense System

The dual cartridge dispense system (DCD) is an excellent, cost-effective solution for low-volume mixing and dispensing of two component materials supplied in dual cartridges. The fully portable bench-mounted system is simple to set up and program for accurate two-component dispensing.

DCD systems include a pneumatically actuated piston dispenser which applies pressure to accurately dispense materials contained in a dual cartridge.

Models	
Item Number	Description
DP50-1	50 ml Cartridge System
DP200-1	200 ml Cartridge System
DP400-1	400 ml Cartridge System

Features

- Mounted on a robust bench support to allow for height and angle adjustment when dispensing
- Includes 710PT-U pinch valve for increased accuracy and drip-free dispensing of low viscosity materials
- Supplied foot pedal allows for hands-free operation



Specifications

Air Input	70 - 100 psi
Air Output	1 - 100 psi
Pressure Adjustments	Variable
Pneumatic Connections	1/4"
Weight (without foot pedal)	14.5 kg (32 lb)
Foot Pedal Weight	1.8 kg (4 lb)
DP50-1 Weight	0.7 kg (1.45 lb)
DP200-1 Weight	1.6 kg (3.52 lb)
DP400-1 Weight	2.2 kg (4.85 lb)
Machine Directive	2006/42/EC

DB815-SB Foot Dispenser

The DB815-SB foot dispenser is a basic air powered dispensing system. Floor stationed and foot actuated, fluid will be dispensed only when the foot pedal is pressed.

A three-way air valve is included along with a built-in air regulator. The suck-back control ensures that low viscosity liquids do not drip.

Suitable for dispensing all types of fluids.



Features

- Economical and simple to use
- Suitable for a wide range of applications
- Barrel suck-back control
- All pneumatic operation

Item Number	Description
DB815-SB	Foot Dispenser

Specifications

Cycle	Maintained by User
Foot Pedal	Air Valve in Unit
Air Input	70 - 100 psi
Air Output	1 - 100 psi
Dimensions (WxDxH)	114.3 x 215.9 x 136.7 mm (4.5 x 8.5 x 5.38")
Weight	1.72 kg (3.8 lb)

VPPE511-LF Vacuum Pick-Up System

This vacuum pick-up system is designed for delicate handling of small parts and components including miniature, surface mount, and chip scale packages. Features an air solenoid vacuum electrically activated by pressing a foot pedal.

Features

- Foot pedal controlled
- Adjustable suck-back control
- Vacuum pressure readout
- 560046LL-NH for use with VPPE511-LF



Specifications

Cycle	Foot Pedal Control
Air Input	20 - 100 psi
Vacuum	Vacuum Gauge Display
Size	139.7 x 177.8 x 66.8 mm (5.5 x 7 x 2.63")
Weight	1.14 kg (2.5 lb)

Models

Item Number	Description
VPPE511-LF	Electric Vacuum Pick-Up System
VPP803-LF	Non-Electrical Vacuum Pick-Up System

VPP803-LF Vacuum Pick-Up System

The VPP803-LF vacuum pick-up system is designed for delicate handling of small parts and components including miniature, surface mount, and chip scale packages. The VPP803-LF is a non-electrical unit that has a vacuum pencil with a small hole that creates a vacuum.



Specifications

Cycle	Continuous
Air Input	20 - 100 psi
Vacuum	Up to 16 in hg
Size	95.3 x 177.8 x 66.8 mm (3.75 x 7 x 2.63")
Weight	0.34 kg (0.75 lb)



Features

- Adjustable vacuum control
- Manually actuated
- All pneumatic operation
- 560046LL for use with VPP803-LF

Vacuum Pick-Up Systems Accessories

Item Number	Description
560047	Vacuum Pad 0.140" (3.5 mm)
560048	Vacuum Pad 0.200" (5.1 mm)
560049	Vacuum Pad 0.250" (6.4 mm)
560050	Vacuum Pad 0.320" (8.1 mm)
560051	Vacuum Pad 0.400" (10.2 mm)
560052LL	Vacuum Tip #14 0.063" (1.6 mm)
560053LL	Vacuum Tip #18 0.033" (0.84 mm)
560054LL	Vacuum Tip #21 0.020" (0.51 mm)
560046LL	Vacuum Pick Up Pencil
560046LL-NH	Vacuum Pick Up Pencil (no hole)

700PTPCW Pinch Tube Pen

Pinch tube pens are ideal applicators for manually dispensing continuous beads or applying microdots of low viscosity liquids such as solvents and cyanoacrylates.

The disposable pinch tube is the only part of the pen that is in contact with the material and discarded when contaminated. The pinch tube pen can be connected via a wide range of interchangeable fittings to gravity fed or pressurized reservoirs.

Replacement Parts & Accessories

Item Number	Description	Included with 700PTPCW
5601390	Luer Lock Adapter - White	Yes
580045A	Pinch Tube (I.D. 0.10" x 4.10" long) - Clear	Yes
580047A-07-24	Fluid Line PE (I.D. 0.07" x 24" long) - Clear	No
580047A-10-18	Fluid Line PE (I.D. 0.10" x 18" long) - Clear	No
580047A-10-24	Fluid Line PE (I.D. 0.10" x 24" long) - Clear	Yes
580047A-10-36	Fluid Line PE (I.D. 0.10" x 36" long) - Clear	No
580045A-BLK	Pinch Tube (I.D. 0.10" x 4.10" long) - Black	No
580047A-BLK-07-24	Fluid Line PE (I.D. 0.07" x 24" long) - Black	No
580047A-BLK-10-24	Fluid Line PE (I.D. 0.10" x 24" long) - Black	No
580047A-BLK-10-36	Fluid Line PE (I.D. 0.10" x 36" long) - Black	No



IJ2601N-SS-SP reservoir sold separately.

560666 Gravity-Fed Bottle

500 ml gravity-fed bottle for use with low-viscosity fluids for dispensing small amounts of material.

Replacement Parts

Item Number	Description
560666	500 ml Bottle with Luer Lock Cap
560670U	Gravity Feed Bottle Stand
580047A	Fluid Line PE
700PTPCW	Pinch Tube Pen



Stand, pinch tube pen, fluid lines, and needle sold separately.

Dispensing Valves





Dispensing Valve Selection Guide

A wide selection of valves available for different fluid types and applications. This chart is designed for quick identification of recommended valves based on material chemistry and by matching the fluid type (vertical) to the application (horizontal).

Materials	Dots	Micro Dots	Beads/Lines	Potting/Filling	Spray
Acid/Solvent	VD510-SS, 710PT-U	VD510-SS, MV-0180SS	VD510-SS, 710PT-U	VD510-SS, 790HPSS-LF	SV1000SS
Anaerobic	VD510, 710PT-U	VD510, 710PT-U	VD510, 710PT-U	VD510, 710PT-U	-
Cyanoacrylate	VD510, 710PT-U	VD510	VD510, 710PT-U	VD510, 710PT-U	-
1-Part Epoxy	VP300, 790HP-LF, PDV-1000, VMS400	PDV-1000	VP300, 790HP-LF, PDV-1000, VMS400	VP300, 790HP-LF, VMS400	-
2-Part Epoxy	710PT-U	-	710PT-U	710PT-U	-
Grease/Gel	790HP-LF, VMS400	MV-0180LF	790HP-LF, VMS400	790HP-LF	-
Ink/Paint	VD510, VMP30H	MV-0180LF	VD510, VMP30H	VP300	SV2000N, SV1000SS
Liquid Flux	VD510, 710PT-U	MV-0180SS	VD510, 710PT-U	VMS400	SV2000N, SV1000SS
Lubricant/Oil	VD510	MV-0180LF	VD510, MV-0180LF	VP300, 790HP-LF	SV2000N, SV1000SS
Paste	VP300, 790HP-LF, PDV-1000	PDV-1000	VP300, 790HP-LF, PDV-1000	VP300, 790HP-LF	-
Reagent	VD510, MV-0180SS	VD510, MV-0180SS	VD510, MV-0180SS	VD510, 790HP-LF	-
RTV/Sealant	VP300, 790HP-LF	VMS400	VP300, 790HP-LF	VP300, 790HP-LF	-
Solder Mask	CV629, VMS400	MV-0180LF	CV629, VMS400	CV629, VP300	-
Solder Paste	PDV-1000	PDV-1000	PDV-1000	-	-
UV Adhesive	VD510-UV	VD510-UV, MV-0180SS	VD510-UV, VMS400	VD510-UV, 790HPSS-LF	SV2000N, SV1000SS

Valve & Controller Compatibility Chart

Valves	Controllers					
	DC200	VC1195N	SVC100	RVC900N	PC200	PZ-CON
790HP-LF	•	•				
790HPSS-LF	•	•				
VD510	•					
VD510-UV	•					
VD510-SS	•					
MV-0180LF	•	•				
MV-0180SS	•	•				
CV629	•					
SV2000N			•			
SV1000SS			•			
710PT-U	•					
PDV-1000				•		
VMS400	•	•				
VMP30H	•	•				
VP300	•	•				
VDP150		•				
PosiPump™ I-Series					•	
PosiPump™ V-Series					•	
Pz1200 Series						•

710PT-U Pinch Tube Valve

Engineered for precise control of low to medium viscosity liquids. The easy-to-use stroke control adjustment knob ensures accurate and repeatable dispense volumes.

The disposable pinch tube design allows for quick and easy servicing of the valve. Piston on/off actuation causes the pinch tube to open or close allowing material to flow through the valve.

The shot size or flow rate is determined by the degree of adjustment in releasing the closed (pinched) tube and by the valve control timer.

Features

- Disposable pinch tube and fluid lines
- Suitable for low to medium viscosity fluids
- Ideal for long pot life two component adhesives and cyanoacrylates
- Easy to use and maintain

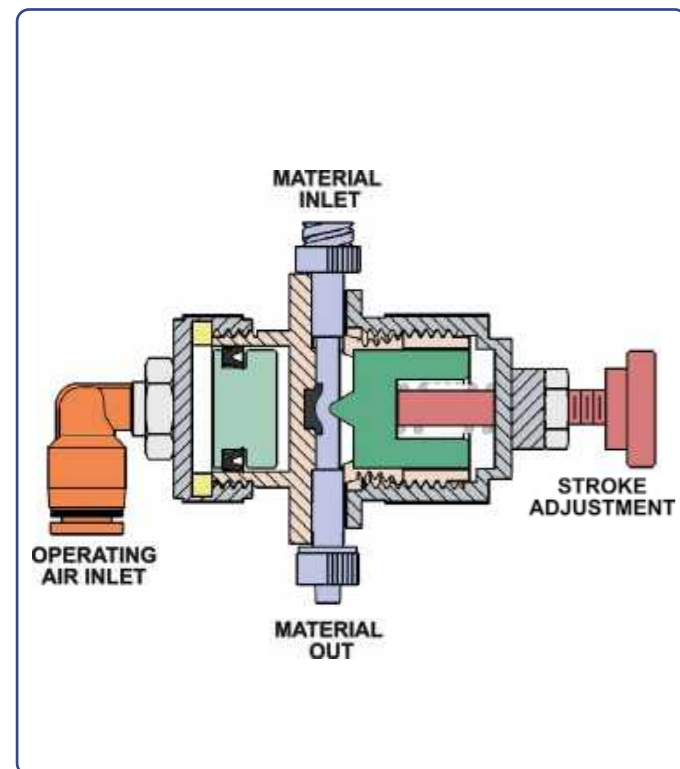

Item Number	Description
710PT-U	Pinch Tube Valve

Specifications

Operating Air Pressure	60 - 75 psi
Material Delivery Pressure	100 psi max
Valve Construction	
Valve Body	Nylon
Valve Shut-Off Piston	Acetal
Valve Piston	Aluminum
Valve Cylinder Cap	Aluminum
Valve Flange Cap	Aluminum
Valve Stroke Adjustment Knob	Coated Steel
Valve Seals	NBR
Wetted Part Materials	Polyethylene
Connecting Ports	
Operating Air	1/4" Push Connector
Material Inlet	Luer Lock
Material Outlet	Luer Lock
Mounting Hole Detail	1/4"-28 UNC
Weight	114 g (0.25 lb)

Accessories (Sold Separately)	
Item Number	Description
562054U	Valve Stand
710PTU-RK	Valve Repair Kit

*710PT-U valves come with rod for mounting.

710PT-U Pinch Tube Assembly

1. Remove flange, spring, and shutoff piston
2. Insert male end of dispense tube through side hole of valve body
3. Tilt the molded male end enough to pass by the push rod
4. Push dispense tube into place as shown, making sure shoulders are snapped into grooves
5. Insert shut off piston, spring, and threaded flange completely into valve body, making sure dispense tube is securely locked into grooves of body

710PT-U Pinch Tube Valve

Accessories	
Item Number	Description
580038A	Pinch Tube Assembly (I.D. 0.07" (1.778 mm))
580037A	Pinch Tube Assembly (I.D. 0.10" (2.54 mm))
580047A-07-24	Fluid Line PE (I.D. 0.07" x 24" long (1.778 x 609.6 mm)) - Clear
580047A-10-18	Fluid Line PE (I.D. 0.10" x 18" long (2.54 x 457.2 mm)) - Clear
580047A-10-24	Fluid Line PE (I.D. 0.10" x 24" long (2.54 x 609.6 mm)) - Clear
580047A-10-36	Fluid Line PE (I.D. 0.10" x 36" long (2.54 x 914.4 mm)) - Clear
580047A-BLK-07-24	Fluid Line PE (I.D. 0.07" x 24" long (1.778 x 609.6 mm)) - Black
580047A-BLK-10-24	Fluid Line PE (I.D. 0.10" x 24" long (2.54 x 609.6 mm)) - Black
580047A-BLK-10-36	Fluid Line PE (I.D. 0.10" x 36" long (2.54 x 914.4 mm)) - Black

VD510 Diaphragm Valve

The VD510 is a diaphragm valve designed for precise flow control of low to medium viscosity materials.

The diaphragm separates the wetted parts from the moving parts, thus making the valve ideal for dispensing cyanoacrylates, anaerobics, reagents, paints, UV adhesives, and other volatile substances.

Features

- Stroke adjustment to fine tune shots
- Separated wetted parts
- Easily serviceable
- Suitable for anaerobic fluids
- Positive shut off design

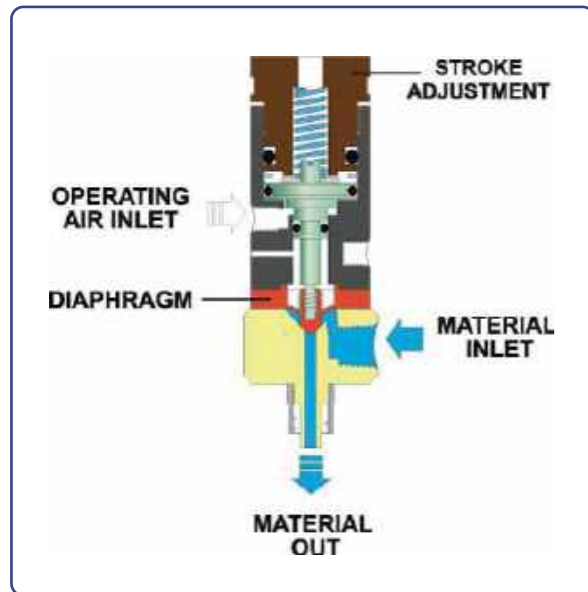

Accessories (sold separately)

Item Number	Description
VD510-RK	Valve Repair Kit
VD510SS-RK	Valve Repair Kit SS
VD510UV-RK	Valve Repair Kit UV
562043U	Valve Stand



Models

Item Number	Description
VD510	Diaphragm Valve
VD510-SS	Stainless Steel Diaphragm Valve
VD510-UV	UV Suitable Diaphragm Valve

Specifications

Operating Air Pressure	70 - 100 psi
Material Delivery Pressure	100 psi max
Flow Rate Maximum	0.3 L/min
Valve Construction	
Valve Body	Aluminum/SS
Valve Piston	SUS303
Valve Piston Seal	NBR
Wetted Part Materials	UHMWE-PE
Connecting Ports	
Air Input	M5 x 0.8
Material Inlet	1/8" NPT
Material Outlet	Luer Lock
Mounting Hole Detail	M5 x 0.8
Weight (VD510/UV)	69 g (0.15 lb)
Weight (VD510-SS)	121 g (0.27 lb)



MV-0180 Micro-Shot Needle Valve

Designed for precision dispensing of low viscosity fluids from micro shots to moderate-sized beads and dots. Its lightweight, pencil-type grip makes the valve suitable for either handheld or automated applications.

Shot size and flow rate are controlled by the tip size, fluid pressure, and the duration that the valve is open.



Models

Item Number	Description
MV-0180LF	Aluminum Needle Valve
MV-0180SS	Stainless Steel Needle Valve

Specifications

Operating Air Pressure	70 - 100 psi
Material Delivery Pressure	120 psi max
Valve Construction	
Valve Body	Aluminum/SS
Valve Piston	Aluminum
Valve Piston Seal	PTFE
Wetted Part Materials	Aluminum/SS
Connecting Ports	
Air Input	1/8" NPT
Material Inlet	1/8" NPT
Material Outlet	Luer Lock
Mounting Hole Detail	N/A
Weight (MV-0180LF)	173 g (0.38 lb)
Weight (MV-0180SS)	270 g (0.6 lb)

Accessories (sold separately)

Item Number	Description
MV0180LF-RK	Valve Repair Kit
MV0180SS-RK	Valve Repair Kit SS
560536U	Valve Stand

Features

- SS version available for volatile and corrosive materials
- Stroke adjustment to fine tune shot size
- Positive shut-off
- Micro-shot deposits

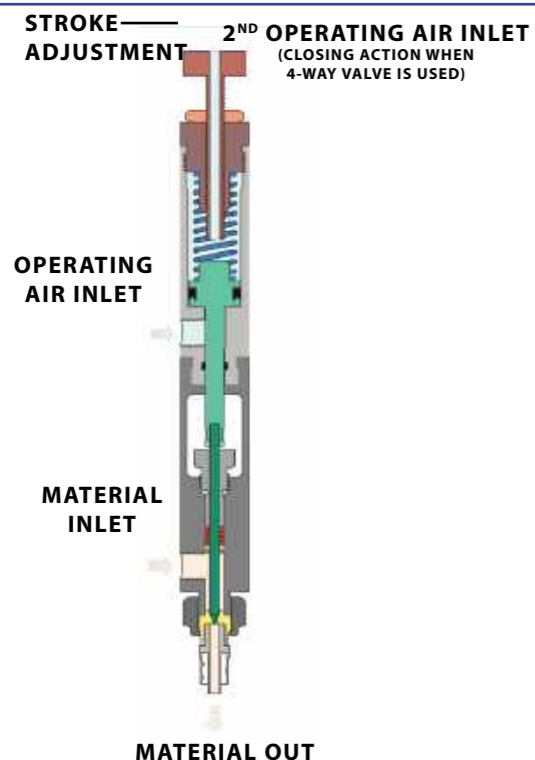

CV629 Cartridge Valve

The CV629 is a pneumatically-operated valve designed for precision dispensing of low to medium viscosity materials, such as solvents, oils, silicones, UV adhesives, inks, and more.

A simple design with accurate delivery.



Item Number	Description
CV629	Cartridge Valve

Specifications

Operating Air Pressure	70 - 100 psi
Material Delivery Pressure	300 psi max
Valve Construction	
Valve Body	Aluminum
Valve Needle	SS
Connecting Ports	
Operating Air Input	M5 thread with push-in fitting for O6 O.D. tube
Material Inlet	1/8" BSPP with push in fitting for O6 O.D. tube
Material Outlet	Luer Lock
Weight	135 g (0.3 lb)

Valve Stand (sold separately)

Item Number	Description
562166U	Valve Stand

Features

- Stroke adjustment to fine tune shot size
- Replaceable cartridge
- Micro-shot deposits
- High flow rate

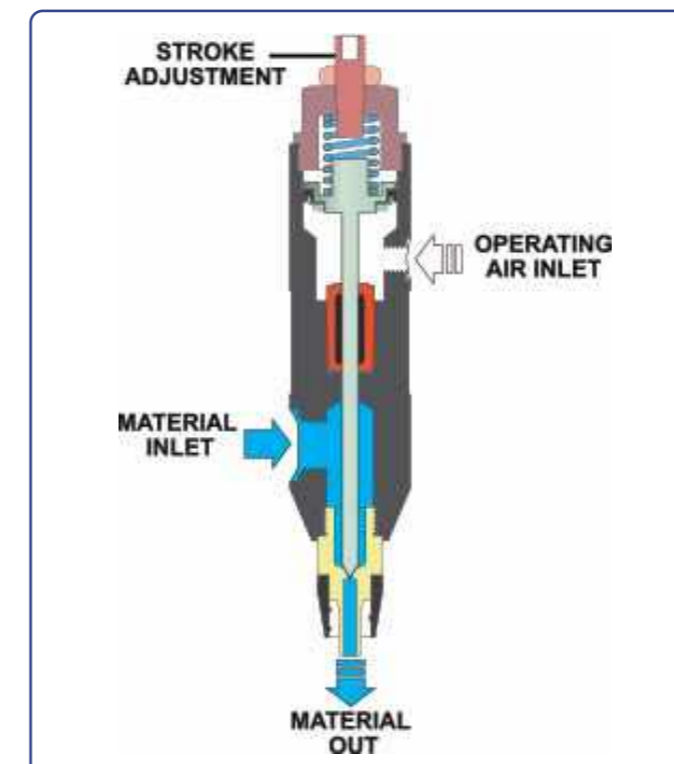

SV1000SS Stainless Steel Spray Valve

The SV1000SS spray valve provides close tolerance spray dispensing of fluids of up to 1000 cps. It is constructed of stainless steel to prevent corrosion from volatile materials. Designed specifically for spraying flux, paint, oils, lubricants, and coatings for use in coating and marking applications.

The flow rate is controlled by turning the stroke-adjust at the top of the valve in order to set the spray volume. Coating area and flow rate are controlled by the fluid pressure, needle stroke, distance from the valve to the component, and the duration the valve is open.

This spray valve is used in conjunction with the SVC100 controller.

Features

- Stroke-adjust control
- Tunable spray pattern
- Adjustable coating and flow rate

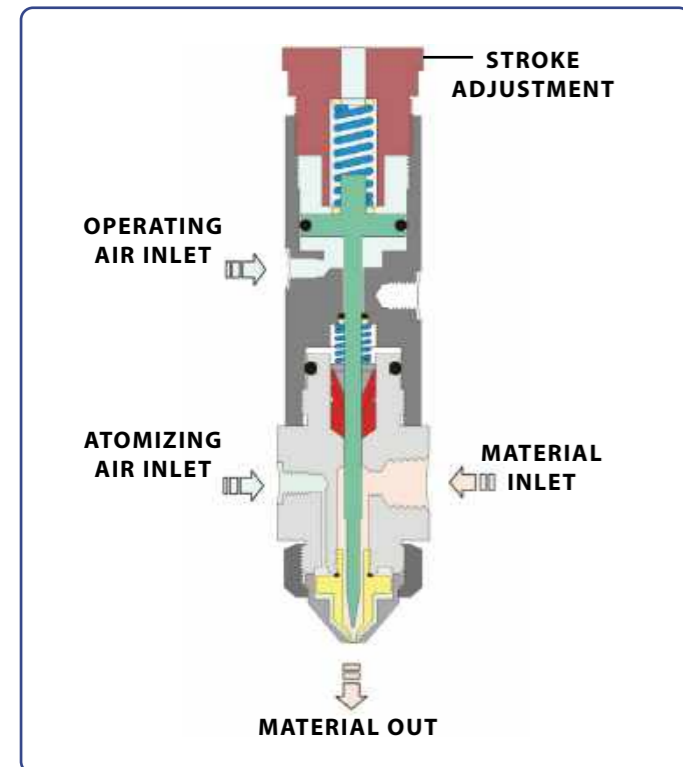

Item Number	Description
SV1000SS	Spray Valve

Specifications

Operating Air Pressure	70 - 100 psi
Atomizing Air Pressure	1 - 30 psi max
Fluid Viscosity Range	Up to 1,000 cps

Valve Construction

Valve Body/Piston	SS
Valve Seals	PTFE
Fluid Pressure	1 - 100 psi
Nozzle Diameter	0.028"

Operating Frequency	Up to 200 cycles/min
----------------------------	----------------------

Connecting Ports

Operating/Atomizing Air Inlet	10 - 32
Material Inlet	1/8" NPT
Weight	344 g (13.5 lb)

Accessories (sold separately)

Item Number	Description
SV1000SS-RK	Valve Repair Kit
562054U	Valve Stand

SV1000SS valve comes with rod for mounting.

SV2000N Adjustable Spray Valve

The SV2000N series are no-clog spray valves and work best with low-viscosity materials, typically less than 1000 cps. Material is typically fed to the spray valve from a pressure reservoir. Each valve is actuated by air pressure sequenced by a controller. The operating air pressure opens a needle valve allowing material to flow, while a separate airline creates pressure in the cap, atomizing the fluid.

Valve selection based on required spray area. Used in conjunction with the SVC100 controller.

Features

- Stroke-adjust control
- Tunable spray pattern
- Adjustable coating and flow rate

Accessories (sold separately)

Item Number	Description
SV2000N-RK	Valve Repair Kit
562054U	Valve Stand

SV2000N valve comes with rod for mounting.

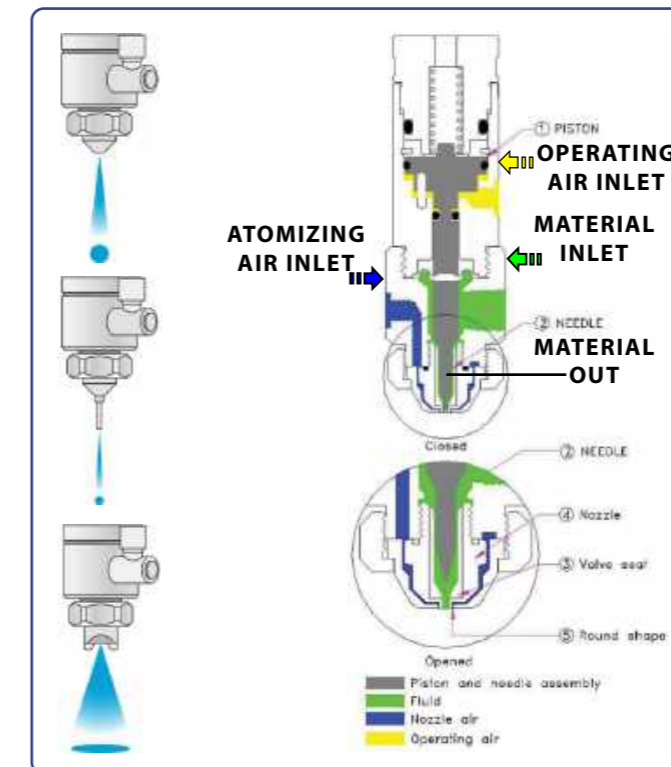

Models

Item Number	Description
SV2001N	Spray Valve Fine Dot & Bead
SV2002N	Spray Valve Medium Bead
SV2003N	Spray Valve Fan Pattern

Specifications

Operating Air Pressure	70 - 100 psi
Atomizing Air Pressure	1 - 30 psi max
Fluid Viscosity Range	Up to 1,000 cps

Valve Construction

Valve Body/Piston	SS
Valve Needle	SS
Valve Diaphragm	UHMW-PE
Valve Seat	PEEK

Fluid Pressure	1 - 100 psi
Operating Frequency	Up to 400 cycles/min

Spray Angle	SV2001N: 20° SV2002N: 30° SV2003N: 37°
--------------------	--

Connecting Ports

Operating/Atomizing Air Inlet	10 - 32
Material Inlet	1/8" NPT
Weight	236 g (0.5 lb)

VMP30H Mini Poppet Valve

The VMP30H is a pneumatic, mini poppet valve designed for dispensing small shots of medium viscosity materials. Its lightweight and compact design is beneficial for installation in confined work areas.

The poppet design minimizes surface area and friction between the valve piston and the material, making it ideal for filled materials and extending the life of the valve seals.

Features

- Suck-back effect to eliminate drooling at the end of the needle tip
- Suitable for filled materials
- Separated wetted parts
- Stroke adjustment feature for fine tuning shot size



Item Number	Description
VMP30H	Mini-Poppet Valve

Specifications

Operating Air Pressure	70 - 100 psi
Material Delivery Pressure	85 psi max
Flow Rate	MAX 1.2 L/min
Valve Construction	
Valve Body	Aluminum
Valve Piston	SUS303
Valve Piston Seal	NBR
Wetted Part Materials	
Chamber, Cap	SUS303
Diaphragm, Seal	UHMW-PE
O-ring	Viton®
Connecting Ports	
Air Input	M5 x 0.8
Material Inlet	1/8" NPT
Material Outlet	Luer Lock
Weight	162 g (0.36 lb)

Accessories (sold separately)

Item Number	Description
VMP30H-RK	Valve Repair Kit
562235U	Valve Stand

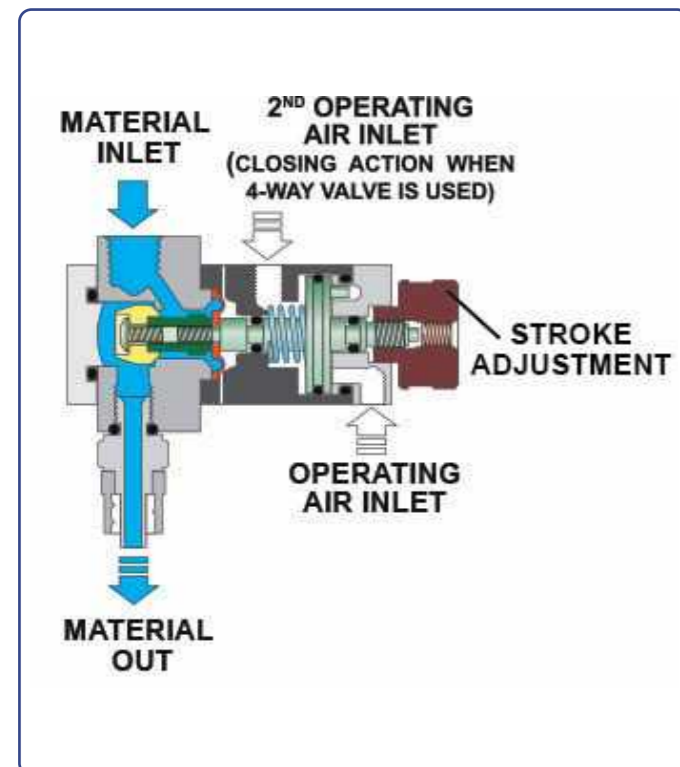

VP300 Poppet Valve

The VP300 is a multi-purpose, poppet-style, pneumatic valve designed for dispensing medium to high viscosity liquids such as silicone, epoxy, grease, solder paste, and other filled materials.

Its piston design maximizes fluid flow rate, while its sealing mechanism enhances valve durability.



Item Number	Description
VP300	Poppet Valve

Specifications

Operating Air Pressure	70 - 100 psi
Material Delivery Pressure	85 psi max
Valve Construction	
Valve Body	Aluminum
Valve Piston	SUS303
Valve Piston Seal	NBR
Wetted Part Materials	
Chamber, Cap	Aluminum
Diaphragm, Seal	UHMW-PE
O-ring	Viton®
Connecting Ports	
Air Inlet	M5 x 0.8
Material Inlet	1/8" NPT
Material Outlet	1/4" NPT
Mounting Hole	M5 x 0.8
Weight	180 g (0.4 lb)

Accessories (sold separately)

Item Number	Description
VP300-RK	Valve Repair Kit
562043U	Valve Stand

Features

- Suck-back effect to prevent drooling at the end of the needle tip
- Suitable for filled materials
- Separated wetted parts
- Stroke adjustment to fine tune shot size

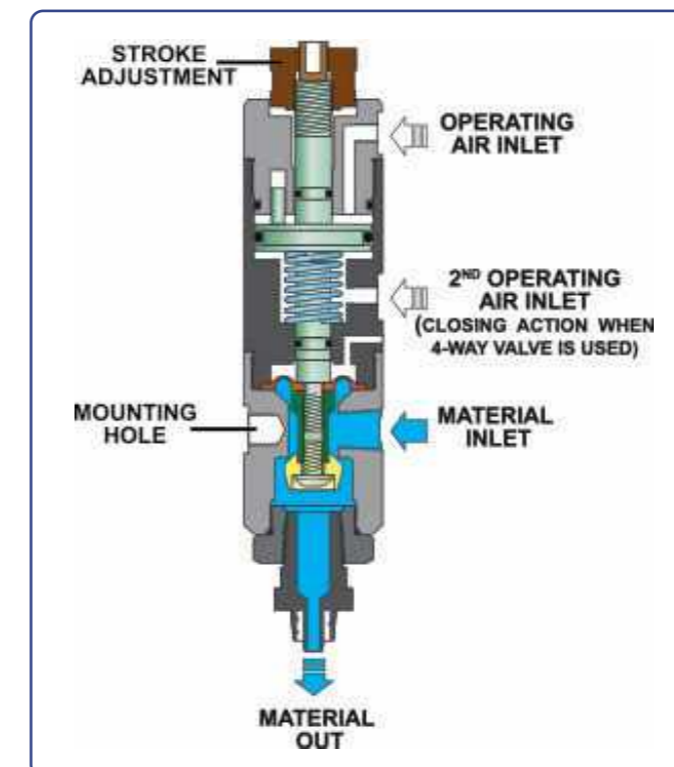

VMS400 Mini Spool Valve

The VMS400 is a mini spool valve designed for dispensing small volumes of medium to high viscosity materials. When air pressure is applied to the air inlet of the valve, the spool will be forced forward and fluid will be dispensed.

Shot size and flow rate are controlled by the tip size, fluid pressure, and the duration that the valve is open.



Features

- High-pressure fluid input up to 700psi
- Suitable for high viscosity fluids
- Adjustable suck-back
- Stainless steel wetted parts for volatile and corrosive materials

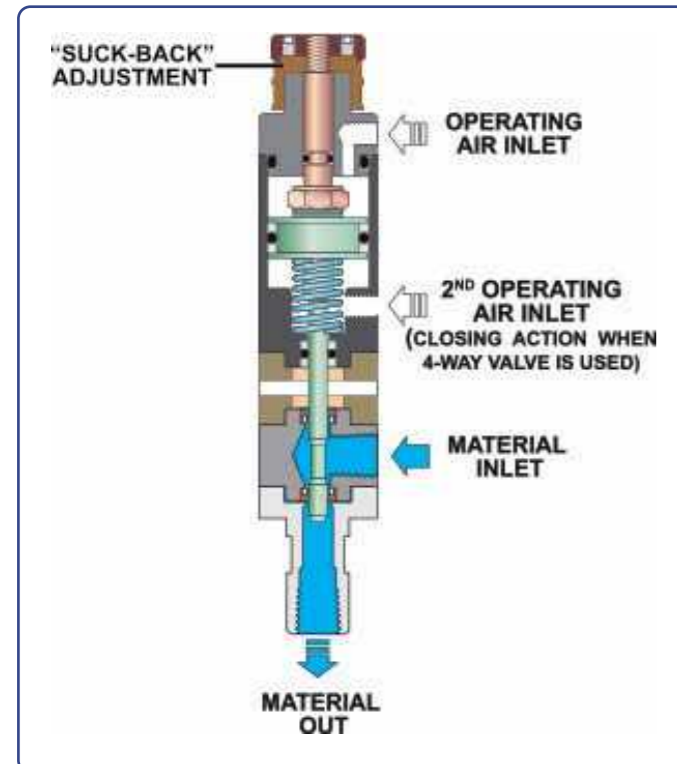

Item Number	Description
VMS400	Mini Spool Valve

Specifications

Operating Air Pressure	70 - 100 psi
Valve Construction	
Valve Body, Piston	SUS303
Valve Spool	SUS420
Valve Cap	Aluminum
Wetted Part Materials	
Valve Chamber, Cap	SUS303
Valve Seal	UHMW-PE Lip Seal
Connecting Ports	
Air Inlet	M5 x 0.8
Material Inlet	1/8" NPT
Material Outlet	Luer Lock
Weight	255 g (0.56 lb)

Accessories (sold separately)

Item Number	Description
VMS400-RK	Valve Repair Kit
562235U	Valve Stand

790HP-LF High-Pressure Valve

The 790HP-LF high-pressure spool valve offers an effective solution for dispensing high viscosity materials such as silicones, sealants, and greases.

A spring snap-back retraction closes the valve resulting in a suck-back at the fluid outlet to prevent dripping.



Models

Item Number	Description
790HP-LF	Aluminum High Pressure Valve
790HPSS-LF	Stainless Steel High Pressure Valve

Features

- High-pressure fluid input up to 2,500 psi
- Suitable for high-viscosity fluids
- SS version available for volatile and corrosive materials
- Easy to clean and maintain
- Extra pneumatic air-port for use with 4-way valve controller for rapid valve closure

Specifications

Operating Air Pressure	70 - 100 psi
Material Input Pressure	2,500 psi max
Valve Construction	
Valve Body	Aluminum/SS
Valve Piston	Aluminum
Valve Spool	SS (TiCN coated)
Valve Seals	UHMW PE
Valve O-ring	Viton®
Connecting Ports	
Air Input	1/4" NPT
Material Inlet	1/4" NPT
Material Outlet	1/4" NPT
Weight (790HP-LF)	524 g (1.16 lb)
Weight (790HP-SS)	744 g (1.64 lb)

Accessories (sold separately)

Item Number	Description
790HP-RK	Valve Repair Kit
790HP-RKS	Valve Repair Kit SS
560671U	Valve Stand

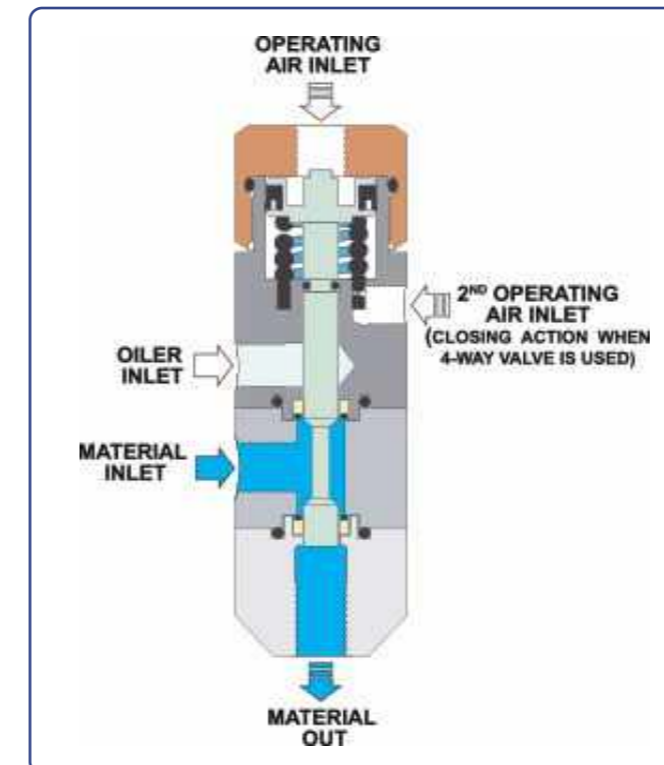

VDP150 Positive Displacement Valve

The VDP150 is a pneumatically-operated positive displacement valve designed for dispensing constant volume shots up to 0.15 cc of low to medium viscosity materials.

Featuring two integral check valves to control the flow of material, the valve is cycled by applying air pressure to the air ports. No fluid pressure is required for low-viscosity materials (less than 5,000 cps) as the material is drawn into the displacement chamber by the plunger.

Features

- Positive displacement metering
- Integral inlet/outlet check valves
- Stroke adjustment to fine tune shot size

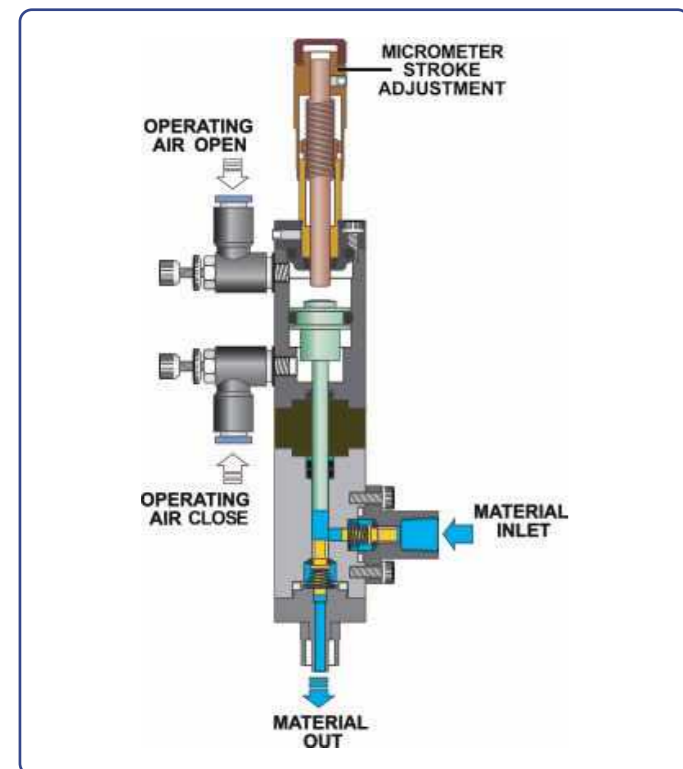

Item Number	Description
VDP150	Positive Displacement Valve

Specifications

Operating Air Pressure	70 - 100 psi
Maximum Shot Size	0.15 cc/cycle

Valve Construction

Valve Cylinder Body	Aluminum
Valve Piston	SUS303
Valve Check Body	SUS303, RULON

Wetted Part Materials

Valve Chamber, Cap & CV Body	SUS303
Valve Plunger	SUS420 (tin coating)
Check Valve	PEEK
Check Valve O-rings	FFKM

Connecting Ports

Air Input	M5X0.8
Material Inlet	1/8" NPT
Material Outlet	Luer Lock
Weight	323 g (0.7 lb)

Accessories (sold separately)

Item Number	Description
VDP150-RK	Valve Repair Kit
562235U	Valve Stand

PDV-1000 Auger Valve

The PDV-1000 precision auger valve is suitable for medium to high viscosity epoxy, solder paste, and other filled materials. Capable of dispensing micro shots less than 1mm using an auger servo motor driven screw.

The PDV-1000 has zero dead space within the valve and can deliver accurate and repeatable dots and beads for any application, whether automated or manually operated.

This auger valve is used in conjunction with the RVC900N controller.

Comes standard with 3, 5, and 10 cc bushings.



Features

- Ideal for heavily filled and abrasive materials
- Micro-shots less than 1 mm
- Flexible coupling from motor to screw
- No dead space – high repeatability
- Disposable fluid feed tube

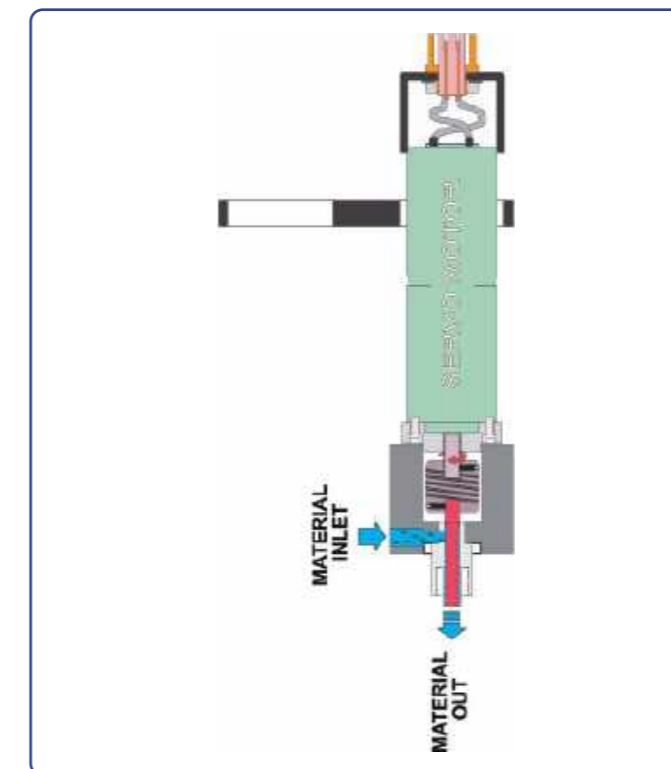

Models

Item Number	Description
PDV-1000-8P	8 Pitch Auger Valve (3,5,10,30/55 cc)
PDV-1000-16P	16 Pitch Auger Valve (3,5,10,30/55 cc)
PDV-1000-32P	32 Pitch Auger Valve (3,5,10,30/55 cc)

Specifications

Motor Voltage	24 VAC
Motor	6 watt, 400rpm (no load)
Valve Construction	SS
Valve Body	Aluminum
Valve Auger	SS
Valve Syringe Bracket	Aluminum
Minimum Material Viscosity	35,000 cps
Weight	212 g (0.5 lb)

Accessories (sold separately)

Item Number	Description
561446B	Elbow Replacement Tube Assembly
562235U	Valve Stand

PosiPump™ I-Series Progressive Cavity Valve

The PosiPump™ I-Series Progressive Cavity Valve offers true volumetric dispensing in order to achieve exceptional levels of repeatability.

A proven endless piston design principle ensures a constant volume is always dispensed, regardless of any changes in fluid viscosity, thixotropy, or fluid inlet pressure.

Bi-rotational control ensures a drip free dispense cycle thanks to an infinitely adjustable suckback.

Features

- Dispense volume as small as 0.008 ml per revolution
- Constant volumetric & pressure-stable dispense system
- Dispense volume is not affected by changes in fluid viscosity or feed pressure
- FKM or FFKM Stator Material
- Long service life

Section View

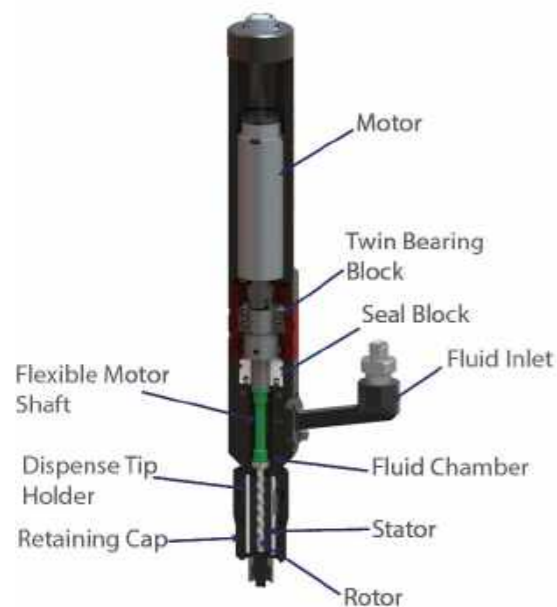

Connecting cable required for operation. Sold separately. See page 73.



Models

Item Number	Description
PC-I8	Progressive Cavity Valve - 0.008 cc
PC-I50	Progressive Cavity Valve - 0.05 cc
PC-I500	Progressive Cavity Valve - 0.5 cc

Benefits

- No dripping/drooling after dispense cycle
- Suitable for both low & high viscosity fluids
- Pressurization of fluid feed system is not necessary for self-leveling low viscosity fluids
- Prevents damage to fillers in filled fluid materials
- High level of process control

Endless Piston Principle

The Fisnar PosiPump™ valve is based on the endless piston principle using a rotor and stator to create a self-sealing pressure-tight positive displacement system.



PC-I8

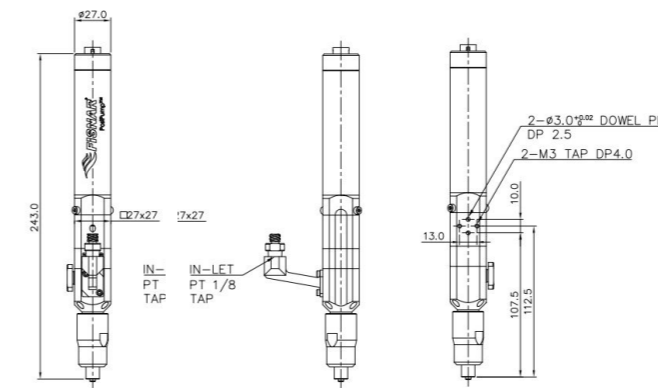

PC-I50/PCI500

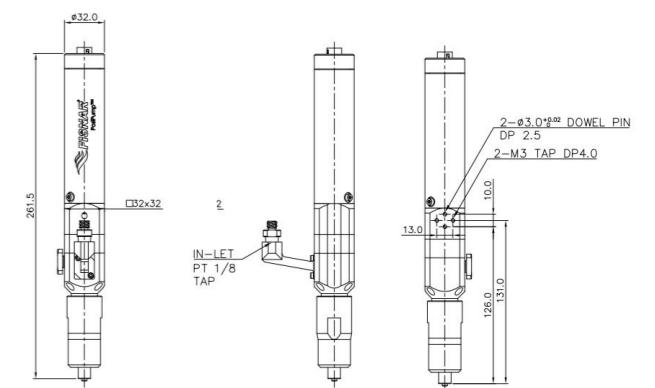

Specifications

Item Number	PC-I8	PC-I50	PC-I500
Dosing Volume/Rev	0.008 ml	0.05 ml	0.5 ml
Motor Speed	1 - 120rpm	1 - 120rpm	1 - 120rpm
Max Flow Rate	0.96 ml/min	6 ml/min	60 ml/min
Fluid Input Pressure	1 - 100 psi	1 - 100 psi	1 - 100 psi
Rotor Material	SUS316	SUS316	SUS316
Stator Material Size	FKM (FFKM option)	FKM (FFKM option)	FKM (FFKM option)
Fluid Inlet & Outlet Material	AL6061 Hard Anodize	AL6061 Hard Anodize	AL6061 Hard Anodize
Seal Material	UHMW-PE	UHMW-PE	UHMW-PE
O-Ring Material	Viton®	Viton®	Viton®
Fluid Inlet Thread	1/8" BSP / Luer Lock	1/8" BSP / Luer Lock	1/8" BSP / Luer Lock
Fluid Outlet Thread	Luer Lock	Luer Lock	Luer Lock
Weight	380 g (0.8 lb)	540 g (1.2 lb)	540 g (1.2 lb)

PosiPump™ Accessories

Cable Assemblies

Valve connecting cable ensures the correct signal communication between the PosiPump™ valves and PC200 valve controller.

An optional fluid pressure sensor system can be installed on the PosiPump™ V-Series valve to monitor the fluid pressure, preventing potential motor failure due to curing of two component material inside the mixing nozzle.



Item Number	Description	PC-18	PC-150	PC-1500	PC-V16	PC-V100	PC-V550	PC-V1000
5601912	Valve Conn. Cable 10 ft (3 m)	•	•	•	•	•	•	•
5601913	Valve Conn. Cable 30 ft (9.1 m)	•	•	•	•	•	•	•
5601914	Fluid Pressure Sensor Kit 10 ft (3 m)				•	•	•	•

Auxillary Equipment

A range of brackets and supports to assist in the safe and secure mounting of the PosiPump™ valve as well as for mounting the syringe barrel or cartridge fluid feed system to the valve itself.



Item Number	Description	PC-18	PC-150	PC-1500	PC-V16	PC-V100	PC-V550	PC-V1000
5601920	Syringe Barrel Support 30/55 cc	•	•	•				
5601921	Syringe Barrel Support 30/55 cc				•	•	•	•
5601922	Cartridge Support 6/12 oz	•	•	•				
5601923	Cartridge Support				•	•	•	•
5601800U	Robot Mounting Bracket	•	•	•	•	•	•	•
562318U	Valve Stand	•	•	•	•	•	•	•

PosiPump™ Accessories

Mixer Manifolds

A variety of Mixer Manifolds for the PosiPump™ V-Series are offered, depending on the fluid mix ratio and mixing nozzle to be used.



Item Number	Description	PC-V16	PC-V100	PC-V550	PC-V1000
5601915	Mixer Manifold K 1:1 / 2:1	•			
5601916	Mixer Manifold K Wide Ratio	•			
5601917	Mixer Manifold B 1:1 / 2:1		•		•
5601918	Mixer Manifold B Wide Ratio		•	•	•
5601919	Mixer Manifold C		•	•	•

Mixer Series Compatibility

PosiPump™ V-Series progressive cavity valves are designed for use with a variety of different mixing nozzles, in order to fully optimize the mixing of the fluid based on the application specification.

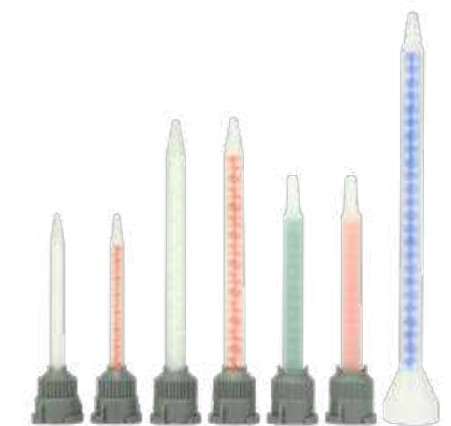

Mixer Manifold	PC-V16	PC-V100	PC-V550	PC-V1000
5601915	MKH			
5601916	MKHX			
5601917		MBH / MBQ		MBH / MBQ
5601918		MBHX / MBQX	MBHX / MBQX	MBHX / MBQX
5601919		ME	ME	

PosiPump™ Accessories

Service Parts

A selection of service parts are available for maintaining the dispense performance of the PosiPump™ progressive cavity valves.



Item Number	Description	PC-18	PC-150	PC-1500	PC-V16	PC-V100	PC-V550	PC-V1000
5601924	Cleaning Kit	•	•	•	•	•	•	•
5601925	0.008 cc Stator Assembly FKM	•			•			
5601926	0.008 cc Stator Assembly FFKM	•			•			
5601927	0.05 cc Assembly FKM		•			•	•	
5601928	0.05 cc Assembly FFKM		•			•	•	
5601929	0.5 cc Assembly FKM			•			•	•
5601930	0.5 cc Assembly FFKM			•			•	•
5601931	0.008 cc Rotor Assembly	•			•			
5601932	0.05 cc Rotor Assembly		•			•	•	
5601933	0.5 cc Rotor Assembly			•			•	•
5601934	I-Series Seal Kit 0.008 cc		•					
5601935	V-Series Seal Kit 0.008 cc				•			
5601936	I-Series Seal Kit 0.05 cc / 0.5 cc		•	•				
5601937	V-Series Seal Kit 0.05 cc / 0.5 cc					•	•	•
5601938	Stainless Steel Fluid Fitting 1/8" PT x 1/4" O.D. Tube	•	•	•	•	•	•	•
5601939	Stainless Steel Fluid Fitting 1/8" PT x Female Luer Lock	•	•	•	•	•	•	•



Pz1200 Piezo Electric Jet/Contact Dispense Valve

The Pz1200 Piezo Electric Valve can be configured as a non-contact jet or precise high-speed contact dispensing valve. The advanced piezo-electric ceramic actuation technology achieves exceptional levels of dispense accuracy and superior process control.

The inclusion of an integrated closed loop heater element inside the valve allows the fluid viscosity to be stabilized, to assist in optimizing jet ability and dispense process control.

The unique modular valve design gives complete versatility, in order for it to be correctly configured for both application process and dispense fluid requirements.



Valve seat module & fluid inlet fitting required for operation. Sold separately.

Item Number	Description
PZ1200S	Piezo Valve - Medium Viscosity
PZ1200D	Piezo Valve - High Viscosity

Benefits

- When used as a jet valve, Z-axis movement in between cycles is eliminated, which results in increased production cycle speeds
- Reduced production downtime due to faster maintenance times
- Ideal for use on uneven substrates or hard to access areas
- Compatible with a range of low to high viscosity fluids
- Modular design allows wetted parts to be easily serviced

Features

- Dot size as small as 1 nl/0.2 mm
- Exceptional dispense accuracy
- Fixed valve stroke ensures superior process control
- Continuous cycle rates up to 1,200 Hz
- Fast cycle times and long service life
- Durable ceramic cartridge ball and valve seat
- Closed loop fluid heater for stabilizing fluid viscosity

Piezo Technology Valve Operation

The piezo actuator is composed of two stacks of ceramic disks that change shape as voltage is applied. This creates a deflection in the cantilever arm, causing the actuator stem to lift at a fixed stroke.

When the ceramic ball lifts off its ceramic seat, the resulting cavity fills with fluid. As the ball reseats, a fluid droplet ejects from the valve.

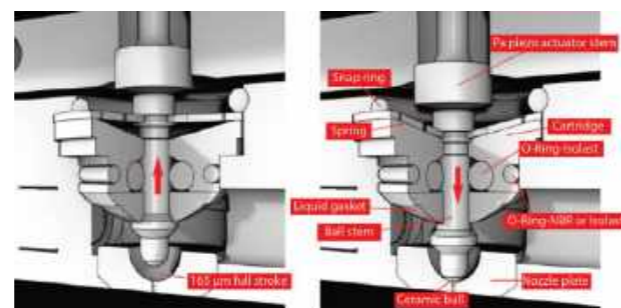
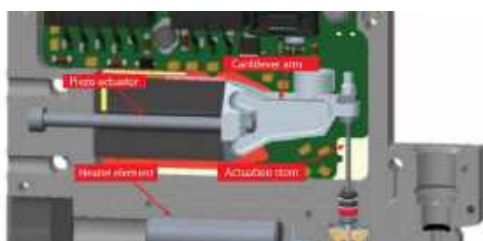

Pz1200S/Pz1200D

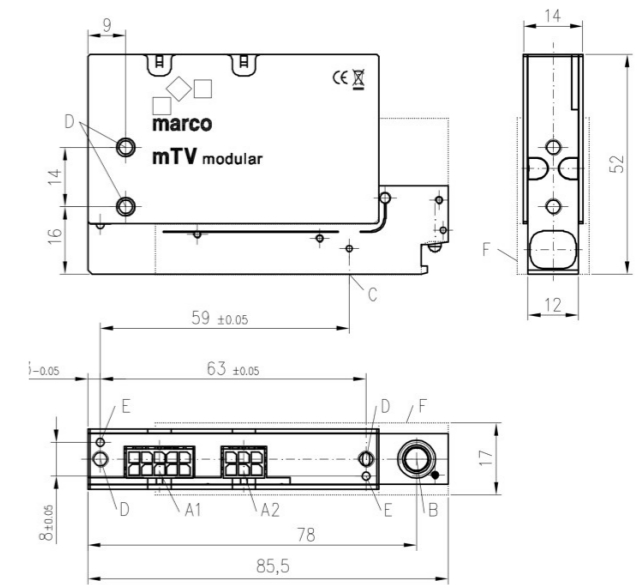
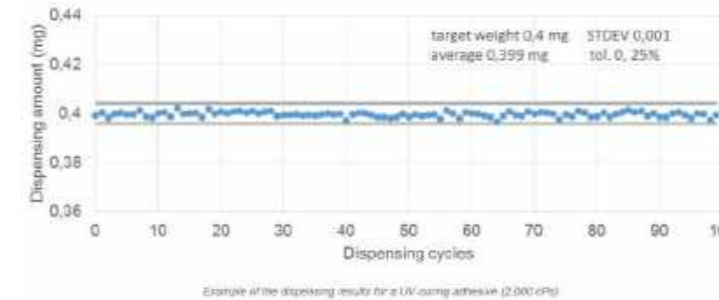

Specifications

Item Number	Pz1200S	Pz1200D
Material Delivery Pressure	1,000 psi max	1,000 psi max
Viscosity Range	1 - 100,000 cps	50,000 cps
Wetted Components	Stainless Steel 303, Ceramix FFKM, NBR, PEEK	Stainless Steel 303, Ceramix FFKM, NBR, PEEK
Material Inlet	M8x1	M8x1
Min. Dispensing Time	0.20ms	0.18ms
Max Continuous Dispensing Frequency	1200 Hz	500 Hz
Max Burst Dispensing Frequency	2,000 Hz	750 Hz
Maintenance/Inspection Interval	Approx. 10,000,000 cycles (fluid dependant)	Approx. 10,000,000 cycles (fluid dependant)
Dispensing Accuracy	>99% (non-varying conditions)	>99% (non-varying conditions)
Max Fluid Input Pressure	Up to 75 bar	Up to 75 bar
Max Fluid Temperature	Up to 75 °C	Up to 75 °C
Weight	320 g (0.7 lb)	320 g (0.7 lb)
Dimensions (WxDxH)	86 x 17 x 52 mm (3.4 x 0.7 x 2")	86 x 17 x 52 mm (3.4 x 0.7 x 2")

Pz1200 Accessories

Valve Seat Modules

A range of jet valve seats and contact dispense modules (including cartridge) are available dependent on the specific application requirement and fluid material being processed.

Jet valve seat modules are available in two different fluid outlet chamber designs to optimize fluid jetting performance.

C-Type: Standard choice for most low-medium viscosity fluids
T-Type: Suited for high viscosity/stringy fluids (other valve seat / cartridge modules are also available)

Consult with your local Fisnar sales representative for the best configuration based on your specific application.



Item Number	Description	Nozzle Size	Valve Seat Type	Cartridge Type/Size
PZ-VS-D100C	Valve Seat	100 µm	Non-Contact (Jetting)	C / 1.58 mm
PZ-VS-D100T	Valve Seat	100 µm	Non-Contact (Jetting)	T / 1.58 mm
PZ-VS-D150C	Valve Seat	150 µm	Non-Contact (Jetting)	C / 1.58 mm
PZ-VS-D150T	Valve Seat	150 µm	Non-Contact (Jetting)	T / 1.58 mm
PZ-VS-D300C	Valve Seat	300 µm	Non-Contact (Jetting)	C / 1.58 mm
PZ-VS-D300T	Valve Seat	300 µm	Non-Contact (Jetting)	T / 1.58 mm
PZ-VS-SN*	Valve Seat	800 µm	Contact Needle Dispensing	C / 1.58 mm
PZ-VS-LL*	Valve Seat	600 µm	Contact Needle Dispensing	C / 1.58 mm

*For contact dispensing, we recommend the PZ-VS-SN screw nozzle valve seat, due to its superior dispense performance in eliminating fluid drool post dispense, while also maintaining a constant Z-height position during the changing of dispense nozzles.

Screw Nozzles

A range of screw nozzles suitable for use on PZ-VS-SN valve.

Item Number	Description
PZ-TIP-SN100	Screw Nozzle 100 µm
PZ-TIP-SN200	Screw Nozzle 200 µm
PZ-TIP-SN300	Screw Nozzle 300 µm
PZ-TIP-CAP	Screw Nozzle Protection Cap



Pz1200 Accessories

Fluid Inlet Fittings & Accessories

Available in two different types based on whether fluid is being fed directly from a syringe barrel or remotely via tubing from a fluid reservoir.

Item Number	Description
PZ-INLET-LLH	Fluid Inlet Fitting – Luer Lock
PZ-INLET-HOSE4H	Fluid Inlet Fitting – 4 mm I.D. Tubing
PZ-INLET-SUPPORT	30/55 cc Syringe Barrel Support Bracket



Service Parts

A selection of service parts to assist in maintaining the valve seat module during cleaning and preventative maintenance.

Item Number	Description
PZ-CART-D	Cartridge - 1.58 mm
PZ-SPARE-1	Snap Ring for Valve Seat (10 Pack)
PZ-SPARE-2	O-Ring for Valve Seat (10 Pack)
PZ-SPARE-3	Grub Screw for Valve Seat (10 Pack)



Service Tools & Cleaning

Specifically designed hand tools are available to aid assembly/disassembly of valve seat modules.

A useful cleaning kit containing a variety of cleaning utensils perfectly suited for cleaning the valve seat module and fluid inlet fitting.

Item Number	Description
PZ-TOOL-1	Screw Nozzle Removal/Insertion Tool
PZ-TOOL-2	Snap Ring Removal/Insertion Tool
PZ-TOOL-3	Cartridge Removal/Insertion Tool
PZ-TOOL-4	Valve Seat Removal Tool
PZ-CLEAN-KIT	Pz1200 Cleaning Kit



Syringe/Cartridge Retainer Stands



560021U
Syringe Barrel
Stand



560549U
CR300 Cartridge
Retainer Stand



560535-NU
Nylon Retainer Stand
2.5, 6, 8 & 12 oz



560671U
790HP-LF
Valve Stand



562044U
PPD-130
Valve Stand



560536U
MV-0180
Valve Stand



560535-TU
Metal Retainer Stand
2.5, 6, 8 & 12 oz



560534U
CR570 & 101-20R 20 oz
Retainer Stand



562166U
CV629 Valve Stand



562043U
VD510, VP300 Valve Stand,
DTD50 & DTD50-RB



562054U
SV1000SS*, SV2000N*,
710PT-U* Valve Stand



560670U
Gravity-Fed 500 ml
560666 Bottle Stand



562235U
VMP30H, PDV-1000, VMS400,
VDP150 Valve Stand

**Rod included with SV1000SS, SV2000, and 710PT-U valves.*

Valve Controllers



Fisnar valve controllers are used to ensure long lasting and reliable control of our complete range of precision dispense valves. They provide a simple and convenient way of accurately controlling and adjusting cycle times. The wide range of available valve controllers offered, allow them to be individually tailored to their specific compatible valve type to ensure efficient and optimal performance.

DC200 Precision Valve Controller

A multi-purpose digital controller, recommended for use with Fisnar pneumatically-actuated valves. This system uses a high-performance regulator with constant pressure control and a digital display to provide consistent, repeatable control.

For use with 710PT-U, VD510, MV-0180, CV629, VP300, VMP30H, 790HP, and VMS400 dispense valves.



Push-to-connect style fitting standard on DC200 controller.

560671U Stand and 790HP-LF Valve sold separately.

Features

- Air input tolerance can be set for consistent pressure
- Can be locked to keep programs from being modified
- Auto purge and glue alarm to prevent premature curing of materials
- Dispense counter for tracking completed dispense cycles
- Multiple dispensing modes for easy use in many applications
- I/O circuit for external control and robot integration
- Regulator sensitivity of 0.2% and a repeatability of +/-0.5%

Item Number	Description
DC200	Digital Valve Controller

Specifications

Cycle Rate	600+ cycle/minute
Timer	0.008 - 9999s
Programs	10 memory slots
Input AC to Power Supply	100 - 240 VAC, 50/60 Hz
Output DC from Power Supply	24 VDC - 0.75 Amp
Air Input	70 - 100 psi max
Air Output	1 - 100 psi
Dimensions (WxDxH)	180 x 195 x 80 mm (7.09 x 7.68 x 3.15")
Weight	1 kg (2.2 lb)
Standards	CE Approved, RoHS compliant

VC1195N 4-Way Valve Controller

A 4-way valve controller that can be used to control one or two valves simultaneously. The high flow, high speed, internal solenoid rapidly shuts off the dispense valve to prevent drooling and ensures consistent dispense results, by providing a constant air supply to the dispense valve. This ensures it remains in a closed position to prevent premature actuation.

For use with 790HP, VDP150, VMS400, VMP30H, VP300, and MV-0180 dispense valves.



562235U stand and VDP150 Valve sold separately.

Features

- Timing interval from 0.01 to 31 seconds
- Fast response internal pneumatic solenoid
- Actuated by foot pedal or remotely from a robot
- Manual and timer modes
- Can simultaneously control up to two valves

Item Number	Description
VC1195N	4-Way Valve Controller

Specifications

Dispense Time	0.01 - 31s
Voltage	100 - 240 VAC, 50/60 Hz
Air Input	70 - 100 psi
Air Output	1 - 100 psi
Dimensions (WxDxH)	264.2 x 209.6 x 69.9 mm (10.4 x 8.25 x 2.75")
Weight	1.9 kg (4.2 lb)

SVC100 Spray Valve Controller

A fully integrated spray valve controller suitable for all Fisnar SV series spray valves. Simple setup and operation for a variety of basic and advanced spray applications.

The SVC100 spray valve controller allows the fluid dispense signal and atomizing air signal to be independently programmed to achieve a clean and precise spray pattern.



562054U stand and SV1000SS valve sold separately.

Features

- Timed or continuous spray
- Clean, clog-free cut off
- Easy integration with robotic platforms

SVC100 Setup

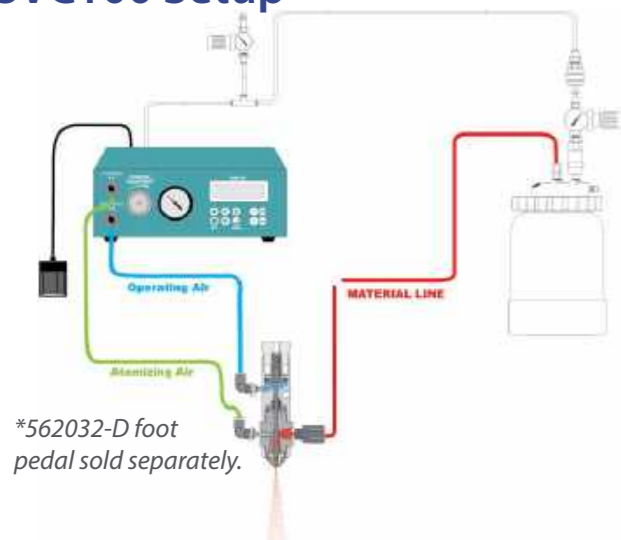

*562032-D foot pedal sold separately.

Models

Item Number	Description
SVC100-110	110 VAC Spray Valve Controller
SVC100-220	220 VAC Spray Valve Controller

Specifications

Dispense Time	0.008 - 99.99s
Voltage	SVC100-110: 110 VAC, 50/60 Hz SVC100-220: 220 VAC, 50/60 Hz
Air Input	70 - 100 psi
Valve Air Output	70 - 100 psi
Spray Air Output	1 - 60 psi
Dimensions (WxDxH)	232.7 x 187.5 x 82.6 mm (9.16 x 7.38 x 3.25")
Weight	2.72 kg (6 lb)

RVC900N Auger Valve Controller

The RVC900N controls the PDV-1000 series of auger valves. The controller delivers accurate and repeatable dots and beads for any application, whether automated or manually operated.

Due to the constant motor speed output, any change in material viscosity does not impact the dispense flow rate. The controller supplies material pressure to the barrel, adjusted via a regulator and pressure gauge. A reverse timer and speed control can set the amount of controlled suck-back at the end of the dispense cycle.

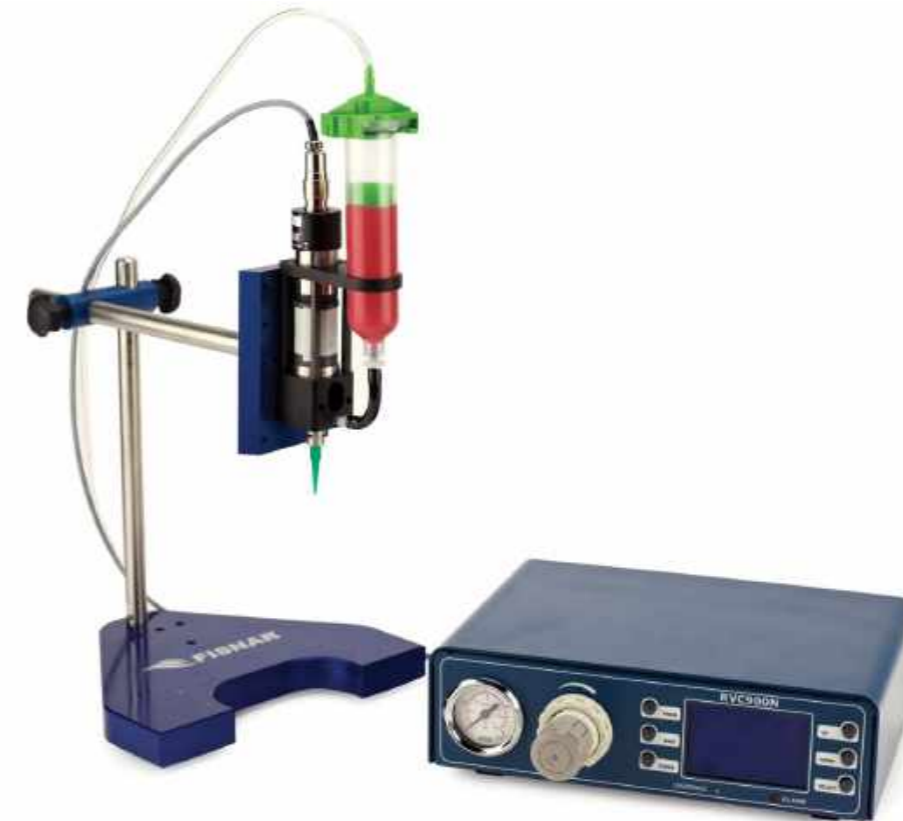

562235U stand and PDV-100 valve sold separately.

Features

- Simple to program
- Up to 8 stored programs
- Auto or manual control
- Constant motor speed
- Adjustable forward and reverse speed and time

Specifications

Item Number	Description
RVC900N	Auger Valve Controller
Time Range	0.01 - 99.99s
Voltage	100 - 240 VAC, 50/60 Hz
Output Pressure	1 - 60 psi
Dimensions (WxDxH)	230 x 210 x 70 mm (9.05 x 8.26 x 2.76")
Weight	1.65 kg (3.6 lb)

PC200 Progressive Cavity Valve Controller

An advanced valve controller suitable for use with all Fisnar PC I-Series and V-series progressive cavity valves.

The Graphic User Interface (GUI) provides simple touch-screen programming and operation for both one and two component dispense applications.

The 4" HMI display allows all dispense parameters to be independently programmed on one single screen. An integral pressure regulator and digital pressure gauge ensure easy system installation.

Features

- Manual and timed dispense modes
- Digital pressure output display
- Operator lockout
- Adjustable forward & reverse speed
- Controllable suck-back delay dwell time
- User friendly touch-screen interface (GUI)
- Cleaning routine for valve maintenance
- Auto-purge (anti-gel function)
- Remote program select function

PC200 Setup



Connecting cable required for operation. Sold separately. [See page 73.](#)

Item Number	Description
PC200	Progressive Cavity Valve Controller

Specifications

Time Range	0.01 - 500s
Programs	200 memory slots
Voltage	100 - 240 VAC, 50/60 Hz
I/O	7 inputs / 7 outputs / RS485
Air Input	70 - 100 psi
Air Output	1 - 100 psi
Dimensions (WxDxH)	203.2 x 279.4 x 114.3 mm (8 x 11 x 4.5")
Weight	1,700 g (3.75 lb)
Standards	CE Approved, RoHS Compliant

Pz-CON Piezo Electric Valve Controller

The Pz-CON piezo electric valve controller can be configured to independently control up to 4 Pz1200 valves. The pre-fitted driver module(s) uses an amplifier to generate the correct signal wave to actuate and control the piezo elements within the valve ensuring precise dispense control.

The built-in memory allows up to 10 individual programs to be created containing pulse time and sequencing times & frequency. A built in USB connection also allows for programs to be remotely stored.

Each controller is supplied with three different user adjustable pulse definition profiles, which is critical when jetting fluid materials in order to minimize fluid build-up on the valve seat and unwanted satellites on substrate.

Features

- User friendly 7" touchscreen display
- User configurable I/O
- Control up to 4 valves
- Temperature control
- Operator lockout
- Valve purge screen
- 10 user programmable memories
- Trigger or continuous operation mode
- Remote program backup
- Programmable pulse definition profiles

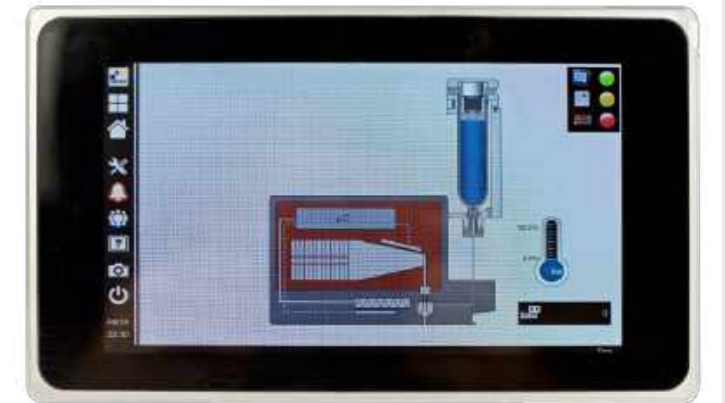
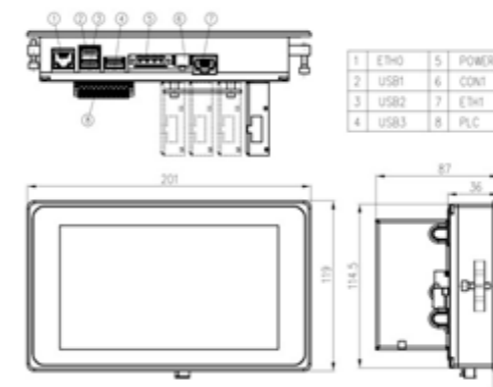

Power supply & valve connecting cable (4.5 m) included.

Item Number	Description
PZ-CON-1	Piezo Valve Controller - 1 Channel
PZ-CON-2	Piezo Valve Controller - 2 Channel
PZ-CON-3	Piezo Valve Controller - 3 Channel
PZ-CON-4	Piezo Valve Controller - 4 Channel

Specifications

Time Range	0.84 - 999ms
Programs	10 memory slots
I/O	3 inputs / 5 outputs
Input AC to Power Supply	96 - 264 VAC, 47 - 63 Hz
Output DC from Power Supply	24V / 11.67 A
Dimensions (WxDxH)	201 x 119 x 32.5 mm (8 x 4.7 x 1.3")
Weight	800 g (1.76 lb)
Standards	CE Approved, RoHS Compliant

Reservoirs & Pumps



IJ Series Reservoir Tanks

Reservoir tanks are used to feed bulk fluids to a variety of dispensing valves. A range of sizes are available including bottom ported for medium to high viscosity liquids and top ported for low to medium viscosities.

An "open top" style is used if liners are required to prevent the material from making contact with the sides of the container or if the fluid requires an agitator.

All reservoirs come standard with associated airline, fluid line, regulator, and fittings.



IJ2601N-SS-SP IJ2601N-SS IJ-0100 IJ-0100R IJ-0200



IJ-0200R IJ-0300 IJ-0300R IJ-83Z-211



IJ-83B-500 IJ-83B-500-SP IJ-83B-500-BK IJ-83G-510-SP

IJ Series Reservoir Tanks

Item Number	Capacity (Gallon)	Style	Ported	Riser	Base	Tank Material	Max Pressure (psi)	Overall Outer Dimension WxH (inches)	Material Hose O.D.
IJ2601N-SS-SP	0.5	Bottle	Top	PE	Metal	SS	50	6 1/2 x 8	1/4"
IJ2601N-SS	0.5	Bottle	Top	SS	Metal	SS	50	6 1/2 x 8	1/4"
IJ-0100	1	Bottle	Bottom	N/A	Metal	SS	125	9 x 12 9/16	3/8"
IJ-0100R	1	Bottle	Top	SS	Rubber	SS	125	9 x 9 1/4	1/4"
IJ-0200	2	Bottle	Bottom	N/A	Metal	SS	125	9 x 14 1/4	3/8"
IJ-0200R	2	Bottle	Top	SS	Rubber	SS	125	9 x 11 5/8	1/4"
IJ-0300	5	Bottle	Bottom	N/A	Metal	SS	125	9 x 24 15/16	3/8"
IJ-0300R	5	Bottle	Top	SS	Rubber	SS	125	9 x 22 1/2	1/4"
IJ-83Z-211	2.8	Top w/ Agitator	Top	SS	Metal	SS	80	13 3/8 x 23 5/8	1/4"
IJ-83B-500	2.8	Top	Top	Galvanized Steel	Metal	Galvanized Steel	80	13 3/8 x 20 1/2	1/4"
IJ-83B-500-SP	2.8	Top	Top	PE	Metal	Galvanized Steel	80	13 3/8 x 20 1/2	1/4"
IJ-83B-500-BK	2.8	Top	Top	PE	Metal	Galvanized Steel	80	13 3/8 x 20 1/2	1/4"
IJ-83G-510-SP	5	Top	Top	PE	Metal	Galvanized Steel	80	18 1/2 x 30 5/16	1/4"

Available Accessories

Item Number	Description
560554	Material shut off valve assembly
IJ-83B-RL	Replaceable liner for IJ-83B-500, IJ-83Z-211, IJ-83B-500-SP, and IJ-83B-500-BK
PTL-408-K20	Replaceable liner for IJ-83G-510-SP
560934B	Pressure Guage 0 - 100 psi - 1/8" NPT Side Mount
560779	Regulator
560944	O-ring EPDM for 1, 2, and 5 gallon bottle-style reservoirs
560944T	PTFE encapsulated Viton® O-ring for 1, 2, and 5 gallon bottle-style reservoirs

FT Series Top-Ported Reservoir Tanks

Designed with safety and quality in mind, Fisnar stainless steel fluid reservoir tanks maintain a steady fluid pressure for many dispensing applications.

Each model is available with a pneumatic agitation system installed with a powerful air motor for intermittent or constant fluid stirring/agitation.

The FT series of tanks contain a stainless steel construction offering high chemical resistance while preventing fluid contamination and evaporation.



Item Number	Capacity (Liters)	Style	Riser	Tank Material	Max Working Pressure (psi)	Overall Inner & Dimension WxH (mm)	Overall Outer Dimension WxH (mm)	Material Hose O.D. (inches)
FT1	1	Pneumatic Standard	PE	SS	100	100 x 135	182 x 225	1/4
FT1-AG	1	Pneumatic Agitated	SS	SS	100	100 x 135	182 x 330	1/4
FT2	2	Pneumatic Standard	PE	SS	100	100 x 270	182 x 360	1/4
FT2-AG	2	Pneumatic Agitated	SS	SS	100	100 x 270	182 x 465	1/4
FT5	5	Pneumatic Standard	PE	SS	100	152 x 300	202 x 390	1/4
FT5-AG	5	Pneumatic Agitated	SS	SS	100	152 x 300	202 x 495	1/4
FT10	10	Pneumatic Standard	PE	SS	100	200 x 359	237 x 482	1/4
FT10-AG	10	Pneumatic Agitated	SS	SS	100	200 x 359	237 x 605	1/4



FISNAR
www.fisnar.com
SERIAL NO. 291098

PP300-GL-A Clear View Pressure Chamber

A see-through pressure chamber for dispensing low viscosity liquids directly from bottles and up to 1 lb (0.45 kg) plastic jars.

Regulated air pressure forces the liquid in the bottle up through a disposable tube to a connector, which can be interfaced to a valve or dispensing pen.



Bottle and pen sold separately.

Item Number	Description
PP300-GL-A	Pressure Chamber

Specifications

Interior ID	91.44 mm (3.60")
Interior Height	220.98 mm (8.70")
Max Pressure	30 psi
External Dimensions (WxLxH)	152.4 x 152.4 x 279.4 mm (6 x 6 x 11")

Accessories

Item Number	Description
560607	Dispense Tube 0.07" I.D.
560608	Dispense Tube 0.10" I.D.
560609	Luer Lock Fitting 0.07" I.D.
560610	Luer Lock Fitting 0.10" I.D.
560620	Dip Tube
5606034	Safety Clip

Features

- All wetted disposable parts
- Material visual monitoring
- Glass chamber prevents blooming or crazing when using cyanoacrylates
- Suitable for most low-viscosity fluids

PP450-GL Clear View Pressure Chamber

A see-through pressure chamber for dispensing low to medium viscosity liquids directly from bottles and up to 1 lb (0.45 kg) plastic containers. Regulated air pressure forces the liquid in the bottle up through a disposable tube to a connector, which can be interfaced to a valve or dispensing pen.



Can also be used with 710PT-U & 700PTPCW pinch tube valve & pen.

Features

- Convenient quick pressure release slide valve
- Comes standard with a luer lock fitting for use with low-viscosity fluids
- Compatible with medium viscosity fluids when using supplied 1/4" fluid line kit
- All wetted disposable parts
- Material visual monitoring
- Glass chamber prevents blooming or crazing when using cyanoacrylates
- Operating pressure up to 60 psi

Specifications

Capacity	1.2 gal / 4.5 l
Maximum Operating Pressure	60 psi (4 bar)
Maximum Operating Temperature	100 °F (38 °C)
Minimum Operating Temperature	39 °F (4 °C)
Internal Diameter	150 mm (6")
Internal Height	254 mm (10")
External Width	165 x 165 mm (6.5 x 6.5")
External Height	406 mm (16")
Weight	3.5 kg (11 lb)

Item Number	Description
PP450-GL	4.5 Liter Pressure Chamber

Accessories

Item Number	Description
560620	Dip Tube
580047A-10-24	Fluid Line 0.10" I.D. x 24" Long
560657	Female Fitting 1/4" NPT x 1/4" Tube
5801450	Male Luer Lock Adapter
562320	Male LL Adapter 1/4" NPT x 1/8" FPT
562321	Male LL Adapter x 1/8" NPT
562322	PP Compression Fitting 1/4" NPT x 1/4" Tube
561415-IJ-10FT	P.E. Tubing 0.170" I.D. x 1/4" O.D.
561851	Air Line



1/4" Tube Fitting



Luer Lock Tube Fitting
For use with 710PT-U & 700PTPCW

DA35 Autocan Extruder System

The DA35 extrudes medium to high viscosity materials under pressure directly from a pre-filled can. This system is suitable for automatic and semi-automatic controlled dispensing applications, which require a constant supply of air-free material.

The extruder pump body is fitted with a follower plate that seals and follows the material as the level drops to wipe the sides of the can clean, limiting waste. Supplied as standard with a NBR wiper seal fitted. Optional FKM wiper seal sold separately.



Controller, hose, valve, and handle sold separately.

Features

- Prevents air bubbles and material voids
- Air ram assist to help drive material
- Simple load mechanism provides easy cleaning
- Easy hook up for automatic systems
- Low noise electric extruder model
- Integrated low level alarm and warning light

Specifications

Size	215 x 440 mm (8.46 x 17.32")
Height Adjustment	550 mm min - 720 mm max (21.65" min - 28.35" max)
Power Input for Sensing	110 - 220 VAC, 50 - 60 Hz
Air Input Pressure	30 - 100 psi
Maximum Output Pressure	850 psi
Fluid Viscosity Range	30,000 - 300,000 cps
Ratio	8.5
Volume/Stroke	5 cc
Max Pump Speed	60rpm
Air Inlet/Fluid Outlet Size	1/4" NPT (f)
Wetted Parts	PTFE, Viton®, and PEEK seals
Weight	12.73 kg (28 lb)

Models

Item Number	Description
DA35-1KG-US	Autocan Pump 110 VAC
DA35-3KG-US	Autocan Pump 110 VAC
DA35-1KG-EU	Autocan Pump 220 VAC
DA35-3KG-EU	Autocan Pump 220 VAC
DA35-1KG-UK	Autocan Pump 220 VAC
DA35-3KG-UK	Autocan Pump 220 VAC

Accessories

Item Number	Description
651780-A3A-B	Fluid Regulator SS 3,000 psi
EP1415K	Fluid Regulator Install Kit with Gauge Fittings
DA35-1KG	Follower Plate 1 kg
DA35-3KG	Follower Plate 3 kg
1300060-1KG-NBR	Follower Wiper Seal NBR (117 mm O.D.)
1300060-3KG-NBR	Follower Wiper Seal NBR (168 mm O.D.)
1300060-1KG-FKM	Follower Wiper Seal FKM (117 mm O.D.)
1300060-3KG-FKM	Follower Wiper Seal FKM (168 mm O.D.)

EP1305N Pail Extruder System

The EP1305N is designed for dispensing 5 gallon pails of medium to high viscosity fluid. Ideal for silicones and grease. Systems are rated at 15:1 and provide a maximum of 996 psi regulated material pressure.

The extruder pump body is fitted with a follower plate that seals and follows the material as the level drops to wipe the sides of the pail clean, limiting waste. The fluid is pressure-fed by reinforced hoses to a valve that is actuated by a valve controller.

The EP1305 utilizes a low-pulse pump design suitable for automatic production dispensing applications, when used with a fluid regulator. These applications require a constant supply of air-free material. Air bubbles and material voids, caused by handling or decanting high viscosity fluids, are prevented. Supplied standard with 20 kg follower plate.

Features

- Material delivered air free
- Wipe-clean action
- Air ram assist to help drive material and adjustable air ram pressure
- Electrical extruder motor
- Simple load mechanism for easy cleaning

Accessories

Item Number	Description
EP1305WP	Follower Plate for 20 kg (5 gallon pail)
EP1300LPS	Low Level Sensor
651780-A3A-B	Fluid Regulator SS 3,000 psi
EP1415K	Fluid Regulator Install Kit with Gauge and Fittings



Item Number	Description
EP1305N	Pump Electric 20 kg (5 Gallon 15:1 220 VAC)

Specifications

Size	500 x 400 x 1,200 mm (19.68 x 15.74 x 47.24")
Height Adjustment	755 mm min-1200 mm max (29.72" min x 47.24" max)
Power Input for Sensing	220 VAC, 50 - 60 Hz, 20 watts
Air Input Pressure	30 - 100 psi
Maximum Output Pressure	996 psi max
Fluid Viscosity Range	10,000 - 600,000 cps
Minimum Volume/Stroke	0.01 cc/shot
Max Operating Pressure	50 °C
Air Inlet/Fluid Outlet Size	1/4" NPT (f)
Wetted Parts	304 and 17-4 pH Stainless Steel, PTFE, Viton®, PEEK
Weight	24 kg (52.8 lb)

EP1310C Single Cartridge Pump System

A powerful, medium-ratio system for controlled fluid transfer from 1/10th gallon (310 ml) plastic cartridges. Suitable for silicone-type fluids, this low-pulse pump design can be used with a dispense valve or connected to an automatic production robot for controlled dispensing applications.

The EP1310C is designed to easily transfer material for controlled dispensing via a high pressure valve, providing a maximum of 995 psi regulated material pressure. The cartridge is contained with a metal-jacketed cylinder.



Item Number	Description
EP1310C	Pump Electric 1/10th Gallon

Specifications

Size	225 x 170 x 649 mm (8.86 x 6.69 x 25.55")
Pump Input for Sensing	220 VAC, 50 - 60 Hz, 20 watts
Air Input Pressure	30 - 100 psi
Maximum Output Pressure	995 psi
Fluid Viscosity Range	10,000 - 600,000 cps
Ratio	15
Minimum Volume/Stroke	0.01 cc/shot
Air Consumption	80 l/min
Cartridge Size	300 - 310 ml
Air Inlet/Fluid Outlet Size	1/4" NPT (f)
Wetted Parts	304 and 17-4 ph Stainless Steel, PTFE, Viton®, and PEEK seals
Weight	15 kg (33 lb)

Features

- Material delivered air free
- Wipe-clean action
- High-pressure regulation
- Pressure piston assist with adjustable piston pressure
- Electrical extruder motor
- Simple load mechanism for easy cleaning and easy automatic systems hook up

EP1320C Dual Cartridge Pump System

A powerful, medium-ratio system for controlled fluid transfer from 1/10th gallon (310 ml) plastic cartridges. Suitable for silicone-type fluids. The system integrates a dual (A+B) tandem cartridge arrangement for continuous-flow management. A low-pulse pump design allows automatic control of dispensing applications. The EP1320C is designed to easily transfer material for controlled dispensing via a high pressure valve.

Rated at 15:1 the system provides a maximum of 995 psi regulated material pressure. The A + B cartridge management automatically switches from either A to B or B to A when the cartridge is exhausted. Cartridges are contained in metal-jacketed cylinders.



Item Number	Description
EP1320C	Dual Cartridge Pump System 1/10th Gallon

Specifications

Size	272 x 288 x 649 mm (10.71 x 11.34 x 25.55")
Pump Input for Sensing	220 VAC, 50 - 60 Hz, 20 watts
Air Input Pressure	30 - 100 psi
Maximum Output Pressure	995 psi
Fluid Viscosity Range	10,000 - 600,000 cps
Minimum Volume/Stroke	0.01 cc/shot
Air Consumption	80 l/min
Air Inlet/Fluid Outlet Size	1/4" NPT (f)
Wetted Parts	304 and 17-4 ph Stainless Steel, PTFE, Viton®, and PEEK seals
Weight	18 kg (40 lb)

Features

- Material delivered air-free
- Wipe-clean action
- High-pressure regulation and adjustable pressure piston assist
- Electrical extruder motor
- Easy hook up for automatic systems

Fittings, Hoses, & Accessories

A selection of the most popular fittings, hoses, manifolds, regulators, and mufflers to fit your individual application needs.



Standard Plastic Fittings

	Item Number	Description	Material/Color
	560714	Elbow 1/4" O.D. Tube x 1/8" NPT Male	White
	560748	Elbow 1/4" O.D. Tube x 1/4" NPT Male	White
	914	Elbow 3/8" O.D. Tube x 1/4" NPT Male	White
	560714-BLACK	Elbow 1/4" O.D. Tube x 1/8" NPT Male	Black
	560748-BLACK	Elbow 1/4" O.D. Tube x 1/4" NPT Male	Black
	560715	Straight 1/4" O.D. Tube x 1/8" NPT Male	White
	560656	Straight 1/4" O.D. Tube x 1/4" NPT Male	White
	7610	Straight 3/8" O.D. Tube x 1/8" NPT Male	White
	913	Straight 3/8" O.D. Tube x 1/4" NPT Male	White
	560715-BLACK	Straight 1/4" O.D. Tube x 1/8" NPT Male	Black
	560656-BLACK	Straight 1/4" O.D. Tube x 1/4" NPT Male	Black
	7610BP	Straight 3/8" O.D. Tube x 1/8" NPT Male	Black
	913-BLACK	Straight 3/8" O.D. Tube x 1/4" NPT Male	Black
	560657	Straight Coupling 1/4" O.D. Tube x 1/4" NPT Female	White
	560726	Straight Coupling 3/8" O.D. Tube x 1/4" NPT Female	White
	561821	Elbow Female Luer Lock x 1/8" NPT Male	Clear
	561821-BLACK	Elbow Female Luer Lock x 1/8" NPT Male	Black
	5801451	Female Luer Lock Fitting x 1/4" NPT	Black
	5801452	Female Luer Lock x 0.170" Barb	Natural
	5801453	Male Luer Lock x 0.170" Barb	Natural
	5801454	Female Luer Lock Coupling	Natural
	561085	Female Luer Lock Fitting x 1/4" Barb	Clear
	561086	Male Luer Lock Fitting x 1/4" Barb	Clear

Standard Plastic Fittings

	Item Number	Description	Material/Color
	560914	Male Luer Lock x 10-32" NPT 50 UNF	Clear
	560936	Male Luer Lock x 1/4"-28 NPT 50 UNF	Clear
	560733	1/4"-28 UNF Male to Female Luer Lock Connector	Clear
	560734	Reducer 1/4"-28 UNF Female x 1/4" NPT Male	Clear
	561861	Reducer 1/8" NPT Female x 1/4" NPT Male	Clear
	560950N	Reducer 1/4"-28 UNF x 1/8" NPT Male	White
	560906N	T Fitting 5/32" I.D. x 1/4" O.D. Tube	Nylon/White
	561402N	Barbed Elbow x 1/8" NPT Male	Nylon/Natural
	561401	Barbed Fitting x 1/8" NPT Female	Nylon/Natural
	560710	Luer Lock Cap Male	Clear
	561105	Street Elbow 1/4" NPT Female x 1/4" NPT Male	P.E./Clear
	2004BA	Female Quick Connect to Barb Fitting 5/32" I.D. x 1/4" O.D.	Black
	561427H	Female Quick Connect to Barb Fitting 1/8" x 1/4" O.D.	Black
	5606035	Male Quick Connect for 0.093" I.D. Tubing	Black
	5601064	Male Quick Connect for 1/8" I.D. Tubing	Black
	5606038	1/4" Stem x 5/32" Barb	Green
	560546	Cartridge Adapter 1/4" NPT Female	White Polyethylene
	562317	Cartridge Adapter 1/4" NPT x 13/16"-14 UNC	Black Acetal
	561129	Cartridge Adapter 1/4" NPT x 5/8"-11 UNC	White Acetal
	5801450	Male Luer Lock x 1/4" NPT Male Adapter	White Polypropylene
	5801449	Male Luer Lock x 1/4" NPT Male Adapter	Black Polypropylene
	A-10001-OT	Male Luer Lock x M8 Male Adapter	White Polypropylene

Standard Metal Fittings

	Item Number	Description	Material/Color
	561129-SS	Cartridge Adapter 1/4" NPT x 5/8"-11 UNC	Stainless Steel
	5801420	Male Luer Lock x 1/4" NPT Male Adapter	Metal
	560953	Male Luer Lock x 1/8" NPT Male Adapter	Metal
	560716	Nipple 1/4" NPT Male	Brass
	560718	Nipple 1/8" NPT Male	Brass
	560614	Reducing Nipple 1/4" NPT Male to 1/8" NPT Male	Brass
	560719	Bushing 1/4" NPT Male x 1/8" NPT Female	Brass
	560924	Bushing 3/8" NPT Male x 1/4" NPT Female	Brass
	560717	Bushing 1/2" NPT Male x 1/4" NPT Female	Brass
	560759	Bushing 3/4" NPT Male x 1/4" NPT Female	Brass
	560727	Adapter 1/8" NPT Male x 1/4" NPT Female	Brass
	560727SS	Adapter 1/8" NPT Male x 1/4" NPT Female	Stainless Steel
	560634	1/4" NPT Female Coupling	Brass
	560747	Elbow 1/4" NPT Male x 1/4" NPT Female	Brass
	560945	Street T 1/4" NPT Male x 1/4" NPT Female	Brass
	560757	Hex Head Plug 1/4" NPT Male	Brass
	560758	Hex Head Plug 3/8" NPT Male	Brass
	560701	Straight Barbed Fitting 1/8" I.D. Tube x 1/8" NPT Female	Brass
	560704	Straight Barbed Fitting 1/8" I.D. Tube x 1/4" NPT Male	Brass
	560737	Straight Barbed Fitting 1/4" I.D. Tube x 1/4" NPT Male	Brass
	560728	Barbed Elbow 1/8" I.D. Tube x 1/8" NPT Female	Brass
	560732	Barbed Elbow 1/8" I.D. Tube x 1/8" NPT Male	Brass
	560713	Barbed Elbow 1/8" I.D. Tube x 1/4" NPT Male	Brass
	560724	Elbow 1/4" NPT Male x 1/4" NPT Male	Brass
	560724SS	Elbow 1/4" NPT Male x 1/4" NPT Male	Stainless Steel
	560729	Elbow 1/4" NPT Male x 1/8" NPT Female	Brass

Specialty Fittings

Item Number	Description	Material/Color
560746A	Straight 1/4" O.D. Push Connector x 1/4" NPT Male	Metal
561694	Straight 1/4" O.D. Push Connector x 1/8" NPT Male	Metal
560762	Straight 1/4" O.D. Compression Fitting x 1/4" NPT Male	Brass
560725	Swivel Elbow 1/4" O.D. Push Connector x 1/8" NPT Male	Metal
561964	Swivel Elbow 1/4" O.D. Push Connector x M5 Male	Black
5779K712	Push Connect Air Fitting (1/4" stem x 5/32" tube O.D.)	Black
580057	Female Quick Connect x 1/4" NPT Male	Black
51495K173	1/4" O.D. Push to Connect Air Plug	Black
560795	T for 1/4" O.D. Tube	Metal
560784	1/4" Push Connect Socket x 1/4" NPT Female	Metal
560785	1/4" Plug x 1/4" NPT Male	Metal
560703	1/4" Plug x 1/4" NPT Female	Metal
5601062	Hose Clamp 1/4" Tube	Metal
560779	Pressure Regulator 0 - 100 psi	Black
560934B	Pressure Gauge 0 - 100 psi - 1/8" NPT Side Mount	Black
560611	Pressure Gauge 0 - 30 psi - 1/8" NPT Top Mount	Black
561399-NON IJ	Pressure Gauge 0 - 100 psi - 1/8" NPT Panel Mount	Black
561193B	Pressure Gauge 0 - 15 psi - 1/8" NPT Panel Mount	Black
561871B	Vacuum Gauge 0 - 30 psi - 1/8" NPT Panel Mount	Black
560616-50	Pressure Relief Valve 50 psi Max - 1/8" NPT	Brass
560763	Pressure Relief Valve 125 psi Max - 1/4" NPT	Brass
560949	Slide Air Valve	Brass

Air Manifold

Air manifolds provide the capacity of connecting up to four valves to one dispenser.

Item Number	Description
560057	4 Port Air Manifold (1/4" Tube)
51495K173	1/4" O.D. Push to Connect Air Plug



Tube Fluid Manifold

Fluid manifolds provide the capability of supplying material from one reservoir to up to four valves. Suitable for 1/4" or 3/8" tubing.

Item Number	Description
560542-1/4	4 Port Fluid Manifold (1/4" Tube)
560542-3/8	4 Port Fluid Manifold (3/8" Tube)
EA4P	Threaded Square Plug PE



Luer Lock Fluid Manifold

Fluid manifolds provide the capability of supplying material from one reservoir to up to four valves. Suitable for use with 1/4" or 3/8" O.D. fluid feed tubing.

Item Number	Description
560542LL	4 Port Fluid Manifold (Luer Lock)
8001039	Pointed Tip Cap
913-BLACK	Straight 3/8" O.D. Tube x 1/4" NPT Male
560656-BLACK	Straight 1/4" O.D. Tube x 1/4" NPT Male
5801449	Male Luer Lock x 1/4" NPT Male Adapter



Mufflers for Benchtop Controllers

Mufflers filter air output up to 0.5 microns and provide muffling of exhaust air where reduced operating noise is required.

Item Number	Description
560024	Clean Room Filter Muffler (1/4" O.D.)
560024DC	Clean Room Muffler for DC Controllers (10-32 UNF)



RESERVOIRS/PUMPS

RESERVOIRS/PUMPS

Air Filter Regulator

Air Filter Regulator assembly is designed to remove moisture and particulates from compressed air sources up to 5 microns. Recommended for use with Fisnar controllers and reservoirs.



Item Number	Description
560567	5 Micron Air Filter

Air Filter Regulator with Coalescer

Air Filter Regulator assembly with coalescer provides extra filtration for capturing remaining moisture and oils up to 5 microns. Generally suggested when dispensing cyanoacrylate adhesives.



Item Number	Description
560567C	5 Micron Air Filter Regulator Assembly with Coalescer

Air Pressure Regulator

Pressure regulator for cartridge reservoirs and syringes when constant pressure is required.



Item Number	Description
560779SK	Air Regulator Assembly for Syringe Barrel Adapter

Tubing

Fluid tubing is available in a range of sizes, colors, and materials for a variety of dispensing requirements. Bulk roll sizes also available.

	Item Number	Descriptions	Material/Color
	560722-10FT	0.250" O.D. x 0.188" I.D. Tubing	PTFE/Natural
	5601060-10FT	1/4" O.D. x 1/8" I.D. Tubing	PVC/Clear
	560750-10FT	3/8" O.D. x 3/16" I.D. Tubing	PVC/Clear
	560705-10FT	1/4" O.D. x 0.145" I.D. Tubing	Polyurethane/White
	561400-10FT	1/4" O.D. x 1/8" I.D. Tubing	Polyurethane/Blue
	5606030-100FT	0.152" O.D. x 0.093" I.D. Tubing	Polyurethane/Clear
	561415-IJ-10FT	1/4" O.D. x 0.170" I.D. Tubing	Polyethylene/Natural
	561416-10FT	3/8" O.D. x 1/4" I.D. Tubing	Polyethylene/Natural
	560743-10FT	1/4" O.D. x 0.170" I.D. Tubing	Polyethylene/Black
	560744-10FT	3/8" O.D. x 1/4" I.D. Tubing	Polyethylene/Black
	562066-10FT	6 mm O.D. x 4 mm I.D. Tubing	Polyethylene/Natural

Robotics

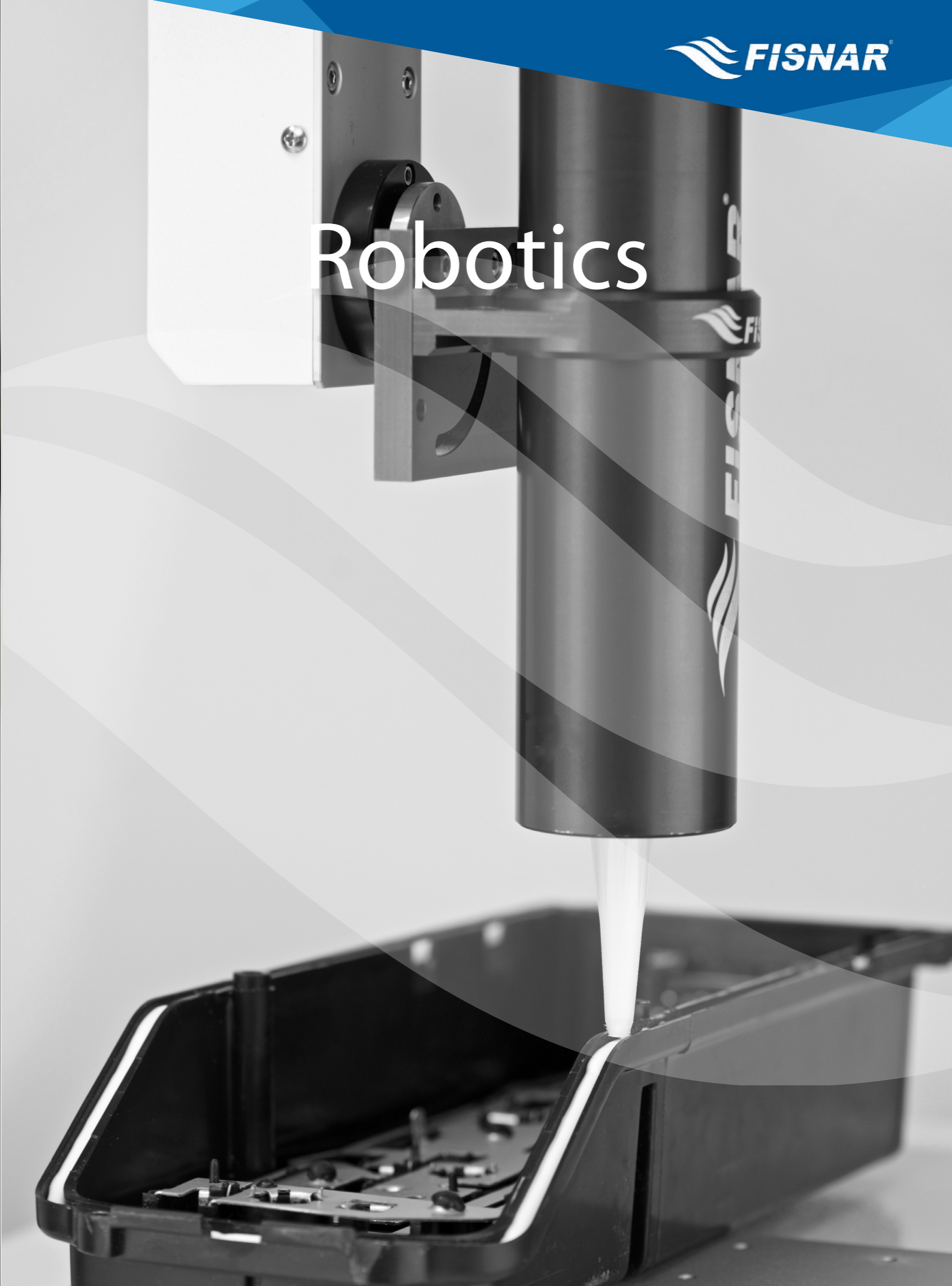

F1300N Rotary Table

The F1300N rotary table provides an efficient method of dispensing a circular pattern on areas that are difficult to access. The tilting Z-axis allows for controlled rotary dispensing at a fixed angle.

Used for dispensing adhesives, silicones, greases, and lubricants, the F1300N is fully adjustable in rotation speed, circle diameter, and dispensing time. Dispense from barrels, cartridges, or valves mounted on the Z-axis.

The Z-axis tilt is easily adjusted to dispense either on a vertical wall within a cylindrical part or on an outside wall. The system is fully programmable to control dispense delay, degree of rotation, and wait period before cycling.

Features

- Touch screen LCD display for easy set up and operation
- Fully programmable for accurate dispensing
- 9 user programmable memories
- Password-protected operator lock-out mode
- I/O interface



Item Number	Description
F1300N	Rotary Table

Specifications

Item Number	F1300N
Cycle Initiation	Manual or Automatic
Vertical Travel	50 mm (2") other lengths optional
Rotation Speed	0 - 60rpm
Air Input	70 - 100 psi (5 - 7 bar)
Air Output	1 - 100 psi (5 - 7 bar)
Dimensions (WxDxH)	350 x 482 x 575 mm (13.8 x 19 x 22.6")
Work Load	2 kg (4.4 lb)
Tool Load	10 kg (22 lb)
Working Area (Diameter)	300 mm (12")
Weight	11 kg (24.3 lb)

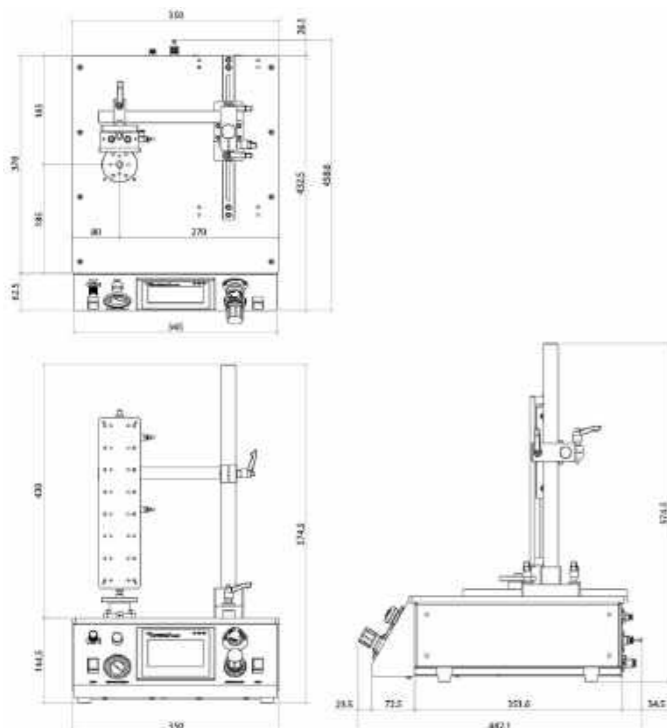

F4200N.2 Compact Benchtop Robot

The F4200N.2 is a compact, ergonomic, and economically priced benchtop robot, to support most light-duty entry level dispensing applications which require a high performance standard.

Programming the F4200N.2 robot is simple with the included teach pendant and user-friendly proprietary software. This allows a sophisticated dispensing operation to be created and operational in minutes.

The optional automatic tip-alignment and height detect device further improve machine performance by increased productivity and process control.

The F4200N.2 robot can be supplied individually or as a complete stand-alone machine system by integrating into a safety enclosure.*

*Required to conform to European CE safety regulations (Machinery Directive 2006/42/EC).

Features

- Repeatability 0.02 mm
- Small footprint for bench space reduction
- Step and repeat functionality
- USB port for data transfer and back up
- Optional PC programming



Item Number	Description
F4200N.2	Compact Benchtop Robot

Specifications

Item Number	F4200N.2
Working Area (X/Y/Z)	200 x 200 x 50 mm
Maximum Speed (X&Y/Z)	500 / 200 mm / secs
Work Load	3 kg
Tool Load Z-Axis	2 kg
Repeatability	+/- 0.02 mm / axis
Resolution	0.001 mm / axis
Motion Control	PTP & CP
Drive System	Micro stepping motors
Data Memory	1 - 100 programs 50,000 points/program
I/O Signals	8 inputs / 8 outputs
External Interface	USB / RS232
Power Supply	Auto-switching AC 100 - 240 VAC, 320 watts
Dimensions (WxDxH)	324 x 499 x 480 mm (12.75 x 19.7 x 18.9")
Weight	17 kg (37.5 lb)

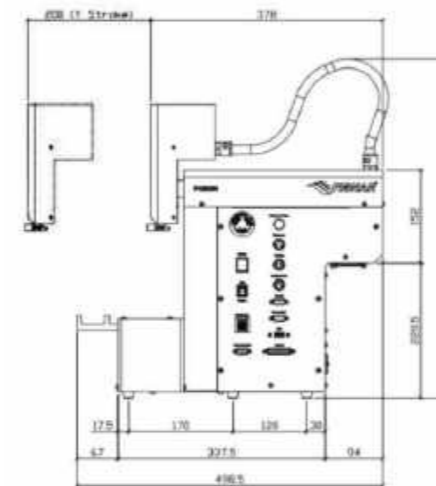

F4000 ADVANCE Series 3-Axis Robot

Fisnar F4000 ADVANCE 3-axis benchtop robots are designed to ensure precise fluid placement and positioning. When configured with a syringe, cartridge, or valve system, a high level of accuracy and repeatability is achieved. Specifically built for fluid dispensing processes, the F4000 ADVANCE proprietary robot software is user friendly and enables the creation of complex dispensing routines (dots, lines, circles, arcs, and fills) that can be set up and operational in just minutes using the teach pendant (included).

The proprietary windows programming software allows for DXF files to be imported into the software and have dispense lines or dots quickly created from the imported CAD data. This feature dramatically reduces programming time for complex dispense patterns or when there is a high number of dispense positions.

The F4000 ADVANCE can be supplied individually or as a complete stand-alone machine system by integrating into a safety enclosure.*

*Required to conform to European CE safety regulations (Machinery Directive 2006/42/EC).

Features

- Modular connectivity for easy installation of accessories at any time such as the CCD vision kit, tip-alignment, or height sensor
- USB port for data transfer and back up
- Program selector switch and fluid purge button
- True 3D interpolation and simultaneous motion control
- Teach pendant included for easy programming



Models

Item Number	Description
F4303N ADVANCE	3-Axis Robot 300x300x100 mm Work Area
F4403N ADVANCE	3-Axis Robot 400x400x100 mm Work Area
F4503N ADVANCE	3-Axis Robot 500x500x150 mm Work Area
F4603N ADVANCE	3-Axis Robot 600x500x150 mm Work Area

Benefits

- High positional accuracy improves dispense results
- Proprietary user-friendly software allows programs to be easily and quickly set up using the teach pendant or PC
- Increased productivity due to faster cycle times and less rejects
- Windows software provides greater control and visibility of complete dispense program

F4000 ADVANCE Series 3-Axis Robots

Specifications

Item Number	F4303N ADVANCE	F4403N ADVANCE	F4503N ADVANCE	F4603N ADVANCE
Maximum Working Area (X/Y/Z)	300 x 300 x 100 mm (12 x 12 x 4")	400 x 400 x 100 mm (16 x 16 x 4")	500 x 500 x 150 mm (20 x 20 x 6")	600 x 500 x 150 mm (24 x 20 x 6")
Maximum Speed (X&Y/Z)	800 / 320 mm / secs (31 / 13" / secs)			
Work Load	10 kg (22 lb)			
Tool Load	5 kg (11 lb)			
Repeatability	+/- 0.008 mm**			
Motion Control	PTP & CP			
Drive System	3-phase micro stepping motors			
Data Memory	1 - 100 programs 1 - 50,000 points / program			
I/O Signals	8 inputs / 8 outputs			
External Interface	USB / RS232			
Power Supply	Auto-switching AC 100 - 240 VAC, 320 watts			
Dimensions (WxDxH)	490 x 517 x 645 mm (19 x 20 x 25")	590 x 617 x 645 mm (23 x 24 x 25")	690 x 717 x 815 mm (27 x 28 x 32")	810 x 717 x 815 mm (32 x 28 x 32")
Weight	21 kg (46 lb)	39.5 kg (87 lb)	44.5 kg (98 lb)	47kg (104 lb)
Approvals	CE, RoHS, WEE			

**Repeatability value will vary depending on measurement method.

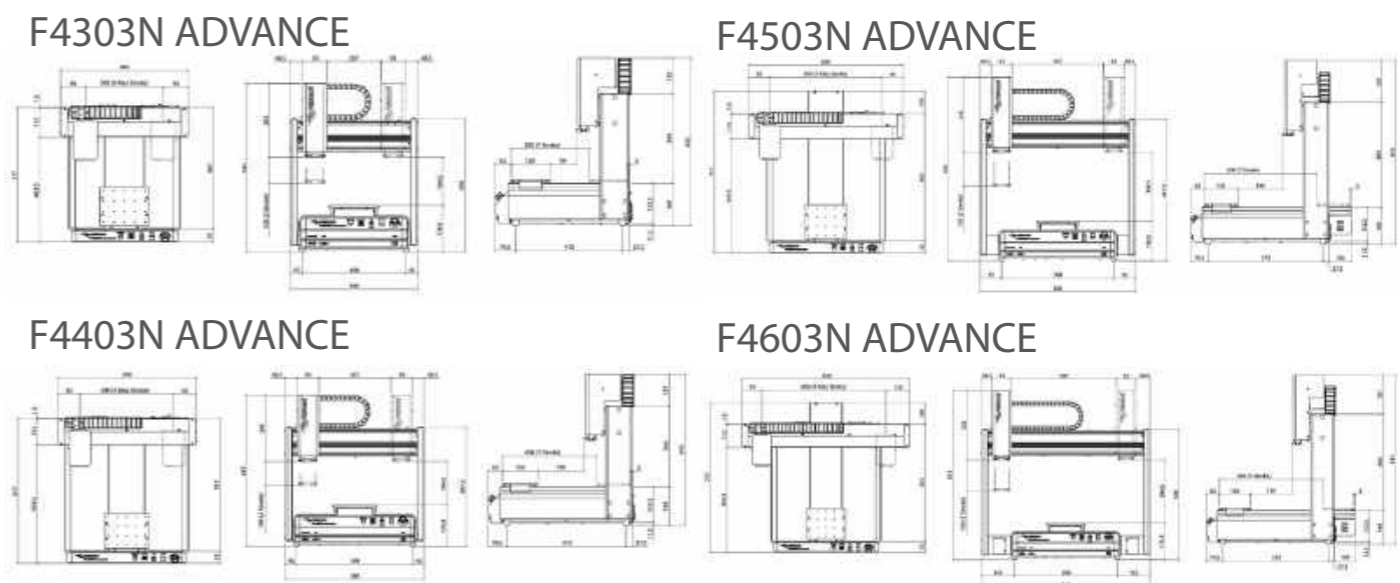

F4000 ELITE Series 3-Axis Robot

Fisnar F4000 ELITE 3-axis benchtop robots are designed to offer the highest level of precise automated fluid placement and positioning.

The CCD camera vision system and laser height sensor (sold separately) allow the system to automatically adjust for changes in part position/orientation and height.

Specifically built for fluid dispensing processes, the F4000 ELITE proprietary robot vision software is user friendly and enables the set-up and running of complex dispensing routines to be created easily.

The additional auxiliary camera allows for real-time viewing, image capturing, and recording of the dispense path.

Additional functionality features CAD import and an offline measuring tool to further improve the user's control of the dispensing process.

The F4000 ELITE can be supplied individually or as a complete stand-alone machine by integrating into a safety enclosure.

**Required to conform to European CE safety regulations (Machinery Directive 2006/42/EC).*

Features

- Dual linear guide and ball screw mechanism
- Servomotor drive control with closed loop encoder feedback
- CCD camera vision & PC kit with automated tip-alignment
- Laser Height Detect Kit included
- Fiducial Recognition System
- Real-time preview & recording of dispense cycle path
- Process functionality tools such as CAD import, measuring & image capture/recording



Models

Item Number	Description
F4303N ELITE	3-Axis Robot - 300x300x100 mm Work Area
F4403N ELITE	3-Axis Robot - 400x400x100 mm Work Area

Benefits

- Highest level of positional repeatability +/- 0.003 mm improves dispense results
- Proprietary user-friendly camera vision software ensures a quicker and easier learning curve for users to set-up dispense programs
- Increased productivity due to faster cycle times and less rejects
- More precise and accurate dispense results regardless of dimensional variations of component parts
- Improved process control and quality due to additional software functionality tools

F4000 ELITE Series 3-Axis Robots

Specifications

Item Number	F4303N ELITE	F4403N ELITE
Maximum Working Area (X/Y/Z)	300 x 300 x 100 mm (12 x 12 x 4")	400 x 400 x 100 mm (16 x 16 x 4")
Maximum Speed (X&Y/Z)	800 / 250 mm / secs	
Work Load	25 kg (55 lb)	
Tool Load	6 kg (13 lb)	
Repeatability	+/- 0.003 mm**	
Motion Control	PTP & CP	
Drive System	Servo Motor	
Data Memory	PC Storage	
I/O Signals	8 inputs / 8 outputs	
External Interface	USB / RS232	
Power Supply	Auto-switching AC 100 - 240 VAC, 320 watts	
Dimensions (WxDxH)	681 x 575 x 687.5 mm (27 x 23 x 27")	781 x 675 x 687.5 mm (31 x 26.5 x 27")
Weight	49 kg (108 lb)	54 kg (119 lb)
Approvals	CE, RoHS, WEE	

**Repeatability value will vary depending on measurement method.

F4303N ELITE

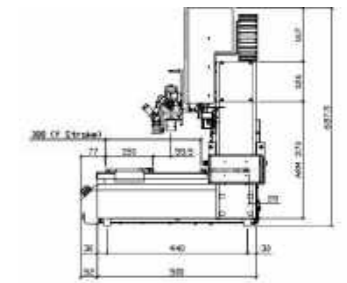
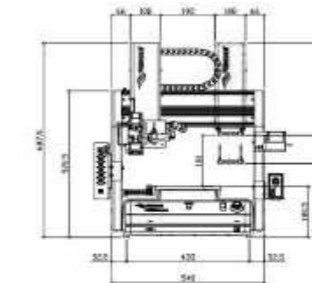
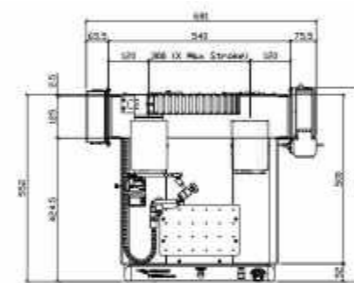

F4403N ELITE

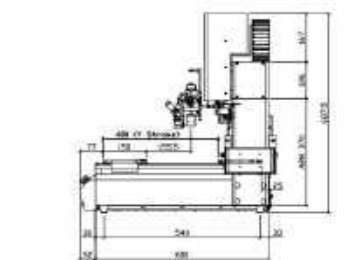
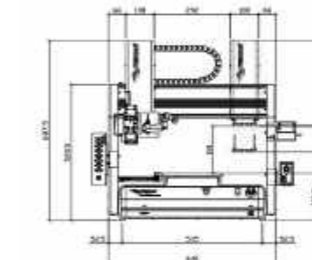
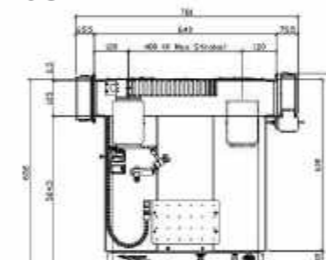

F4000 ADVANCE Series 4-Axis Robot

Fisnar F4000 ADVANCE series 4-axis benchtop robots are designed to ensure precise fluid placement and positioning.

Specifically made for fluid dispensing processes, the F4000 ADVANCE proprietary robot software is user friendly and enables the creation of complex dispensing routines (dots, lines, circles, arcs, and fills) that can be set up and operational in just minutes using the teach pendant (included).

The additional 4th rotational (R) axis allows for dispensing at a user-specified, fixed angle around the 360° rotational plane, allowing it to access hard-to-reach areas and vertical surfaces.

The F4000 ADVANCE can be supplied individually or as a complete stand-alone system by integrating into a safety enclosure.*

*Required to conform to European CE safety regulations (Machinery Directive 2006/42/EC).



Models

Item Number	Description
F4304N ADVANCE	4-Axis Robot 300x300x150 mm Work Area
F4404N ADVANCE	4-Axis Robot 400x400x150 mm Work Area
F4504N ADVANCE	4-Axis Robot 500x500x150 mm Work Area
F4604N ADVANCE	4-Axis Robot 600x500x150 mm Work Area

Features

- Integral tip position adjustment routine
- USB port for data transfer and back-up
- Program selector switch and fluid purge button
- True 3D interpolation and simultaneous motion control
- Modular connectivity design for the simple installation of productivity enhancement tools

Benefits

- High positional accuracy improves dispense results
- Proprietary user-friendly software allows programs to be easily and quickly set up using the teach pendant
- Increased productivity due to faster cycle times and less rejects

F4000 ADVANCE Series 4-Axis Robots

Specifications

Item Number	F4304N ADVANCE	F4404N ADVANCE	F4504N ADVANCE	F4604N ADVANCE
Maximum Working Area (X/Y/Z)	300 x 300 x 150 mm (12 x 12 x 6")	400 x 400 x 150 mm (16 x 16 x 6")	500 x 500 x 150 mm (20 x 20 x 6")	600 x 500 x 150 mm (24 x 20 x 6")
Max Working Area (R)	+/- 720°			
Maximum Speed (X&Y/Z)	800 / 320 mm / secs (31 / 13" / secs)			
Maximum Speed (R)	720° / secs			
Work Load	10 kg (22 lb)			
Tool Load	5 kg (11 lb)			
Repeatability	+/- 0.008 mm**			
Motion Control	PTP & CP			
Drive System	3-phase micro stepping motors			
Data Memory	1 - 100 programs 1 - 50,000 points / program			
I/O Signals	8 inputs / 8 outputs			
External Interface	USB / RS232			
Power Supply	Auto-switching AC 100 - 240 VAC, 320 watts			
Dimensions (WxDxH)	540 x 552 x 914 mm (21 x 22 x 36")	640 x 652 x 914 mm (25 x 30 x 36")	740 x 752 x 914 mm (29 x 30 x 36")	860 x 752 x 914 mm (32 x 30 x 36")
Weight	41 kg (90 lb)	46 kg (101 lb)	48 kg (106 lb)	52 kg (115 lb)
Approvals	CE, RoHS, WEE			

**Repeatability value will vary depending on measurement method.

F4304N ADVANCE

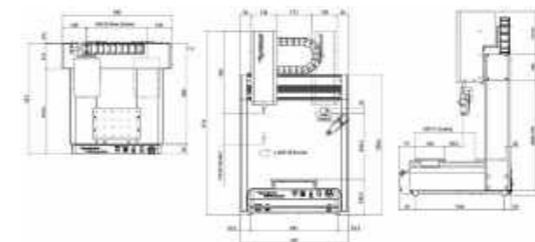

F4504N ADVANCE

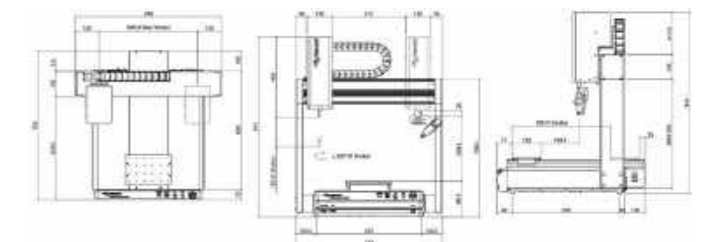

F4404N ADVANCE

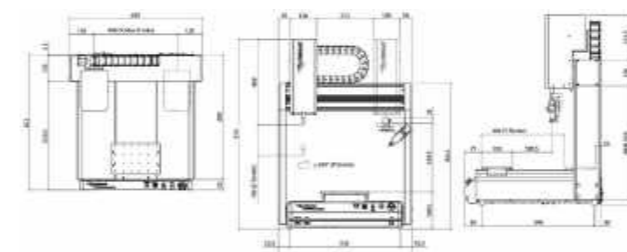

F4604N ADVANCE

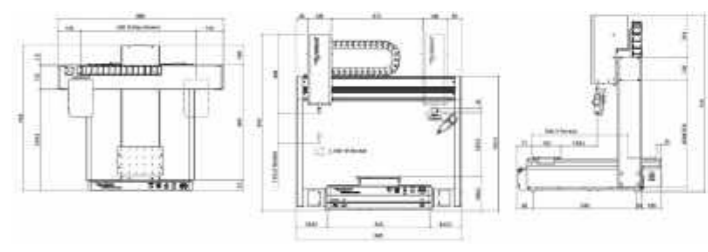

F4000 ADVANCE 5-Axis Robot

Fisnar F4000 ADVANCE 5-axis benchtop robot provides both a rotational vertical (B) axis and horizontal (U) axis for applying adhesives and sealants on curved, vertical, or difficult to reach applications.

The F4000 ADVANCE proprietary robot software is user friendly and enables the creation of complex dispensing routines (dots, lines, circles, arcs, and fills) that can be set up and operational in just minutes.

The 5-axis simultaneous positioning is also ideal for dispensing around ledges, lips, and inside channels with form-in-place gasketing materials or staking/ruggedizing electrical components on a PCB with a silicone RTV material. The F4000 ADVANCE can be supplied individually or as a complete stand-alone machine system by integrating into a safety enclosure.*

*Required to conform to European CE safety regulations (Machinery Directive 2006/42/EC).



Item Number	Description
F4505N ADVANCE	5-Axis Robot 500x500x150 mm Work Area

Features

- Integral tip position adjustment routine
- USB port for data transfer and back-up
- Program selector switch and fluid purge button
- True 3D interpolation and simultaneous motion control
- Modular connectivity design for the simple installation of productivity enhancement tools

Benefits

- High positional accuracy improves dispense results
- Proprietary user-friendly robot software allows programs to be easily and quickly set up using the teach pendant or PC
- Increased productivity due to faster cycle times and less rejects

F4000 ADVANCE Series 5-Axis Robots

Specifications

Item Number	F4505N ADVANCE
Maximum Working Area (X/Y/Z)	500 x 500 x 150 mm (20 x 20 x 6")
Max Working Area (R)	+/- 720°
Maximum Speed (X&Y/Z)	800 / 320 mm / secs (31 / 13" / secs)
Maximum Speed (R)	720° / secs
Work Load	10 kg (22 lb)
Tool Load	1 kg (2.2 lb)
Repeatability	+/- 0.008 mm**
Motion Control	PTP & CP
Drive System	5-phase micro stepping motors
Data Memory	1 - 99 programs 1 - 50,000 points / program
I/O Signals	8 inputs / 8 outputs
External Interface	USB / RS232
Power Supply	Auto-switching AC 100 - 240 VAC, 320 watts
Dimensions (WxDxH)	860 x 752 x 1,065 mm (34 x 30 x 42")
Weight	48 kg (106 lb)
Approvals	CE, RoHS, WEE

**Repeatability value will vary depending on measurement method.

F4505N ADVANCE

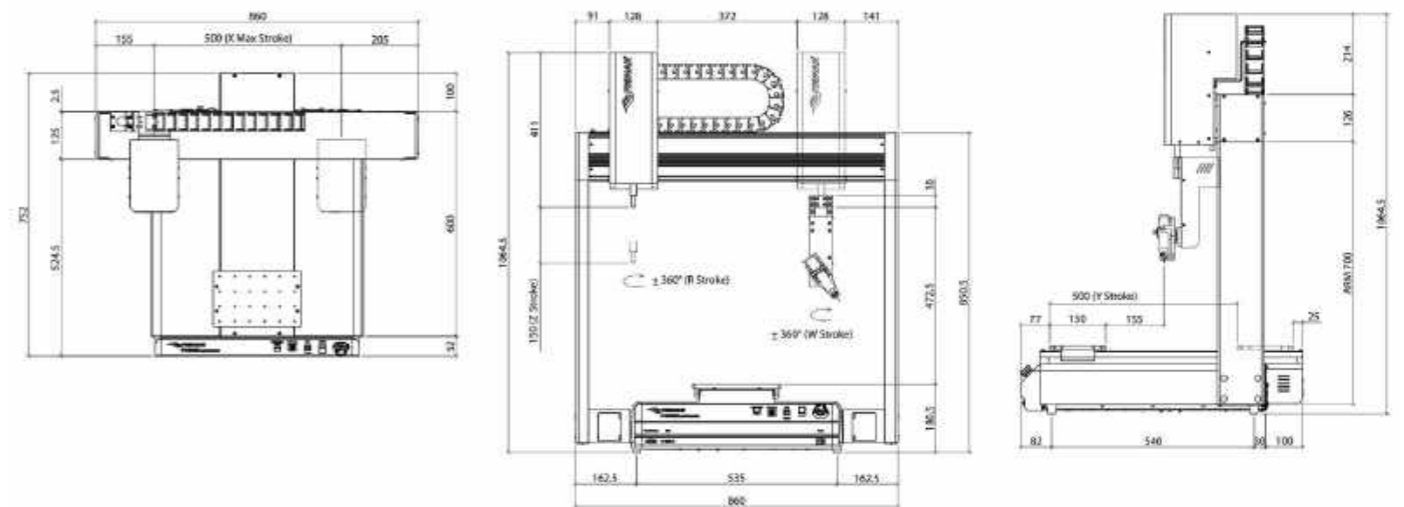

F4000 ADVANCE Series Dual Table Robot

F4000 ADVANCE dual table benchtop robots are designed to ensure precise fluid placement and positioning.

The unique dual-table design allows for high speed manufacturing due to the elimination of part changeover and loading time. This is made possible with the removal of finished parts and the loading of new parts on the fixture of one table, while the other table is being processed by the robot.

Furthermore, the dual-table design provides users the option to carry out two different dispensing routines sequentially, thus eliminating the requirement for batch production.

The F4000 ADVANCE can be supplied individually or as a complete stand-alone machine system by integrating into a safety enclosure.*

*Required to conform to European CE safety regulations (Machinery Directive 2006/42/EC).



Models

Item Number	Description
F4553N ADVANCE	3-Axis Robot 500x500x100 mm Work Area
F4554N ADVANCE	4-Axis Robot 500x500x150 mm Work Area

Features

- Unique dual-table design for high speed manufacturing
- USB port for data transfer and back-up
- Program selector switch and fluid purge button
- True 3D interpolation and simultaneous motion control
- Modular connectivity interface

Benefits

- Dual-table design increases production rates
- Independent control of each table
- High positional accuracy improves dispense results
- Proprietary user-friendly robot software allows programs to be easily and quickly set up using the teach pendant
- Increased productivity due to faster cycle times and less rejects

F4000 ADVANCE Series Dual Table Robot Specifications

Item Number	F4553N ADVANCE	F4554N ADVANCE
Maximum Working Area (X/Y/Z)	500 x 500 x 100 mm (20 x 20 x 4")	500 x 500 x 150 mm (20 x 20 x 6")
Maximum Working Area (R)	+/- 720°	
Maximum Speed (X&Y/Z)	800 / 320 mm / secs (31 / 13" / secs)	
Maximum Speed (R)	720° / secs	
Work Load	10 kg (22 lb)	
Tool Load	5 kg (11 lb)	
Repeatability	+/- 0.008 mm**	
Motion Control	PTP & CP	
Drive System	3-phase micro stepping motors	
Data Memory	1 - 100 programs 1 - 50,000 points / program	
I/O Signals	8 inputs / 8 outputs	
External Interface	USB / RS232	
Power Supply	Auto-switching AC 100 - 240 VAC, 320 watts	
Dimensions: (WxDxH)	740 x 717 x 659 mm (30 x 28 x 26")	740 x 717 x 916 mm (30 x 28 x 36")
Weight	52 kg (115 lb)	56 kg (123 lb)
Approvals	CE, RoHS, WEE	

**Repeatability value will vary depending on measurement method.

F4553N ADVANCE



F4554N ADVANCE

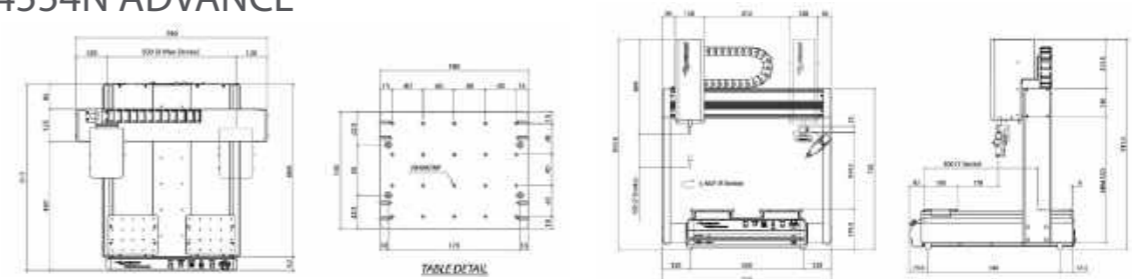

F5000 3-Axis Series Gantry Robots

The F5000 series robots are compact and cost-effective gantry style robots with all moving axes above the work piece. The Unitop™ design is suitable for dispense applications requiring a configuration that provides open access under the robot.

These robots are ideal for conveyor-fed automation lines or installed into automated work cells. They are also advantageous when component weight or size prevent a conventional benchtop robot from being used.

Programming and control can be carried out via teach pendant, RS232, or proprietary PC software (sold separately).



Item Number	Description
F5200N.2	3-Axis Inline Gantry Robot
F5300N.2	3-Axis Inline Gantry Robot

Features

- Compact and lightweight gantry-style design
- Work area up to 300 x 300 mm
- Axis repeatability 0.02 mm
- Durable linear belt drive system for industrial applications
- USB port for data transfer
- RS232 port for remote operation
- Modular connectivity interface

Benefits

- Separate control box reduces robot footprint
- Separate control box allows robot to be used in vacuum chamber and glovebox work environments
- Open access under robot for dispensing onto oversize and heavy components
- Can be used as part of a conveyor-fed automation solution for increased throughput
- Proprietary offline robot PC software allows for basic programming, editing of robot programs plus a CAD import utility tool

F5000 3-Axis Series Gantry Robots

Specifications

Item Number	F5200N.2	F5300N.2
Maximum Working Area (X/Y/Z)	200 x 200 x 150 mm (8 x 8 x 6")	300 x 300 x 150 mm (12 x 12 x 6")
Maximum Speed (X&Y/Z)	500 / 320 mm / secs (20 / 13" / secs)	
Tool Load	2 kg (4.4 lb)	
Repeatability	+/- 0.02 mm / axis	
Resolution	0.001 mm / axis	
Motion Control	PTP & CP	
Drive System	Micro stepping motors	
Data Memory	1 - 100 programs 50,000 points / program	
I/O Signals	8 inputs / 8 outputs	
External Interface	USB / RS232	
Power Supply	Auto-switching AC 100 - 240 VAC, 320 watts	
Dimensions (WxDxH)	485 x 384 x 569 mm (19 x 15 x 22.5")	595 x 483 x 569 mm (23.5 x 19 x 22.5")
Weight	25 kg (55 lb)	28 kg (62 lb)
Approvals	CE, RoHS, WEE	

F5200N.2

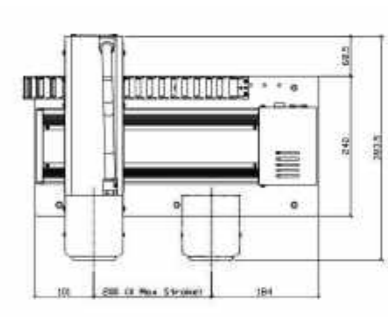
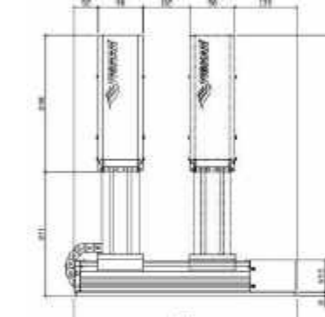
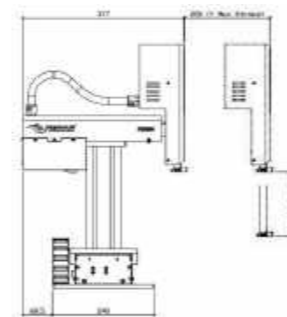

F5300N.2

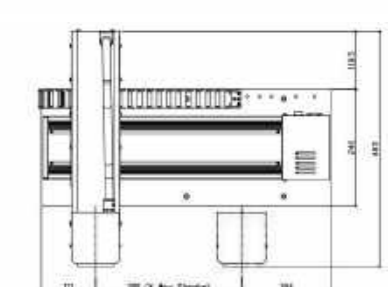
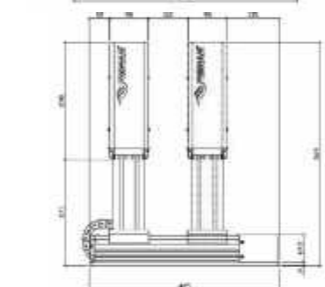
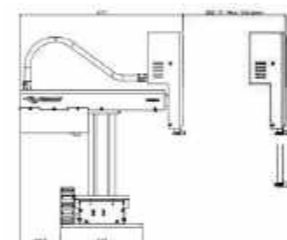

F6000 ADVANCE Series Gantry Robots

The F6000 ADVANCE gantry robotic systems can be easily integrated with in-line industrial automation. Gantry industrial robots have all their axes above the work area making them ideal for large dispensing applications.

The modular connectivity design allows Fisnar CCD vision system, tip alignment, and height detect kits to be easily incorporated onto the robot for increased productivity and performance.

Programming and control can be carried out via teach pendant, RS232, or proprietary PC software (sold separately).



Models

Item Number	Description
F6603N ADVANCE-110	3-Axis Gantry Robot 600x600x150 mm Work Area
F6603N ADVANCE-220	3-Axis Gantry Robot 600x600x150 mm Work Area
F6123N ADVANCE-110	3-Axis Gantry Robot 800x1,200x150 mm Work Area
F6123N ADVANCE-220	3-Axis Gantry Robot 800x1,200x150 mm Work Area

Features

- Work area up to 800 x 1,200 mm
- Axis repeatability +/- 0.02 mm
- 20 kg Z-axis payload
- Z-axis motor brake mechanism
- Dual linear guide and ball screw mechanism
- AC servo motor drive system with closed loop encoder feedback
- Modular connectivity interface

Benefits

- Open access design for easy integration into conveyor-fed/inline automation lines
- Automating dispense applications on oversize and heavy components is possible due to unlimited workload
- Optional CCD camera vision system can be easily installed for easier programming & more precise dispense results
- Heavy duty rigid frame structure for use in industrious environments

F6000 ADVANCE Series Gantry Robots

Specifications

Item Number	F6603N ADVANCE-110	F6123N ADVANCE-110
	F6603N ADVANCE-220	F6123N ADVANCE-220
Maximum Working Area (X/Y/Z)	600 x 600 x 150 mm (24 x 24 x 6")	800 x 1,200 x 150 mm (32 x 32 x 6")
Maximum Speed (X&Y/Z)	800 / 320 mm / secs	
Tool Load	20 kg (44 lb)	
Repeatability	+/- 0.02 mm	
Drive Mechanism	Dual Linear Guide / Ball Screw	
Drive System	AC Servo Motor	
Data Memory	1 - 100 programs 50,000 points / program	
I/O Signals	8 inputs / 8 outputs	
External Interface	USB / RS232	
Power Supply	110 - 130 VAC (F6603N-110 & F6123N-110) 220 - 240 VAC (F6603N-220 & F6123N-220)	
Dimensions (WxDxH)	1,220 x 957 x 682 mm (48 x 38 x 27")	1,420 x 1,557 x 682 mm (56 x 62 x 27")
Weight	117 kg (258 lb)	162 kg (378 lb)
Approvals	CE, RoHS, WEE	

F6603N ADVANCE

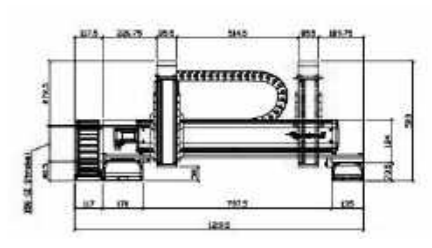
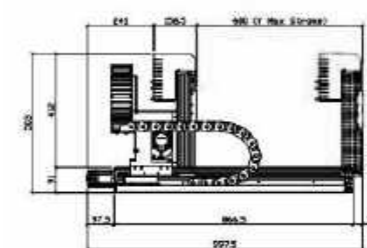
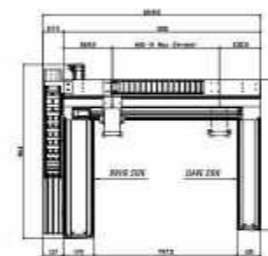

F6123N ADVANCE

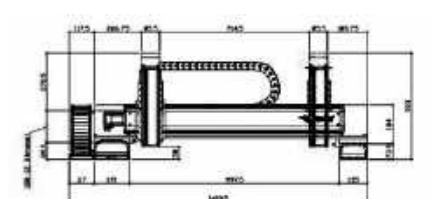
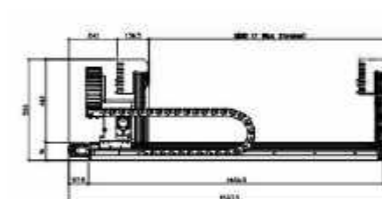
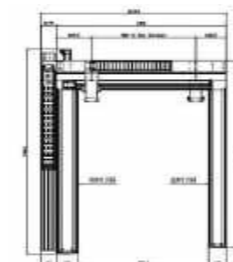

F8000 Series Gantry Robots

The F8000 series of robots are servo motor-driven, ball screw design, gantry robots. A heavy duty aluminum structure prevents flexing and vibration while maintaining functionality. Ideal for conveyor-fed applications.

Where applications require all moving axes to be above the workstation, the F8000 series provides the capability.



Custom robot sizes available upon request.

Features

- AC servo motors
- Available in three and four axis models
- Repeatability of 0.02 mm
- Highly rigid frame structure
- Open access design for in-line operation
- 100 programs on board

Specifications

Item Number	F8100N Series	F8800N Series
Working Area (X/Y/Z)	1,000 x 800 x 200 mm (+/- 360°)	800 x 600 x 200 mm (+/- 360°)
Maximum Tool Load (R)	5 kg (11 lb)	
Maximum Speed X&Y/Z	1,000 & 500 mm / secs (360°)	
Repeatability (R)	+/- 0.02 mm / axis (+/- 0.058 ³)	
Resolution (R)	0.001 mm (+/- 0.001°)	
Data Memory	100 programs / 20,000 steps / 20,000 points	
Drive System	AC servo motor	
Motion Control	PTP & CP	
System I/O, User I/O	24 inputs / 6 outputs, 32 inputs / 6 outputs	
Dimensions (WxDxH)	1,425 x 1,630 x 627 mm (56 x 64 x 25")	1,110 x 1,380 x 565 mm (44 x 54 x 22")
Weight	F8100N: 115 kg, F8104N: 124 kg (F8100N: 254 lb, F8104N: 273 lb)	F8800N: 72 kg, F8804N: 81 kg (F8800N: 159 lb, F8804N: 179 lb)

Models

Item Number	Description
F8100N	3-Axis Robot - 1,000x800x200 mm Work Area
F8104N	4-Axis Robot - 1,000x800x200 mm Work Area
F8800N	3-Axis Robot - 800x600x200 mm Work Area
F8804N	4-Axis Robot - 800x600x200 mm Work Area

F9000 Series Gantry Robots

The F9000 gantry robotic systems can be easily integrated with in-line industrial automation.

Gantry industrial robots have all their axes above the work area making them ideal for large dispensing applications and jobs requiring a fourth axis, such as when using a spray valve.

These robots can be manufactured to accommodate custom sizes up to 8 m x 6 m.



Custom robot sizes available upon request.

Features

- AC servo motors
- Available in three and four axis models
- Repeatability of 0.02 mm
- Highly rigid frame structure
- Open access design for in-line operation
- 100 programs on board

Specifications

Item Number	F9300N Series	F9600N Series	F9800N Series
Working Area (X/Y/Z)	300 x 300 x 200 mm (+/- 360°)	600 x 600 x 200 mm (+/- 360°)	800 x 600 x 200 mm (+/- 360°)
Maximum Speed X&Y/Z (R)	1,000 & 500 mm / secs (360°/secs)		
Maximum Tool Load (R)	7 kg (15 lb)		
Resolution (R)	0.001 mm (+/- 0.001°)		
Data Memory	100 programs / 20,000 steps / 20,000 points		
System I/O, User I/O	24 inputs / 6 outputs, 32 inputs / 32 outputs		
External Interface	USB / RS232		
Power Supply	220 - 240 VAC		
Dimensions (WxDxH)	679 x 696 x 505 mm (27 x 27 x 20")	979 x 1,022 x 505 mm (39 x 40 x 20")	1,179 x 1,022 x 505 mm (46 x 40 x 20")
Weight	29 kg (64 lb)	37 kg (81 lb)	43 kg (95 lb)

Models

Item Number	Description
F9300N	3-Axis Robot - 300x300x200 mm Work Area
F9304N	4-Axis Robot - 300x300x200 mm Work Area
F9600N	3-Axis Robot - 600x600x200 mm Work Area
F9604N	4-Axis Robot - 600x600x200 mm Work Area
F9800N	3-Axis Robot - 800x600x200 mm Work Area
F9804N	4-Axis Robot - 800x600x200 mm Work Area

CCD Camera Vision System

A powerful and intelligent CCD vision programming and auto adjustment system for creating both simple and complex dispense routines. This results in improved quality due to precise dispense positioning alongside improved production yield and reduced processing time and costs.

Dispense programs are created quickly and easily in the Fisnar proprietary vision-controlled Fluid-In-Motion (FIM) software by using the displayed camera image to jog the robot to the exact required dispense location, and then selecting the operation wished to be carried out (dispense dot, line start, etc).

Vision system software is supplied with an auto-part alignment function to guarantee fluid is being dispensed at the exact required location. This is achieved by the system capturing an image of two separate fiducial locations on the component and using pattern recognition software to compare the live image against a stored image. Any difference found in X or Y position results in the dispense coordinates being automatically adjusted to suit.

Dispense positional accuracy and repeatability is further optimized by the simple auto-calibration routine and part alignment function.



Item Number

F4000AKIT-VISION

F6000AKIT-VISION

Features

- Auto 3-axis tip calibration function
- Auxillary camera to monitor dispense process live
- High resolution CCD camera
- LED Light & Brightness Controller
- Simple & fast transfer of CAD data (.DXF/Gerber) into software
- Quick set up, easy to program/operate using proprietary software
- Industrial Windows based PC system included
- Glue check/verification function*

Benefits

- Vision system can be easily installed at any time onto a F4000 or F6000 ADVANCE 3-axis robot
- Plug and play system design
- Peripheral hardware is mounted directly onto robot reducing space envelope taken up
- Images can be captured and stored for quality and process control purposes
- QR codes can be scanned by the camera, causing the relating program to be automatically selected

Proprietary User Interface

For simple user setup, programming, and operation.

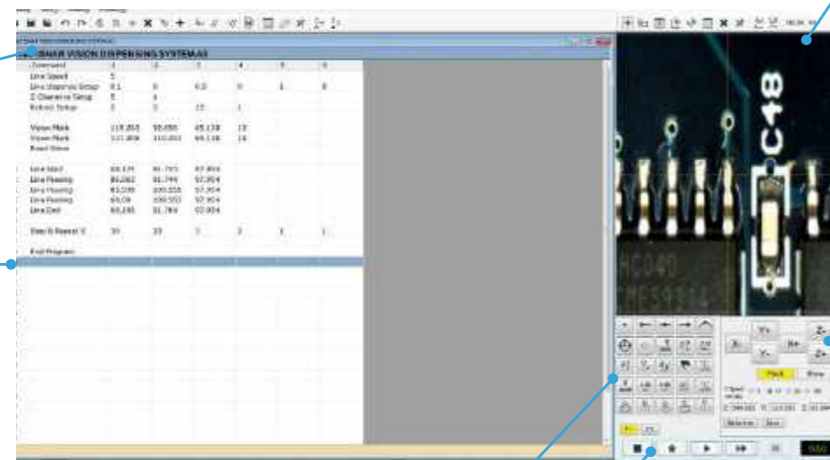

Tool Ribbon
Used for quickly accessing program setup and management functions.

Programming Window
Gives full and simple view of complete dispense program. Values can be edited directly by clicking on the line.

Camera Display
Real time view of camera viewing area. Cross hair designates dispense location to ensure precise positional control. Clicking on imaging area will jog robot to position clicked on.

Robot Movement
Icons used to control robot movement and speed while also displaying absolute/relative dispense coordinates.

Dispense Function
Graphical icons used for quick robot programming.

Robot Actuation
Icons used to start, stop, and view robot program.

*Glue check function not suitable for all applications. To be certified by Fisnar application team.

Vision System Kit Contents

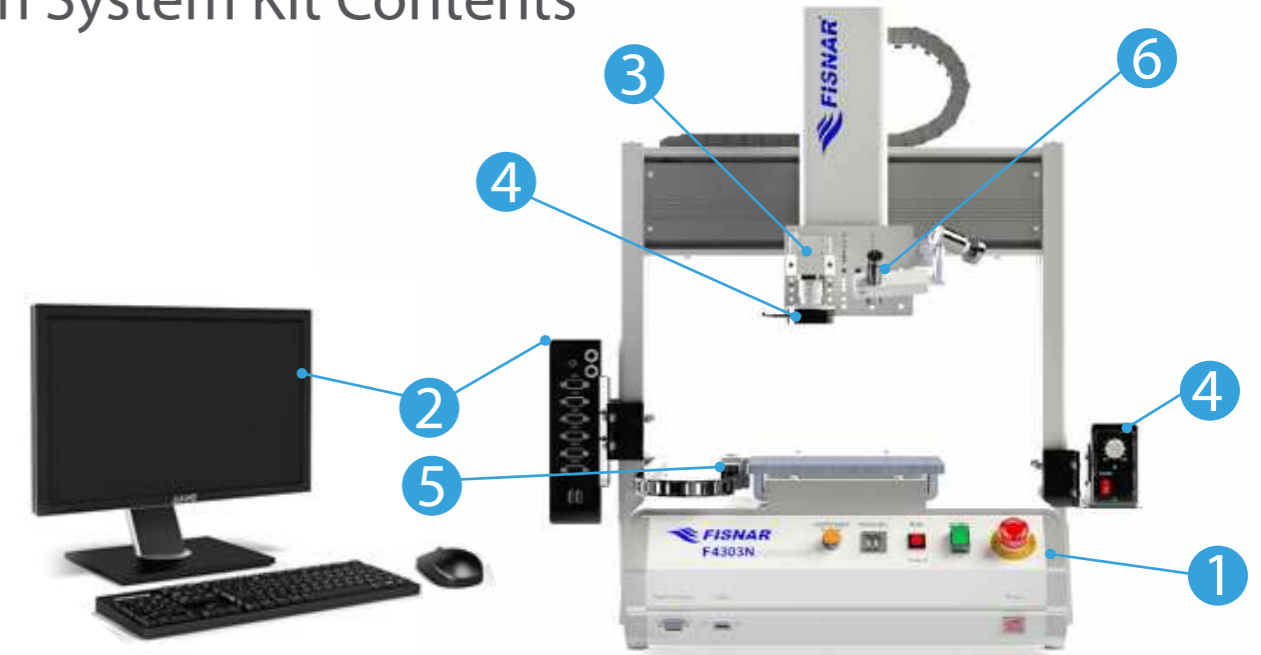

*Height sensor sold separately

1 F4000 ADVANCE Benchtop Robot

Highly robust and durable based on their cast aluminium base and heavy duty extruded aluminum twin vertical side pillars supporting the horizontal X-axis. This rigid design concept allows for long term precision dispensing and dependable repeatability.

2 PC

Industrial specification PC installed with Windows 7 and Fluid-In-Motion (FIM) software ready to use. Unit mounted directly onto robot to reduce overall space envelope. TFT LCD monitor, keyboard, and mouse included.

3 CCD Camera

For high resolution color and grayscale image capturing.

4 LED Ring Light & Controller

For optimizing image contrast and definition. Adjustable light brightness controller is mounted directly onto the robot to reduce the overall space envelope.

5 Tip Calibration Module

Works by the camera capturing an image of the purged fluid and uses pattern recognition to compare it against a pre-defined datum image. Any difference found between the center positions result in the X and Y coordinate values being automatically adjusted and dispense program re-aligning to suit. The Z-axis is automatically calibrated by the dispense tip contacting a touch pad.

6 Aux Camera

Displays a live image on the TFT LCD monitor allowing the user to clearly monitor the fluid being dispensed onto the component part while a dispense cycle is taking place.

Mechanical Tip Alignment

The TA360U-KIT is a mechanical tip adjustment kit allowing the mounting hardware attached to the robot to be mechanically adjusted in the X, Y, and Z axis.

The TA360U-KIT allows the dispense tip to be quickly and easily adjusted by re-aligning it to a known location of the robot program.

Re-alignment can be carried out remotely to the program and adjustments can be easily made by users not trained in robot programming.



Item Number

TA360U-KIT

Automatic Tip Alignment

A series of tip alignment modules designed for precise dispensing applications that require frequent material or tip changes, which could alter the position of the dispensing needle.

With the tip alignment module installed, the user can simply run a function on the robot that will automatically offset the program based on the new dispense tip position. This ensures consistent dispense results and minimal production downtime.

This functionality can also be run through an external control making it simple for use in a production environment.



Item Number	Description
TA4200N.2	Tip Alignment Module for F4200N.2 & F5000N.2 Robots
F4000AKIT-TA3	Tip Alignment Module for F4000 ADVANCE 3-Axis Robots
F4000AKIT-TA4	Tip Alignment Module for F4000 ADVANCE 4-Axis Robots
F6000AKIT-TA3	Tip Alignment Module for F6000 ADVANCE 3-Axis Robots
TA9000N	Tip Alignment Module for F8000 & F9000 3-Axis Robots

Auxiliary Rotation Axis

The Auxiliary Rotation Module allows an additional axis to be quickly and easily mounted onto a F4000 ADVANCE 3-axis robot. Mounting options:

Horizontal Mounting: When 4-axis (R) rotation is required but not possible due to size or weight of the dispense equipment that is normally attached to the robot Z-axis that typically rotates on a conventional 4-axis robot. With this configuration the workpiece rotates instead, achieving the same end result. Horizontal mounting allows the CCD vision system to be used in applications requiring 4-axis motion.

Vertical Mounting: For applications that require dispensing onto multiple planes on a single workpiece. Dispensing onto cylindrical components can be made easy with the device mounted in either a horizontal or vertical position depending on the specific application process.



Item Number

F4000AKIT-AUX

Height Sensor

The height sensor automatically adjusts the dispense tip height in the event of any variation of the height of workpiece being dispensed upon. Setup and programming of the height sensor is carried out by following a user friendly step-by-step procedure pre-installed onto the robot software.

By comparing the actual workpiece height against the original stored datum value in the robot program, any deviation found in the workpiece height results in the Z-axis coordinate data being automatically offset accordingly. Multiple height checks can be made within one robot program in the event of multiple workpieces being processed or a single workpiece with differing heights.



Item Number

F4000AKIT-HDS

F6000AKIT-HDS

I/O Expansion Module

The I/O expansion module increases the number of inputs and outputs while simplifying connection of external devices (e.g. sensors) to the robot.

The I/O expansion module increases the number of robot inputs to 16 channels and outputs to 20 channels. Two different models (NPN or PNP) are available depending on the I/O signal type of the external devices. The use of this device also prevents any damage caused to the PCB inside the robot due to incorrect wiring or failure of the external device.

Item Number	Description
F4000AKIT-IONPN	I/O Expansion Module - NPN Signal
F4000AKIT-IOPNP	I/O Expansion Module - PNP Signal



Remote Operation Box

The remote operation box allows users to operate the robot from a safe distance or in instances when the robot is housed within a safety enclosure.

A version is also available with a safety relay (Category 3, PL d) incorporated directly inside allowing a light curtain or safety switch to be easily connected to the control box. This eliminates the need for additional cost for an unnecessary electrical control panel to be fitted.

Item Number	Description
F4000AKIT-EXTBOX	Remote Operation Box
F4000AKIT-EXTBOX-SR	Remote Operation Box with Safety Relay



Robot Accessories Compatibility Chart

Robots	Accessories														
	F4000AKIT-VISION	F6000AKIT-VISION	TA360U-KIT	TA4200N.2	F4000AKIT-TA3	F4000AKIT-TA4	F6000AKIT-TA3	TA9000N	F4000AKIT-AUX	F4000AKIT-HDS	F6000AKIT-HDS	F4000AKIT-IONPN	F4000AKIT-IOPNP	F4000AKIT-EXTBOX	F4000AKIT-EXTBOX-SR
F1300N			•											•	•
F4200N.2			•	•								•	•	•	•
F5200N.2			•				•			•	•	•	•	•	•
F5300N.2			•				•			•	•	•	•	•	•
F4303N ADVANCE	•		•		•			•	•			•	•	•	•
F4403N ADVANCE	•		•		•			•	•			•	•	•	•
F4503N ADVANCE	•		•		•			•	•			•	•	•	•
F4603N ADVANCE	•		•		•			•	•			•	•	•	•
F4304N ADVANCE						•			•			•	•	•	•
F4404N ADVANCE						•			•			•	•	•	•
F4504N ADVANCE						•			•			•	•	•	•
F4604N ADVANCE						•			•			•	•	•	•
F4505N ADVANCE												•	•	•	•
F4553N ADVANCE			•		•							•	•	•	•
F4554N ADVANCE						•						•	•	•	•
F4303N ELITE												•	•	•	•
F4403N ELITE												•	•	•	•
F6603N ADVANCE		•	•				•			•	•	•	•	•	•
F6123N ADVANCE		•	•				•			•	•	•	•	•	•
F8000 SERIES								•							
F9000 SERIES								•							



Universal Robot Holder Assemblies

High quality valve and cartridge holder assemblies for use with Fisnar's line of robots and dispense systems.

Kitted for easy out-of-the-box, plug-and-play assembly, designed to create a smooth and convenient installation, removal, and setup experience.

Their unique design allows for valves to be quickly removed for maintenance requirements and then re-installed without losing the original datum mounting position.

The Z-axis mounting position can also be adjusted to reduce working movement to the workplace in order to reduce robot cycle times.

Suitable for use with the following platforms:

- F1300N Rotary Table
- F4000 Series Benchtop (3, 4, and 5-Axis)
- F5000 Series Benchtop (3-Axis)
- F6000 Series Gantry (3-Axis)
- F8000 Series Gantry (3-Axis)
- F9000 Series Gantry (3-Axis)



Universal Syringe, Valve & Cartridge Retainer Holders

560920U Universal Syringe Holder For use with 3, 5, 10, 30 & 55 cc syringes	562151U Universal Valve Holder For use with VP300, VD510 & SV2000N	562088U Universal Valve Holder For use with SV1000SS	5601801U Universal Valve Holder For use with VMP30H, PDV-1000, VMS400 & VDP150	5601800U Universal Holder For use with DTD50, PosiPump™, TS5000DMP, Pz1200 & MX150
560928U Universal Valve Holder For use with MV-0180LF	560927U Universal Valve Holder For use with 790HP-LF	561355U Universal Valve Holder For use with 710PT-U	562064U Universal Valve Holder For use with CV629	
560926-EU Cartridge Retainer Holder For use with 2.5, 6 & 12 oz EFD cartridge retainers	560926-NU Cartridge Retainer Holder For use with 2.5, 6, 8 & 12 oz nylon cartridge retainers	560926-TU Cartridge Retainer Holder For use with 2.5, 6, 8 & 12 oz metal cartridge retainers	561785U 1/10th Gallon Cartridge Retainer Holder For use with CR300	
562297-EU 20/32oz Cartridge Retainer Holder For use with 20/32 oz EFD cartridge retainers	562297-SU 20/32oz Cartridge Retainer Holder For use with 20/32 oz Semco cartridge retainers	562297-TU 20oz Cartridge Retainer Holder For use with CR570 & 101-20R cartridge retainers		

Modular Syringe & Valve Configurations



0401-08-000683 0401-08-000525 0401-08-000484 0401-08-000485 0401-08-000483



0401-08-000248

0401-08-000491

0401-08-000524

0401-08-000523

0401-08-000766 0401-08-000542

0401-08-001357

Modular Cartridge Retainer Configurations



0401-08-000487 0401-08-000488 0401-08-000486 0401-08-000489 0401-08-001550



0401-08-000490

0401-08-001408

0401-08-001586

Spare parts identifier guide located on pages 145 & 146.

4-Axis Universal Gantry Holder Assemblies

Holder assemblies for 4-axis gantry style robot platforms.

Allows for valves, syringes, and cartridge retainers to be mounted directly to the bracket and fixed at an angle from 0° to 90°.

High quality assemblies for use with Fisnar line of robots and dispense systems.

Kitted for easy out-of-the-box, plug-and-play assembly, designed to create a smooth and convenient installation, removal, and setup experience.

Their unique design allows for valves to be quickly removed for maintenance requirements then re-installed without losing the original datum mounting position.

The Z-axis mounting position can also be adjusted to reduce working movement to the workplace in order to minimize robot cycle times.

Suitable for use with the following platforms:

- F8000 Series Gantry (4-Axis)
- F9000 Series Gantry (4-Axis)



4-Axis Universal Syringe, Valve, & Cartridge Retainer Holders



562195BU
Gantry Syringe Holder 4-Axis



562195VU
Gantry Valve Holder 4-Axis
For use with VP300, SV2000N &
VD510 Series



562089U
Gantry Valve Holder 4-Axis
For use with SV1000SS



562220U
Gantry Valve Holder 4-Axis
For use with 790HP Series Valves



562158U
Gantry Valve Holder
For use with MV-0180 Valve



562050U
CR300 Cartridge Retainer
Holder



562055-TU
Metal Cartridge Retainer
Holder



562055-EU
EFD Cartridge Retainer
Holder



562055-NU
Nylon Cartridge Retainer
Holder

4-Axis Modular Syringe & Valve Configurations



0401-08-000485



0401-08-000483



0401-08-000246
Bushing included.



0401-08-000491 0401-08-000524 0401-08-000766 0401-08-001499 0401-08-000523 0401-08-000542

4-Axis Modular Cartridge Retainer Configurations



0401-08-000246
Bushing included.



0401-08-001550



0401-08-000489



0401-08-000488



0401-08-000487

Spare parts identifier guide located on pages 145 & 146.

Cartridge Retainer & Valve Backplate

Compatible with 3-axis robots and corresponding cartridge retainers. Ideal for feeding a valve from a prefilled cartridge system while optimizing fluid flow rate.

Suitable for use with the following platforms:

- F1300N Rotary Table
- F4000 Series Benchtop (3-Axis)
- F5000 Series Benchtop (3-Axis)
- F6000 Series Gantry (3-Axis)
- F8000 Series Gantry (3-Axis)
- F9000 Series Gantry (3-Axis)



Example configuration CR300 with 790HP-LF valve.

Syringe, Valve, & Cartridge Retainer Modular Configurations



Spare parts identifier guide located on pages 145 & 146.

Backplate Syringe & Valve Holder

Compatible with all 3-axis robots and corresponding cartridge retainers. Ideal for simultaneous dispensing from syringes, valves, and cartridges when increased productivity is required.

Suitable for use with the following platforms:

- F4000 Series Benchtop (3-Axis)
- F5000 Series Benchtop (3-Axis)



Example configuration dual syringe and light guide.



Example configuration 790HP valve and CR300 cartridge retainer.

Multi-Syringe, Valve, or Cartridge Retainer Modular Backplate Configurations





















Spare parts identifier guide located on pages 145 & 146.

Spare Parts

Item Number	Description
 0401-08-000483	Sliding Bracket Holder
 0401-08-000683	3-Axis Square Sliding Plate Holder
 0401-08-000484	3-Axis Sliding Plate Holder
 0401-08-000525	3-Axis Square Sliding Plate Holder
 0401-08-000485	4-Axis Angled Sliding Plate Holder
 0401-08-000491	Universal Valve Holder - For use with VP300, VD510 & SV2000N Series Valves
 0401-08-000523	Universal Valve Holder For use with MV-0180LF Valve
 0401-08-001499	Syringe Holder Bottom Plate For use with 3, 5, 10, 30 & 55 cc syringes
 0401-08-000524	Universal Valve Holder For use with 790HP-LF Valve
 0401-08-000766	Universal Valve Holder For use with SV1000SS Valve
 0401-08-000542	Universal Valve Holder For use with CV629 Valve
 0401-08-001357	Universal 710PT-U Valve Holder
 0401-08-000246	4-Axis Gantry Mounting Bracket
 0401-08-000486	3-Axis Cartridge Retainer Holder
 0401-08-000488	Cartridge Retainer Holder 2.5, 6, 8 & 12 oz Metal
 0401-08-000489	Universal Cartridge Retainer Holder 2.5, 6 & 12 oz EFD Retainers
0401-08-001550	Nylon Cartridge Retainer Holder 2.5, 6 & 12 oz

Spare Parts

Item Number	Description
 0401-08-001408	Universal Cartridge Retainer Holder for use with 20 & 32 oz EFD Retainers
 0401-08-000490	Universal Cartridge Retainer Holder for use with 20 oz CR570/101-20R Metal Retainers
 0401-08-001586	Universal Cartridge Retainer Holder for use with 20 & 32 oz Semco Retainers
 0401-08-000487	Cartridge Retainer Holder CR300 (1/10th Gallon)
 0401-08-000775	UV Light Guide Holder BlueWave® Light Guide 10 mm, End of Wand
 0401-08-001630	UV Light Guide Holder for QX4 Light Guide
 0401-08-000249	3-Axis Backplate Holder
 0401-08-000543	Multi-Syringe, Valve & Cartridge Retainer Backplate
 0401-08-000777	Gantry Robot Holder Plate
 0401-08-000769	Benchtop Robot Spacer Bracket
 0401-08-000250	Adapter Nut Holder
 0401-08-001629	Sleeve Bushing for RobotKit-EADP400-85MLTPU
 0401-08-001707	Sleeve Bushing for RobotKit-300PBMLTPU
 0401-08-001708	Sleeve Bushing for RobotKit-EADP200-70MLTPU
 0401-08-001698	Mixer Sleeve Bushing Holder
 0401-08-001699	Mixer Sleeve Bushing - 8 mm
 0401-08-001700	Mixer Sleeve Bushing - 10 mm
 0401-08-001701	Mixer Sleeve Bushing - Blank
 0401-08-001692	Syringe Holder Bushing - 3 cc
 0401-08-001693	Syringe Holder Bushing - 5 cc
 0401-08-001694	Syringe Holder Bushing - 10 cc

Valve Bracket Holder & Stand Compatibility Chart

Valves	F4000, F5000 & F6000 Series Robots		F8000 & F9000 Series Robots		Rotary Table	Stands
	3 & 5-Axis	4-Axis	3-Axis	4-Axis	F1300N	Workbench
790HP-LF	560927U	560927U	560927U	562220U	560927U	560671U
790HPSS-LF	560927U	560927U	560927U	562220U	560927U	560671U
VD510	562151U	562151U	562151U	562195VU	562151U	562143U
VD510-UV	562151U	562151U	562151U	562195VU	562151U	562143U
VD510-SS	562151U	562151U	562151U	562195VU	562151U	562143U
MV-0180LF	560928U	560928U	560928U	562158U	560928U	560536U
MV-0180SS	560928U	560928U	560928U	562158U	560928U	560536U
CV629	562064U	562064U	562064U	-	562064U	562166U
SV2000N	562151U	562151U	562151U	562195VU	562151U	562054U
SV1000SS	562088U	562088U	562088U	562089U	562088U	562054U
710PT-U	561355U	561355U	561355U	-	561355U	562054U
PDV-1000	5601801U	5601801U	5601801U	-	5601801U	562235U
VMS400	5601801U	5601801U	5601801U	-	5601801U	562235U
VMP30H	5601801U	5601801U	5601801U	-	5601801U	562235U
VP300	562151U	562151U	562151U	562195VU	562151U	562143U
VDP150	5601801U	5601801U	5601801U	-	5601801U	562235U
PosiPump™ I-Series	5601800U	5601800U	5601800U	-	5601800U	562318U
PosiPump™ V-Series	5601800U	5601800U	5601800U	-	5601800U	562318U
Pz1200	5601800U	5601800U	5601800U	-	5601800U	562318U

Cartridge Retainer/Syringe Bracket Holder & Stand Compatibility Chart

Syringe/Retainer	F4000, F5000 & F6000 Series Robots		F8000 & F9000 Series Robots		Rotary Table	Stands
	3 & 5-Axis	4-Axis	3-Axis	4-Axis	F1300N	Workbench
Syringe Holder 3, 5, 10, 30/55 cc	560920U	560920U	560920U	562195BU	560920U	560021U
Cartridge Holder 2.5, 6, 8, 12 oz E-Type	560926-EU	560926-EU	560926-EU	562055-EU	560926-EU	-
Cartridge Holder 2.5, 6, 8, 12 oz T-Type	560926-TU	560926-TU	560926-TU	562055-TU	560926-TU	560535U
Cartridge Holder 2.5, 6, 8, 12 oz N-Type	560926-NU	560926-NU	560926-NU	-	560926-NU	560535-NU
Cartridge Holder 1/10th Gallon	561785U	561785U	561785U	562050U	561785U	560549U
Cartridge Holder 20/32 oz E-Type	562297-EU	562297-EU	562297-EU	-	562297-EU	-
Cartridge Holder 20 oz T-Type	562297-TU	562297-TU	562297-TU	-	562297-TU	560534U
Cartridge Holder 20/32 oz S-Type	562297-SU	562297-SU	562297-SU	-	562297-SU	-

Robot Kits

A range of pre-packaged robot kits specially designed to accommodate the most popular dispense applications. Each kit contains the dispense hardware that a user requires to connect to a Fisnar dispensing robot or dispense controller.



Robot Kit 6OZNU

Contains all required bracket components for mounting a 6 oz nylon cartridge retainer to 3, 4, and 5-axis benchtop robots in order to directly dispense fluid material from the cartridge.

Includes:

- 6 oz Nylon Cartridge Retainer
- All additional required dispense accessories

Item Number

ROBOTKIT-6OZNU

Robot Kit 6OZTU

Contains all required bracket components for mounting a 6 oz Techcon cartridge retainer to 3, 4, and 5-axis benchtop robots in order to directly dispense fluid material from the cartridge.

Includes:

- 6 oz Techcon Cartridge
- All additional required dispense accessories

Item Number

ROBOTKIT-6OZTU

Robot Kit 300MLU

Contains all required bracket components for mounting a CR300 cartridge retainer to 3, 4, and 5-axis benchtop robots in order to directly dispense fluid material from 1/10th gallon (300 ml) cartridges.

Includes:

- CR300 Cartridge Retainer
- All additional required dispense accessories

Item Number

ROBOTKIT-300MLU



Robot Kit CAU

Contains all required bracket components for mounting a VD510 diaphragm valve to 3, 4, and 5-axis benchtop robot for the dispensing of cyanoacrylate fluid materials. The system ensures cyanoacrylate fluid materials are pressurized and fed to the valve in a safe and controlled manner.

Includes:

- VD510
- IJ2601N-SS-SP
- All additional required dispense accessories



Item Number

ROBOTKIT-CAU

Robot Kit 300+790U

Contains all required bracket components for mounting both a CR300 cartridge retainer and a 790HP-LF high-pressure spool valve to 3-axis benchtop robot.

Reduces material flow path length from fluid material cartridge to dispense valve, resulting in optimized fluid flow rate.

Includes:

- CR300 Cartridge Retainer
- Pressure regulator assembly for controlling fluid pressure inside CR300 Cartridge Retainer
- 790HP-LF high pressure spool valve
- All additional required dispense accessories



Item Number

ROBOTKIT-300+790U

Twin-Pack Robot Kits

The Fisnar line of twin-pack robot kits are specifically designed to accommodate 50, 200, and/or 400 ml cartridges from a variety of manufacturers for use with the Fisnar line of 3-axis benchtop robots. Designed to hold and dispense cartridge systems. Setup can be used with or without a pinch tube valve for more precise material shut off for thinner materials.

Robot kits suit the following Fisnar robots:

- | | |
|----------------------|----------------------|
| • F4303N ADVANCE | • F6123N ADVANCE-110 |
| • F4403N ADVANCE | • F6123N ADVANCE-220 |
| • F4503N ADVANCE | • F8100N |
| • F4553N ADVANCE | • F8800N |
| • F4603N ADVANCE | • F9300N |
| • F6603N ADVANCE-110 | • F9600N |
| • F6603N ADVANCE-220 | • F9800N |

Kits come complete with the following accessories to begin production testing:

- DCK800 Dispense Needle Selection Kit
- Luer Lock Adapters
- Sample Mix Nozzles for each size kit
- Pinch Tube Samples
- Air Input Line with 1/4" NPT Fitting
- P.E. Tubing 1/4" x 0.170" - Natural 40" long
- Air Line Block Assembly

Robot Kit 400 ml

400 ml (200 ml/200 ml) twin pack cartridge kit dispenser with 710PT-U valve for all 3-axis robots. Contains Sulzer pneumatic dispenser suitable for most low to medium viscosities. Compatible with most F-style and C-style Sulzer 400 ml dual cartridges. Ready to use out of the box for 1:1 and 2:1 mix ratios, conversion kits included to adapt to 4:1 and 10:1.

Item Number

ROBOTKIT-EADP400-85MLTPU



Robot Kits - Other Available Models

Robot Kit 50 ml

50 ml (25 ml/25 ml) twin pack cartridge kit with 710PT-U valve for all 3-axis robots. Contains 50 ml pneumatic dispenser suitable for most low to medium viscosities. Compatible with most A-style and B-style Sulzer dual cartridges. Ready-to-use out of the box for 1:1 and 2:1 mix ratios, pistons included to convert to 4:1 and 10:1.



Item Number

ROBOTKIT-50MLTPU

Robot Kit 200 ml

200 ml (100 ml/100 ml) twin pack cartridge kit with 710PT-U valve for all 3-axis robots. Contains Sulzer pneumatic dispenser suitable for most low to medium viscosities. Compatible with most F-style and C-style Sulzer 200 ml dual cartridges. Ready-to-use out of the box for 1:1 and 2:1 mix ratios, conversion kits included to adapt to 4:1 and 10:1.

Item Number

ROBOTKIT-EADP200-70MLTPU

Robot Kit 600 ml

600 ml (300 ml/300 ml) twin pack cartridge kit with 710PT-U valve for all 3-axis robots. Contains Sulzer pneumatic dispenser suitable for low to high viscosities. Compatible with most Plas-Pak style dual cartridges. 1:1 for 300 ml x 300 ml, 2:1 for 300 ml x 150 ml, and 4:1 for 300 ml x 75 ml.

Item Number

ROBOTKIT-300PBMLTPU

Robot Kit 400 ml

400 ml (200 ml/200 ml) twin pack cartridge kit with 710PT-U valve for all 3-axis robots. Contains Sulzer pneumatic dispenser with larger air cylinder for thicker, high viscosity materials requiring more thrust. Compatible with most F-style and C-style Sulzer 400 ml dual cartridges. Ready-to-use out of the box for 1:1 and 2:1 mix ratios, conversion kits included to adapt to 4:1 and 10:1.

Item Number

ROBOTKIT-EADP400-100MLTPU



Notes

Notes



About Us

Fisnar® is a leading manufacturer and supplier of precision fluid dispensing and handling solutions.

With over 45 years of knowledge of the dispense industry and its global requirements, we have an accomplished range of dispensing products including robots, valves, dispensers, and a complete selection of consumables.

Armed with technical expertise and a diverse portfolio of dispensing products, Fisnar® can supply a system to suit every budget, application, and industry.

Visit our website: www.fisnar.com.

Contact Us

USA

info@fisnar.com
1 (262) 253-8600

Europe

infoeurope@fisnar.com
+44 (0) 1355 577222

Asia

info@fisnar.com.hk
+852 2389-2827

India

info@fisnar.in
+91-11-4556-6223-5





www.fisnar.com