

# New Products

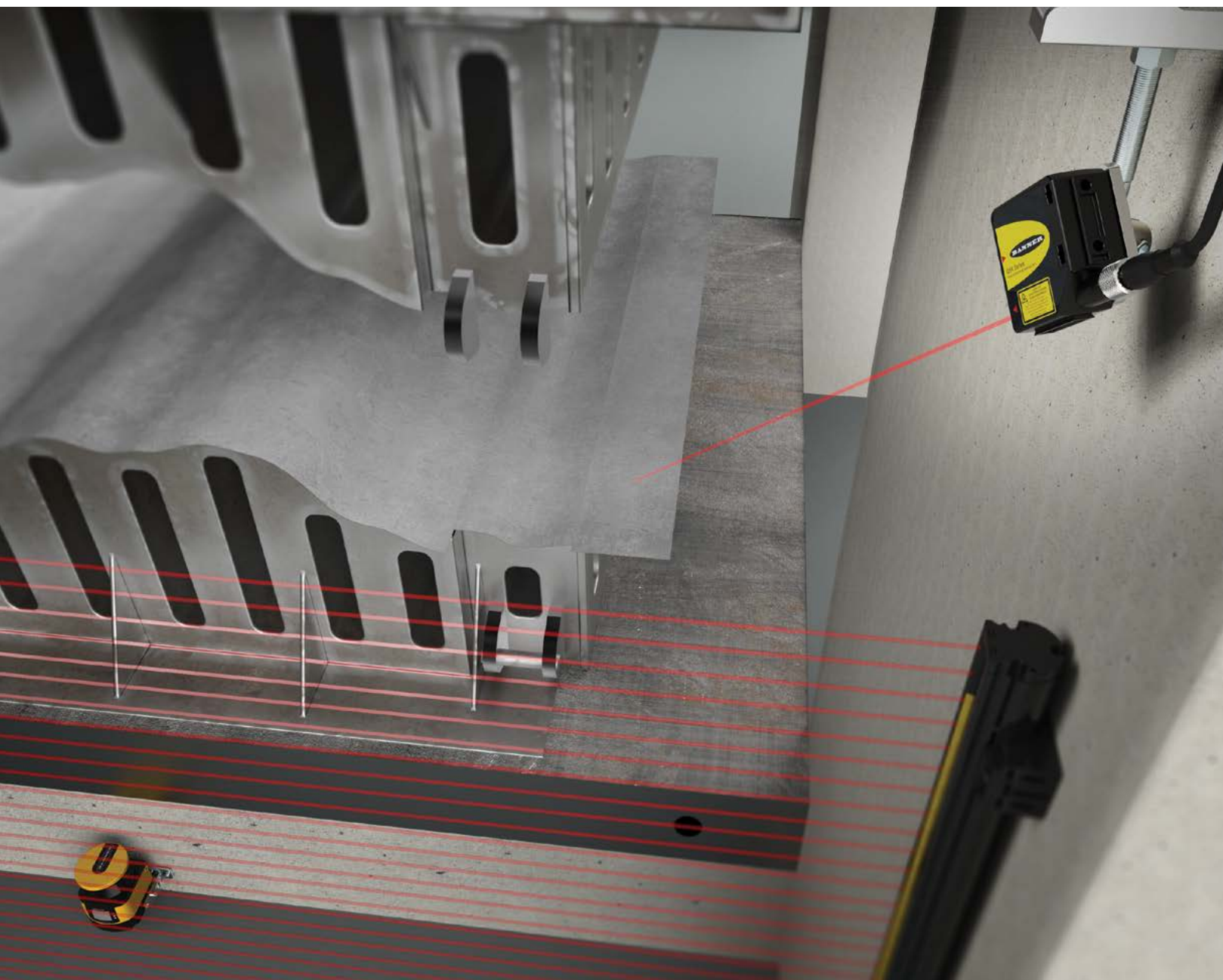

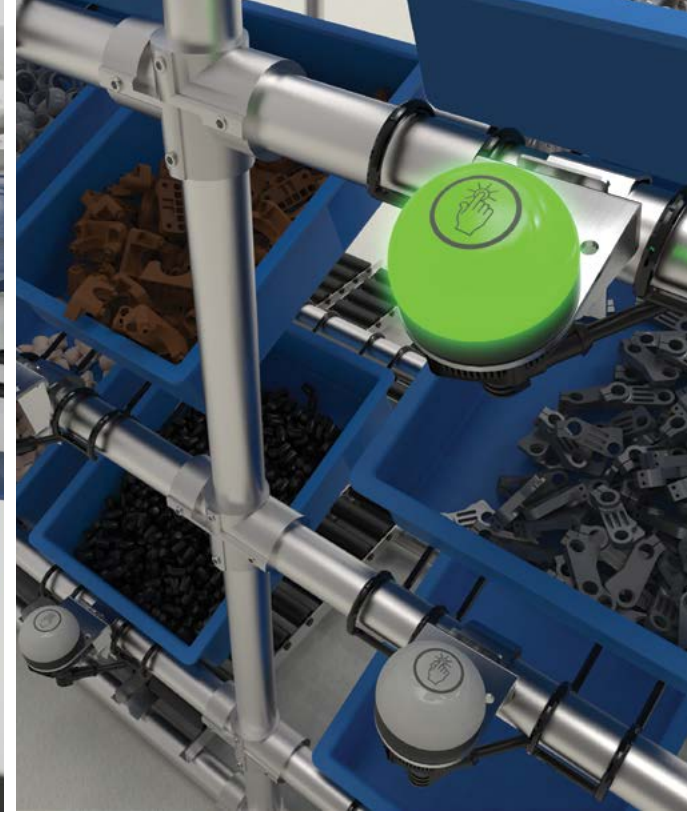

## Table of Contents

Q2X Series Miniature Photoelectric Sensors .....	6
Q20-2 Compact Sensors.....	7
Q5X Series High Power, Multi-Purpose Sensors.....	8
Q5Z Series High Power, Multi-Purpose Sensors.....	8
T30R Series Radar Sensors.....	10
K50R Series Radar Sensors .....	11
ZMX Series 3D Time of Flight Sensors.....	12
SC10 Series Compact Safety Controllers with ISD.....	18
XS26-ISDd Series Expandable Safety Controllers with ISD .....	19
SI-RF Series RFID Safety Switches with ISD.....	20
S4B Series Heavy-Duty Type 4 Safety Light Curtains.....	21
Illuminated E-Stops with ISD.....	22
SI-GL42 Series Safety Locking Switches.....	23
SX5 Series Safety Laser Scanners.....	24
Pro Lighting and Indication Products.....	30
Hazardous Location Lighting .....	32
WLA-2 Series Industrial LED Area Lights .....	33
TL15 In-Line Tower Light Indicators.....	34
K30 Pro Optical Sensors.....	35
K50 Pro Touch Indicators with Display.....	36
K50 Pro Touch Buttons with Audible.....	37
K50 Pro Indicator with Audible.....	38
CL50 Pro Column Lights.....	39
TLF100 Pro Flush Mount Tower Lights .....	40
K100 Pro Beacons.....	41
Snap Signal IIoT Hardware.....	44
DXMR90 Industrial Controllers .....	44
R45C IO-Link Masters.....	47
R90C IO-Link Masters.....	47
S15S Temperature Sensors.....	47
S15S Temperature and Humidity Sensors.....	47
S15C Converters.....	48
R95C Discrete Bimodal to Modbus Hubs.....	48
R90C Modbus to Analog Hubs .....	48
IO-Link Hardware .....	49
DXMR110-8K IO-Link Masters .....	50
DXMR90-4K IO-Link Masters with Ethernet.....	51
R95C IO-Link Hubs.....	52
R90C IO-Link Hubs.....	52
R45C IO-Link to Dual Analog Input-Output Converters .....	53
R70 Series Data Radios .....	54
Banner Cloud ID™ Kits.....	56
Q45 Series Wireless Sensors .....	56
R95 and R50 Molded Junction Blocks .....	60
S15L In-Line Sensor Status Indicators.....	61
S15A Wiring Adapters .....	61
CSB Splitters.....	61
S15Y Splitters.....	61

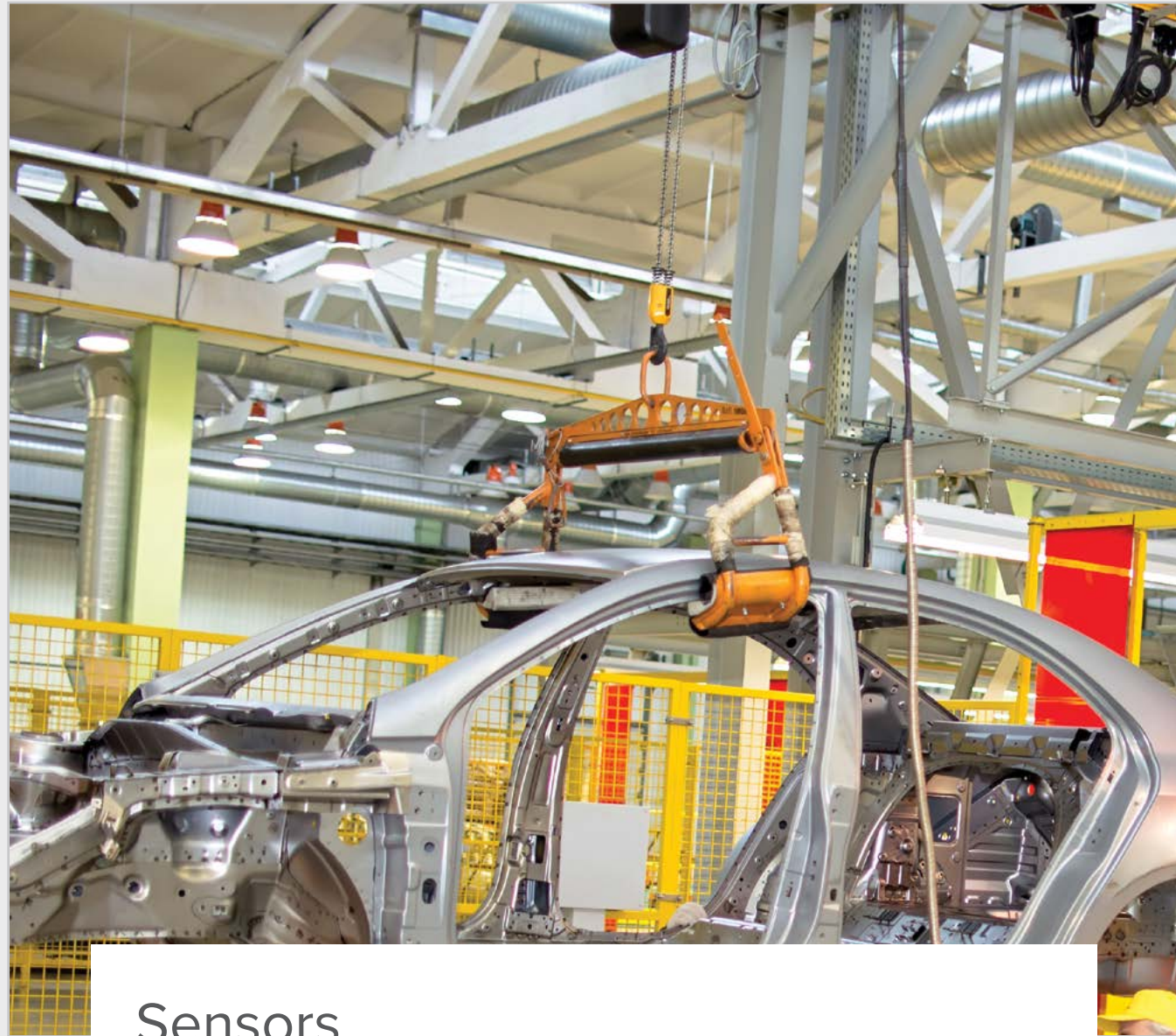

## Sensors

Banner Engineering has a wide variety of innovative sensors that excel in the most challenging industrial applications. These new devices can be used for clear object detection, distance measurement, object presence or absence, temperature and vibration detection, pick-to-light, and ultrasonic sensing.

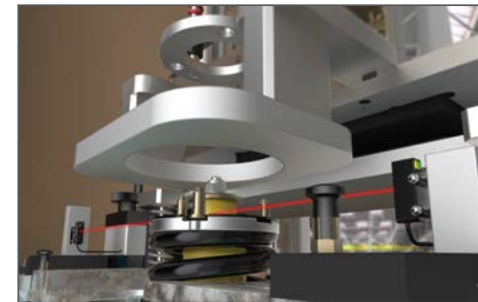

### Q2X Series Miniature Photoelectric Sensors

Powerful and simple sensing in a miniature package makes the Q2X ideal for installation in very precise machinery and tight industrial spaces.

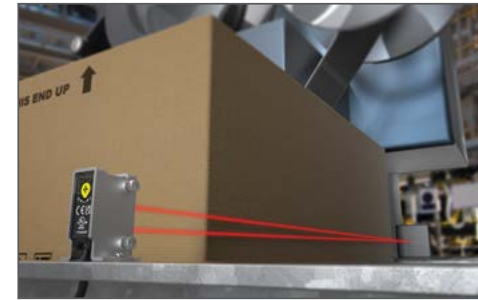

### Q20-2 Series Compact Sensors

Polarized retroreflective photoelectric sensors with a universal rectangular housing ideal for global manufacturing with best-in-class optical to mechanical alignment.

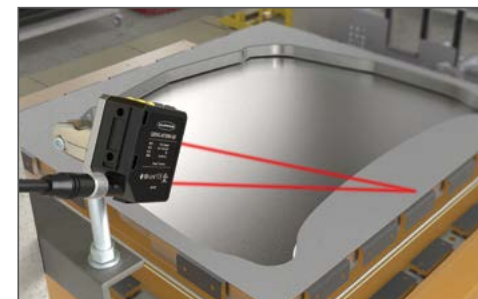

### Q5X Series High Power, Multi-Purpose Sensors

This powerful laser distance sensor covering a range from 50 mm to 10 m is easy to use and offers exceptionally reliable detection of the most challenging targets.

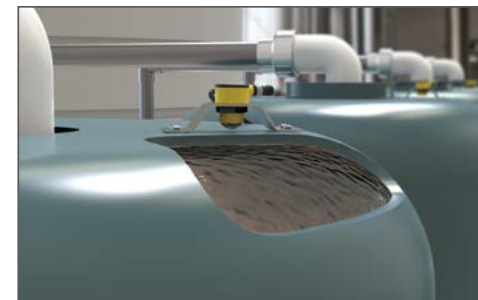

### T30R Series Radar Sensors

The T30R is a long-range sensor that provides reliable detection and position feedback even outdoors in extreme weather conditions.



### K50R Series Radar Sensors

The K50R series of radar sensors provides a durable, cost-effective solution for short-range detection applications, particularly in challenging environments.



### ZMX Series 3D Time of Flight Sensors

The ZMX Series 3D Time of Flight Sensor measures and monitors a three-dimensional area. It provides a single-sensor solution for filling applications by measuring both the peak height and average fill volume.





## Q2X Series Miniature Photoelectric Sensors

The next generation sensor for powerful and simple sensing in a small package.

- Miniature sensor for installation in the smallest of spaces
- Precise and reliable position detection of small components
- Machine design flexibility with proven mounting and connection options
- Small visible red LED or Class 1 laser emitter spot
- Enhanced immunity to fluorescent lights
- Crosstalk immunity algorithm allows two sensors to be used in close proximity (adjustable-field models only)
- For model information see page 62



## Q20-2 Series Compact Sensors

Universal rectangular housing ideal for global manufacturing with best-in-class optical to mechanical alignment.

- Polarized retroreflective photoelectric sensor in a compact, rugged, sealed plastic housing
- Best-in-class optical-to-mechanical alignment for consistent mounting, with visible red LED emitter for simple and precise alignment
- Extended 5000 mm (196.9 in.) sensing range, independent of object color
- Standard 3 mm threaded mounting holes on 25.4 mm (1 in.) spacing
- Polarized retroreflective models are ideal for detecting dark and shiny targets
- Features a single-turn gain potentiometer and a LO/DO switch
- For model information see page 62

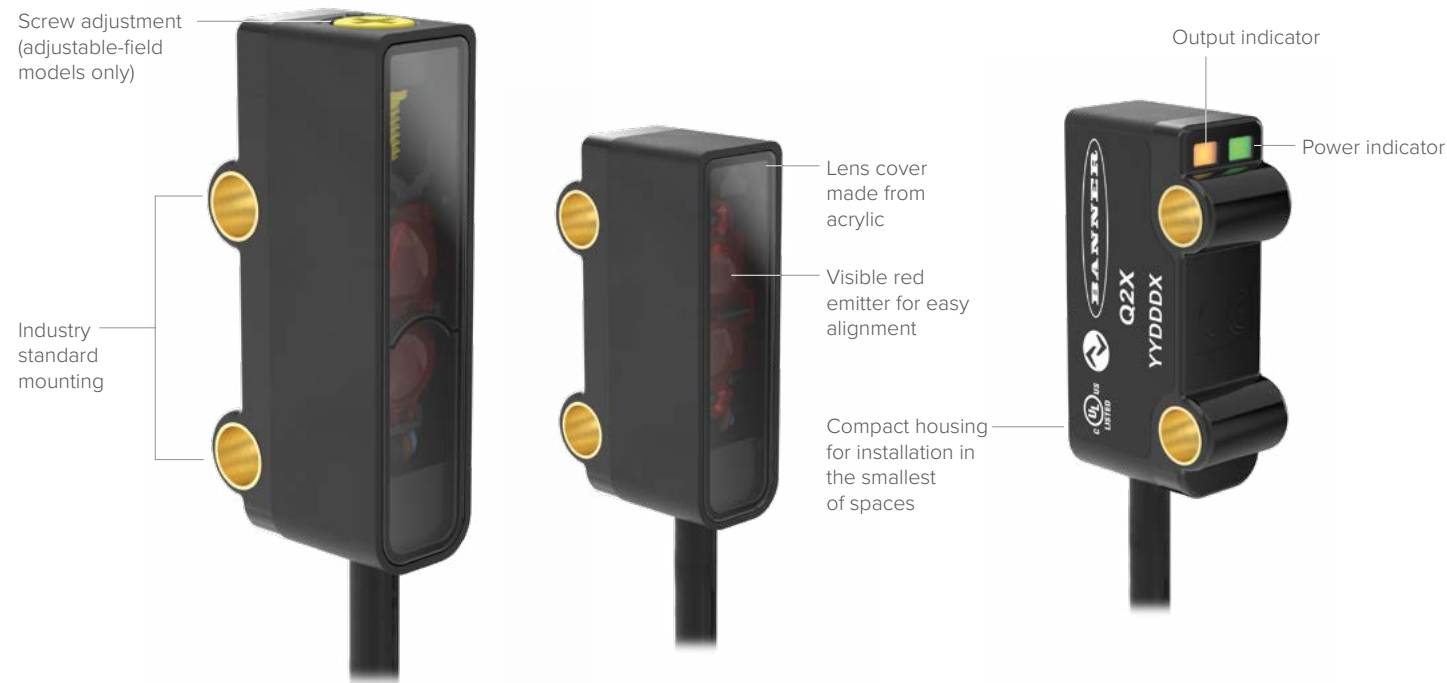

### Polarized Retroreflective

- Bright, visible red LED for easy alignment of sensor
- Works with a variety of reflectors
- Ideal for detecting dark and shiny targets

### Opposed

- Visible red LED with large spot size for easy alignment
- High switching frequency for reliable detection in high-speed applications

### Adjustable-Field

- Small, visible red LED or Class 1 laser emitter spot
- Simple multi-turn screw adjustment of cutoff distance
- Reliable detection of objects when the background condition is not controlled or fixed
- Crosstalk immunity algorithm allows two sensors to be used in close proximity

### Compact Sensor with Precision Alignment

#### Simplifies Machine Design

- Best-in-class boresighting ensures the beam spot hits exactly where it's expected
- Compact rectangular housing with 25.4 mm (1 in.) mounting-hole spacing

#### Fast Installation

- The small, bright spot makes it easy to align with the reflector
- Power is only needed on one side of the machine

#### Reduces Maintenance Costs

- Quickly replace an existing sensor with minimal time or effort
- Adjustments can be made with an onboard potentiometer and an LO/DO switch



## Q5X Series High Power, Multi-Purpose Sensors

This powerful background-suppression laser features a range from 50 mm to 10 m, is easy to use, and reliably detects the most challenging targets.

- Extremely high excess gain to detect the darkest and most difficult targets even at extreme angles
- Reliable detection of black, clear, reflective, multicolor, or textured targets in front of white or shiny metal backgrounds
- Jam detection model uses time and distance intelligence to alert operators to unwanted stoppage on conveyors and production lines
- Models with discrete, analog, and IO-Link communication are available
- For model information see page 62

- Four-digit display and three-button interface for easy setup and adjustment
- Distance to target viewable as centimeters (default) or inches



Rated IP67 for reliable performance in wet environments

Class 2 laser with small, highly visible spot for easy alignment and small object detection

### Q5Z Models

- Preconfigured at the factory for simple plug-and-play integration
- Teach with simplified single-button interface with feedback from bright indicators
- Durable and reliable design easily integrates into machines
- High excess gain to detect black rubber, shiny metal, and other hard-to-detect objects
- Visible red Class 2 laser with small spot for easy alignment



### Jam Detection Modes

The Q5X Jam Detection sensor can detect jams faster and more accurately, because it does not rely on gaps. Instead, looks for a change in signal strength and distance from the packages. The sensor can easily detect when packages are freely flowing, and if the line becomes jammed, the Q5X immediately alerts the operator. This reduces false positives and excessive delays, while also allowing for increased line speeds and throughput.

### Reliably Detects Challenging Targets

Dynamically adjusted laser power increases output for dark targets or objects at steep or uneven angles, while reducing power for shiny targets. A small beam spot minimizes measurement variation across color transitions.

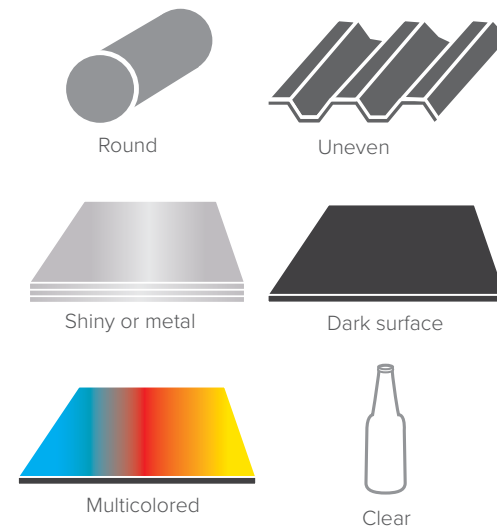

### Automotive Seat Inspection

#### Challenge

In automotive quality inspections, verifying the presence of dark parts against an equally dark background is extremely common. For example, many car seats consist of black fabric or leather material with black plastic components, such as levers and buttons to adjust seat height and tilt.

#### Solution

Banner's Q5X problem-solving triangulation-based laser sensor has no difficulty detecting dark targets on dark backgrounds when there is a height difference. The exceptionally high excess gain enables the Q5X sensor to reliably detect even the darkest objects (<6% reflective black targets) even against a dark background at all distances from 95 mm to 3 m.

### Detecting Dark Tires on Conveyor Belts

#### Challenge

A tire manufacturer would like to add sensors to the end of a conveyor production line so that finished tires are accurately stacked on shipping carts. A method is needed to reliably detect dark rubber tires on a dark conveyor belt, so that an automated system can pick them up and place them on the carts.

#### Solution

The preconfigured Q5Z Global Laser Measurement Sensor with IO-Link can be installed at the end of the conveyor for leading edge detection of tires as they approach. Q5Z sensors feature high excess gain to detect a wide variety of targets of any shape, color, or reflectivity, and its emitted laser can easily differentiate dark rubber from conveyor belts, without the need for a reflector. Because the sensor can be taught to measure targets at specific set points, it can detect tires at precise distances and ignore other objects on parallel conveyors. With this configuration, the automated process detects the finished tires, picks them up, and places them on carts for shipping, with the correct timing.





## T30R Series Radar Sensors

### Robust Detection in Challenging Environments

The T30R is a radar sensor that provides reliable detection and position feedback in challenging applications and extreme environments.

- Reliable detection of high-dielectric targets (like metal and large amounts of water) and lower-dielectric materials (such as wood, rock, and organic material) in a wide range of applications
- Virtually unaffected by rain, wind, snow, fog, steam, and sunlight
- Operating temperature of -40 to 65° C
- Radar configuration software, IO-Link, remote teach input, and push buttons for flexible setup and configuration
- T30RW models have a heavy-duty IP69K-rated housing with a polypropylene sleeve over the barrel for particularly harsh environments
- For model information see page 63



## K50R Series

### All-in-One Radar Sensor

The K50R series of radar sensors provides a durable, cost-effective solution for short-range detection applications, particularly in challenging environments.

- For detection and measurement of moving and stationary targets
- Large field of view offers powerful alternative to ultrasonic or photoelectric sensors
- Detect a wide variety of materials, indoors and outdoors
- Bright, visible indication; available in Pro models with configurable LEDs
- Easy setup and configuration of range, sensitivity, and output using the Banner Radar Configuration Software
- Compact, rugged IP67-rated housing withstands harsh environments
- Performance Modes to customize the sensor to the application
- For model information see page 63

### Robust, Longer-Range Alternative to Ultrasonics



- Ideal for outdoor applications**
- Resistant to rain, snow, fog, steam, or sunlight
  - IP67-rated

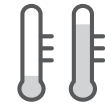

- Temperature stability**
- Radar (radio waves) not affected by temperature changes like ultrasonic (sound waves)
  - Consistent measurement from -40 to 65 °C

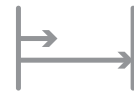

- Detect near or far**
- Sensing ranges down to 100 mm and up to 25 m

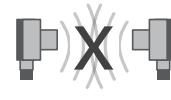

- No crosstalk**
- No problem mounting multiple sensors close together

### All-in-One Sensor



- Accurate measurement**
- Short dead zone of 0.1 m
  - 3 m range



- Ideal for outdoor applications**
- Resistant to rain, snow, fog, steam, and sunlight
  - IP67-rated
  - Consistent measurement from -40 to 60 °C



- Senses more objects**
- 60 GHz radar detects a wider range of low-dielectric materials for use in many applications



- Solve more problems**
- Dual discrete outputs for slow and stop
  - Pulse Pro for measurement values
  - K50R Pro with programmable LED indication



- Direct integration with Banner lights**
- No separate controller needed

### More Precise and Reliable Alternative to Traditional 24 GHz Radar



- Accurate measurement**
- Linearity and repeatability less than 1 cm



- Senses more objects**
- 122 GHz radar detects a wider range of low-dielectric materials for use in many applications

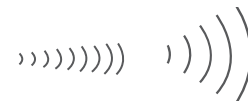

- Precise measurement up to 25 meters**
- Sensors use two independent, adjustable sensing zones and operate at 122 GHz, which enables higher-precision measurements with a narrow or wide beam pattern up to 25 meters away

### Bridging the Gap Between Ultrasonics and Radar



	Range	Dead Zone	Outdoor Durability	Measurement Precision	Crosstalk Immunity
Other Banner Radar (24 GHz)	✓		✓		✓
T30R (122 GHz)	✓	✓	✓	✓	✓
Ultrasonics		✓		✓	

### Operating Frequency

Different radar frequencies affect not only the range of the sensor, but also what materials it can detect. 24 GHz radar has a long range and ignores ambient weather like heavy rain and snow. However, its detection is limited to stronger radar targets. 122 GHz radar provides greatly increased accuracy and can see a much wider range of materials compared to 24 GHz. 60 GHz conveniently falls between 24 GHz and 122 GHz in terms of performance. It has remarkable resistance to ambient weather and can detect a similar range of materials to 122 GHz with a better accuracy than 24 GHz.

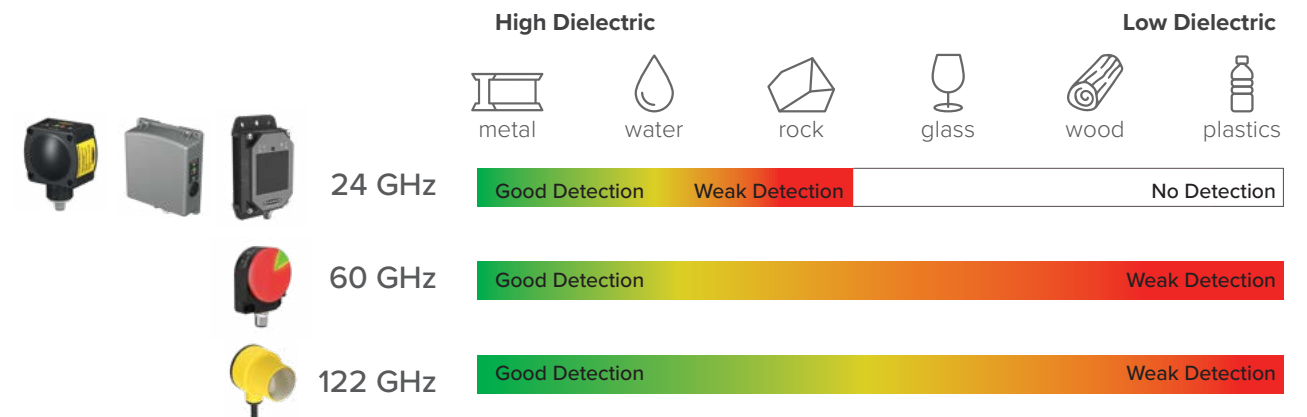

Metal, water, and other high-dielectric materials provide a stronger return signal than plastic, wood, or other organic materials.



## ZMX Series 3D Time of Flight Sensor

- Container fill monitoring made easy
- Detects peak height or volume over a large sensing area
- One unit offers more reliability than multiple single-point sensors
- Easy setup—simple integration, completely self-contained
- Requires no external lighting
- High ambient light immunity
- For model information see page 63

### Measure and Monitor the Contents of an Entire Container with One Sensor

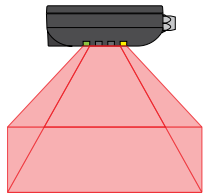

#### Large field of view

- Monitor a large 60° x 45° field of view
- View entire container, not just a single position

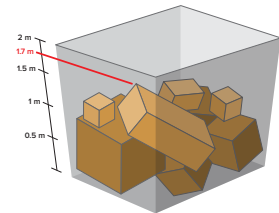

#### Peak height

- Continually monitor height
- Send an alarm when peak heights are reached
- 2.5 m range

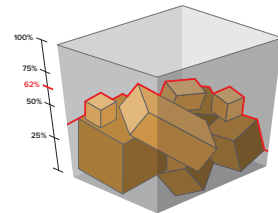

#### Percent fill

- Determine overflow of contents or packages
- Use the output to track the fill rate or container statistics

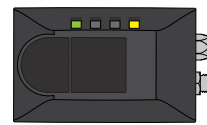

#### All-in-one design

- Logic is integrated into the sensor
- No PC or controller needed after initial setup
- No external lighting required

### Easy Setup and Integration

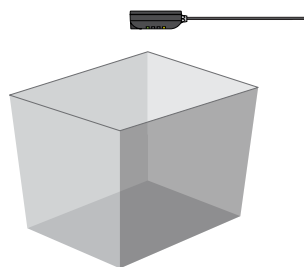

#### 1. Mount the sensor and connect

- Built-in mounting holes
- Variety of mounting brackets to choose from
- Connect to a PC to begin using Banner's 3D Time of Flight configuration software

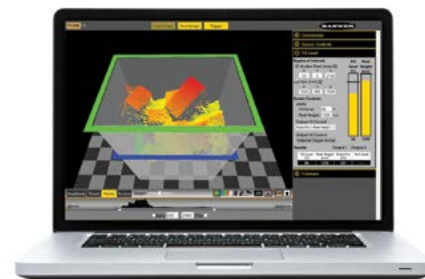

#### 2. Define sensing conditions

- Define the anchor point at the bottom of the container
- Define the size of the sensing region
- Choose the sensing criteria for the application: peak height or percent fill (shown above)

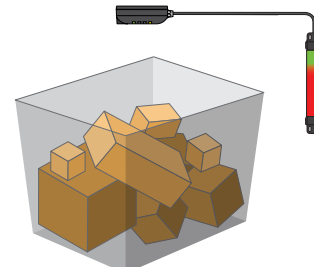

#### 3. Begin sensing

- Monitor within the entire 60° x 45° field of view
- Does not require any external controllers or PC



### Detecting When Carts Are Full

#### Challenge

When packages for shipment are collected into a cart from a conveyor or chute, a human operator or robot needs to be alerted when the cart is full and ready to be replaced with an empty one. Typically, photoelectric and ultrasonic sensors have been used for this detection task, but most have a small-diameter spot. This can provide inaccurate readings, because the packages will naturally fall into a pile of unpredictable shape—potentially with peaks and valleys, or with gaps between boxes—which a small sensor spot could easily misinterpret.

#### Solution

The ZMX 3D Sensor has been designed to monitor a wide area. Its three-dimensional field of view and 2.5-meter range ensures that it can accurately detect objects within the full space that the cart occupies. A single ZMX can observe the cart as it fills up with packages and send a notification signal when the cart contents reach a predefined height, regardless of object sizes, angles, or positions. This active monitoring prevents cart overflows.

### Ensuring Proper Stacking Heights for Palletized Items

#### Challenge

Warehouses, factories, and other operations that transport or store goods in bulk need to make sure that products are not stacked too high on pallets. Whether operators use forklifts or pallet jacks, excessive stacking heights can be unstable, risking damage, injury, and lost productivity in the event of tipping. A sensor is needed to monitor the full area of a pallet and alert workers if a specific stacking height is exceeded.

#### Solution

ZMX sensors use laser and digital imaging technology to detect objects in a wide, three-dimensional field of view. This provides better accuracy for monitoring pallet heights than can be achieved with fine-point photoelectric or ultrasonic sensors, because the full area of a pallet can be monitored. This not only prevents items from being stacked to unstable heights, but it also ensures that they do not extend beyond the reach of automated shrink-wrap machines.





## Machine Safety Products

Designed to be easy to use and implement, developed to protect personnel and equipment from accident and injury, and built to perform reliably in challenging environments, our comprehensive collection of machine safety products provide the highest levels of safety without compromising productivity.



### S4B Safety Light Curtains

S4B Heavy-Duty Type 4 Safety Light Curtains provide durable, dependable machine safeguarding.



### SI-RF Series RFID Safety Switches

SI-RF Series safety switches utilize RFID technology to monitor doors, gates, and other movable mechanical safeguards that separate personnel and equipment from a hazard.



### SI-GL42 Series Safety Locking Switches

Locking-style safety interlock switch for interlocking and position monitoring.



### ISD Connect

This compact T-connector brings a non-ISD enabled device into an ISD system.



### Illuminated E-Stops with ISD

Fully assembled illuminated E-stops with ISD enable easy installation and hookup with no assembly, individual wiring, or additional enclosure required.



### SC10 Series Compact Safety Controllers with ISD

Cost-effective, easy-to-use safety controller for smaller machines replaces the functionality of two or more safety relay modules and features an intuitive user interface and advanced diagnostic capabilities.



### XS26-ISDd Series Expandable Safety Controllers with ISD

The XS26-ISDd expandable safety controller has the capacity to adapt to a variety of machines, including large-scale machines with multiple processes.



# ISD Banner In-Series Diagnostics (ISD)

Easy-to-Implement Diagnostic Capabilities for Complex Safety Systems

In-Series Diagnostics allows connection of up to 32 devices with one in-series connection and communicate directly with the most commonly used PLCs.

When a safety event occurs the system receives an alert that includes information about which safety device tripped, making troubleshooting a breeze.

In-Series Diagnostics provides an array of additional data points for each in-series device used, including a unique tag value, internal temperature, voltage, and more, along with device-specific details such as the alignment and distance between a safety switch's sensor and actuator.

Additionally, the system sends warning alarms if devices are near to tripping, so issues can be addressed before your machine shuts down.

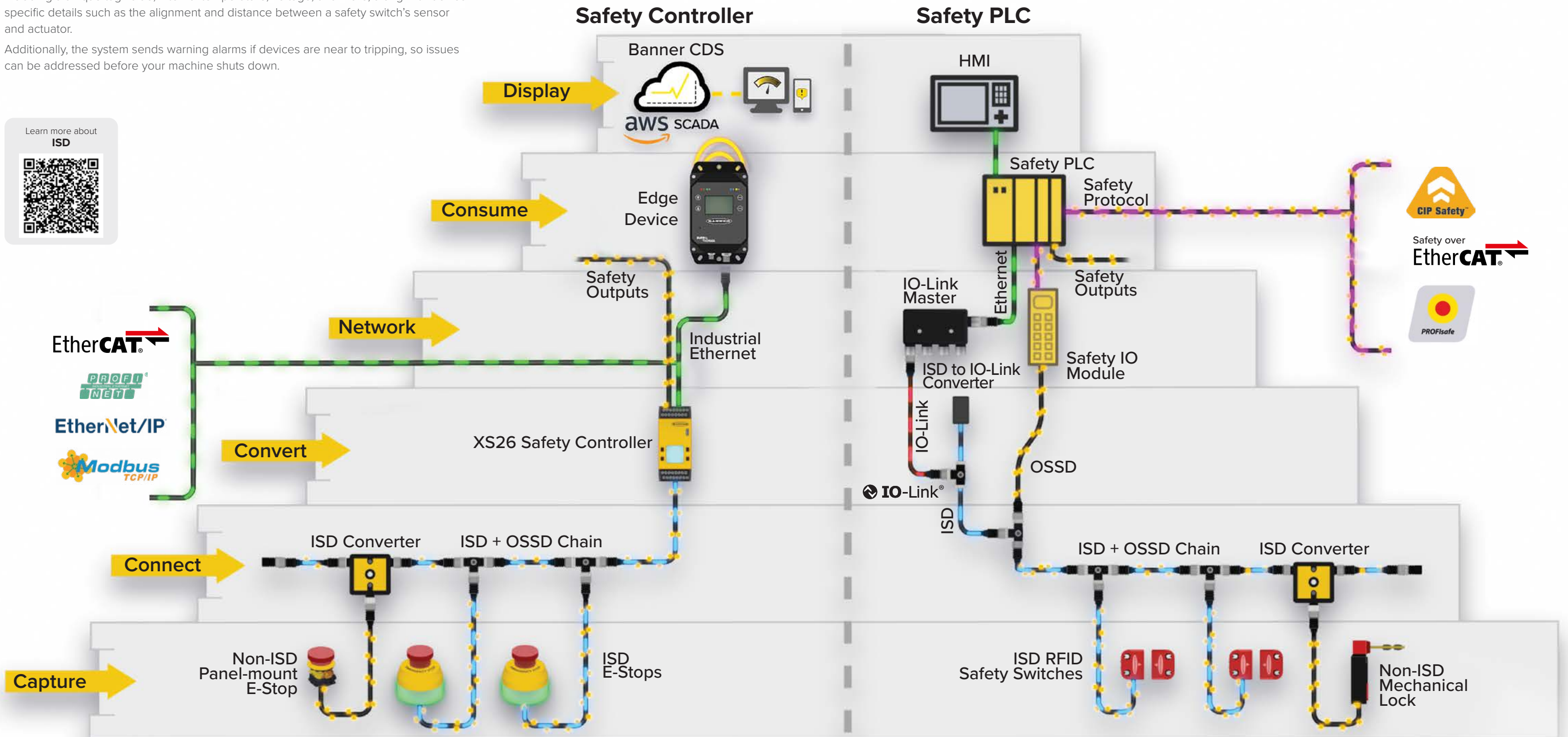

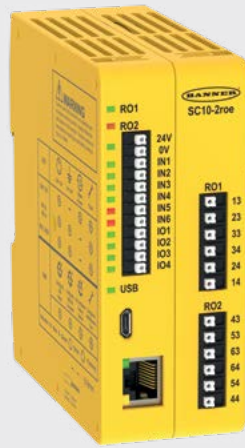

## SC10 Series Compact Safety Controllers with ISD

- PC configurable: flexible and easy to use
- Safety inputs: up to 70 with ISD
- Safety outputs: two independently controlled relay outputs 6A each
- EtherNet/IP, PROFINET, Modbus
- For model information see page 64



## XS26-ISDd Series Expandable Safety Controllers with ISD

- Safety controller plus ISD to PLC gateway
- Easy to configure with free PC software
- Connects up to 256 ISD devices
- Expandable up to 394 total safety devices and 68 safety outputs
- PROFINET, EtherNet/IP, Modbus TCP, EtherCat
- For model information see page 64

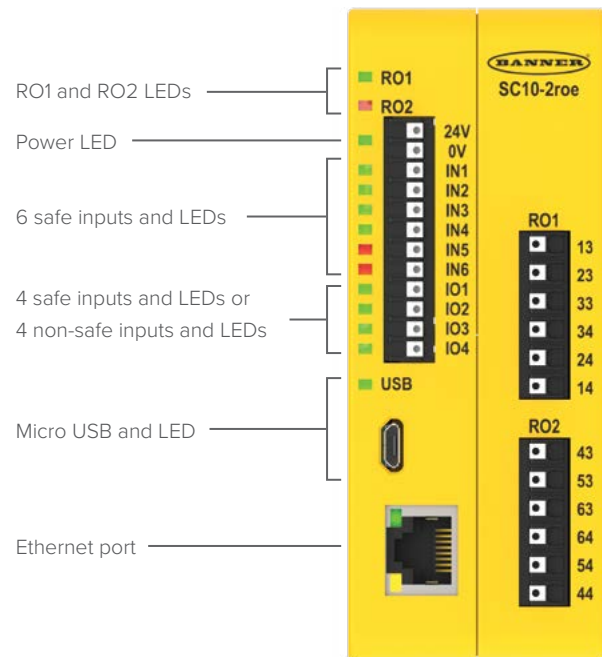

### SC-XM3—Fast Programming and Swapout

- Backup copy of configuration, password, and network settings
- Download configuration without a PC; save time during panel build
- Fast swapout to minimize downtime

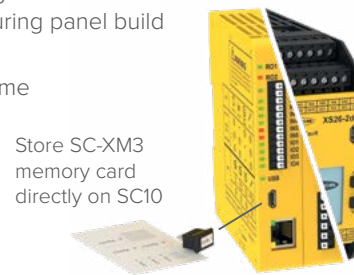

- 2 x 6A independently controlled relays (RO1 and RO2)
- 3 NO sets of contacts each

### Automatic Terminal Optimization (ATO)

Allows for an increase from ten to fourteen inputs

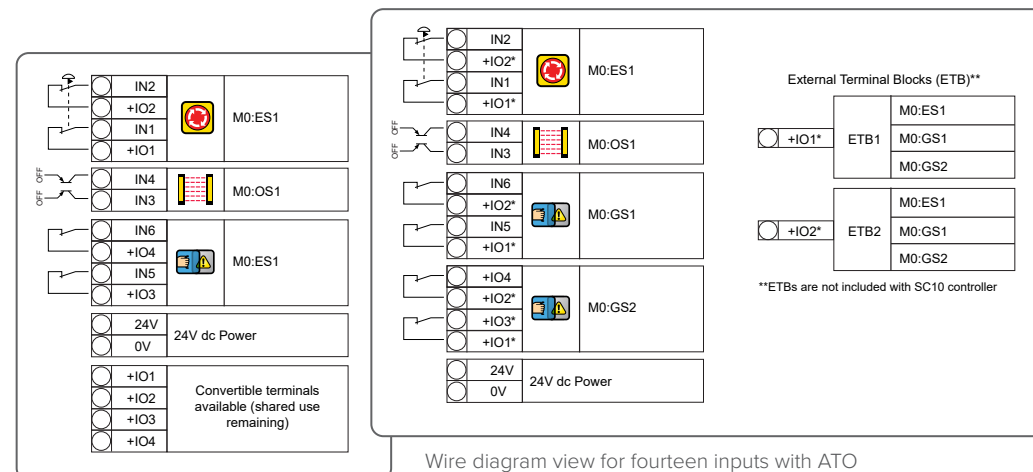

Wire diagram view for ten inputs without ATO



- Base Controller allows 8 of the 26 inputs to be configured as outputs for efficient terminal use
- Two independent pairs of safe outputs at 0.5A each
- In-Series Diagnostics (ISD) provides detailed status and performance data

- Optional display screen allows local diagnostics for efficient troubleshooting
- Up to eight expansion I/O modules can be added as automation requirements grow or change
- Choose from six expansion module models with a variety of safety inputs, solid-state safety outputs, and safety relay outputs
- Controller and input modules allow safety inputs to be converted to status outputs for efficient terminal use
- Fast programming and swapout using the SC-XM3 memory card



## SI-RF Series RFID Safety Switches with ISD

- Two-piece design in which the sensor and actuator do not contact
- High tolerance (10 mm) to misalignment enables reliable performance in challenging industrial environments
- IP69 solutions available
- Available with the highest level of tamper resistance
- For model information see page 64



## S4B Series Heavy-Duty Type 4 Safety Light Curtains

- Install quickly and easily with LED alignment indicators and brackets
- Prevent downtime using weak beam strength LED indication and output
- Helps eliminate costly repairs by incorporating 5-pin M12 removable connections
- For model information see page 64

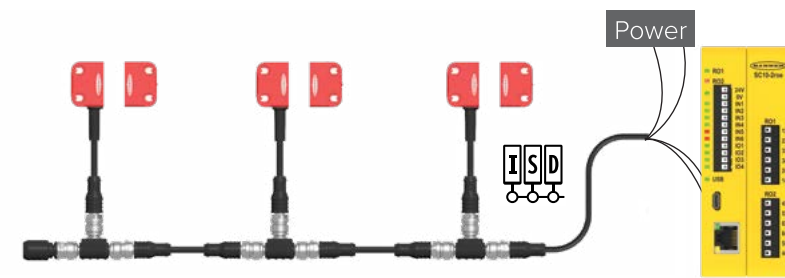

### RFID Cascade with In-Series Diagnostics

- Multiple-door RFID non-contact gate/door sensing solution
- 4-pin QD connections for cost-effective, simple, error-free installation
- Connect up to 32 sensors in series
- Door status and sensor health sent to PLC/HMI for simple troubleshooting

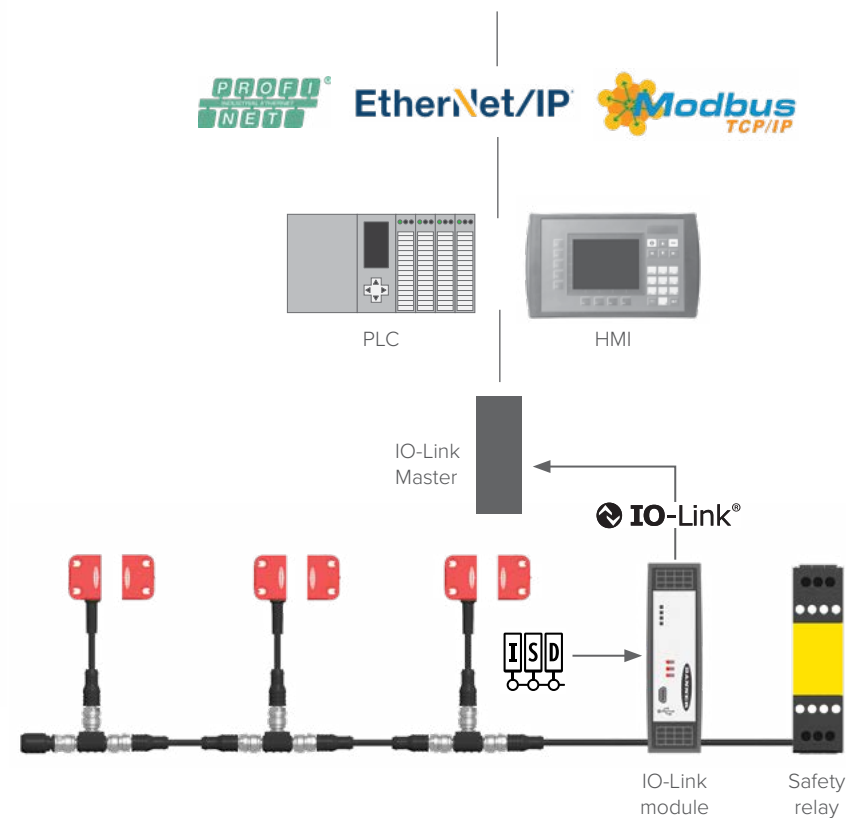

**Simple Installation**  
The S4B is designed and optimized for easy and intuitive installation, operation, and troubleshooting. Zone LEDs aid troubleshooting and help reduce downtime.

### Alignment Zone Indicators

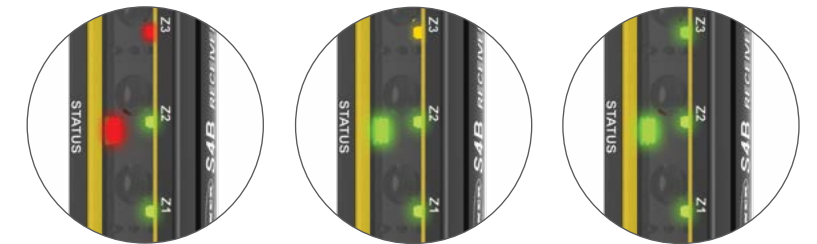

- Misaligned**  
Red indicates a loss of signal due to a blocked beam or significant misalignment
- Weak**  
Yellow indicates a weak signal due to a slight misalignment
- Aligned**  
Green indicates a strong signal, proper alignment, and a lack of obstruction

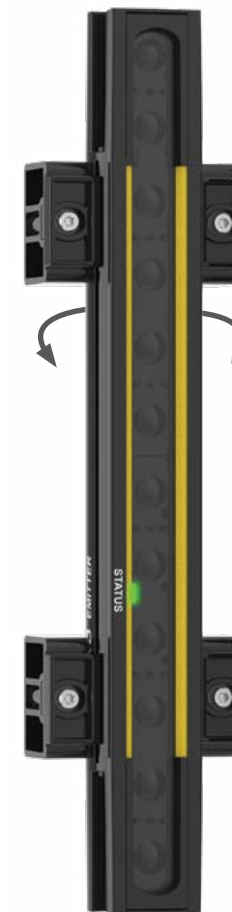

Rotating and locking brackets

**Intuitive Setup and Swapout**  
Select and save scan code setting without a PC for easy setup and swapout





## Illuminated E-Stops with ISD Resolve Issues and Prevent Downtime

- Available with In-Series Diagnostics (ISD), which provides detailed status and performance data from each connected button
- Patented E-stop base will flash red when actuated and indicate armed status with either green, yellow, or no illumination
- One-piece, fully enclosed button with M12 connection reduces time and labor of installation; button diameter options and button shrouds available
- Rugged design rated to IP65 for use in harsh environments; IP69 cover available
- Models available with local reset input
- For model information see page 65

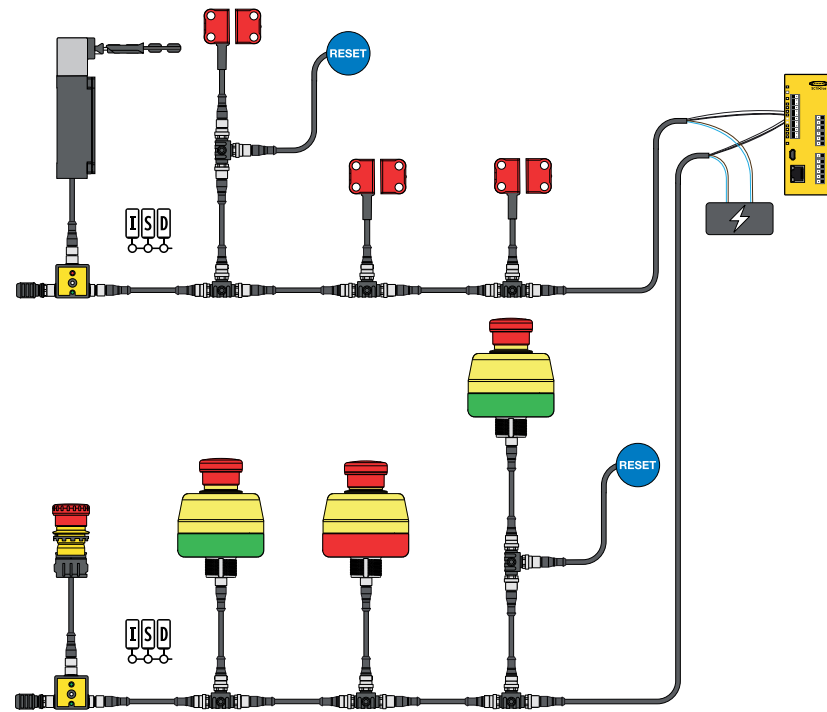

### Related Product



## ISD Connect T-Connector

- Connects a non-ISD-enabled safety device with 2 normally closed sets of contacts, such as a panel-mount E-stop or safety switch, to an ISD chain
- IP67-rated and installs easily, with no assembly or individual wiring required
- 5-pin M12 female port for connecting an input device
- Access diagnostic data, prevent system faults, and reduce equipment downtime of non-ISD devices
- Built-in indication for input device and ISD status
- Center mounting hole for simple and versatile installation
- For model information see page 65



## SI-GL42 Series Safety Locking Switches

- Lightweight, robust design with plastic body and metal for mechanically stressed components
- Actuator head rotatable in 90° increments, providing five positions, including vertical
- Choice of spring lock with energized solenoid release or energized solenoid lock with spring release
- Multiple actuator and monitoring contact configurations for any automation safety application
- Some models compatible with Banner's exclusive In-Series Diagnostics (ISD) system for data-driven insight
- Activated locks can be manually unlocked with a tool if machines need to be accessed for maintenance or repair
- For model information see page 64



### Actuators

#### SI-QM-SSA-2

- Straight rigid actuator for sliding or removable guards



#### SI-QM-SSA-2RA

- Flat rigid actuator for sliding or removable guards



#### SI-QM-SMFA-2

- Flexible actuator for small hinged guards 150 mm or larger



#### SI-QM-SMFA-3

- Flexible actuator for small hinged guards 400 mm or larger



Sliding door handle with mechanical latch simplifies installation and provides latch function to prevent switch and actuator damage and optimizes alignment.



## SX5 Series Safety Laser Scanners

- Master and remote functionality with simplified setup and wiring
- Protects personnel and equipment with three independent safety outputs
- Features 70 unique safety zone sets, encoder inputs, and advanced measurement data—ideal for complex applications
- Cost-effective, compact, one-piece design with 275° of monitoring
- Horizontal or vertical detection zones to reliably safeguard mobile vehicles, access points, work areas, and more
- For model information see page 65

### 275 Degrees of Coverage

275 degrees of coverage makes it easy to mount on a corner

Maximum range for safety zone: 5.5 m

Maximum range for warning zone: 40 m

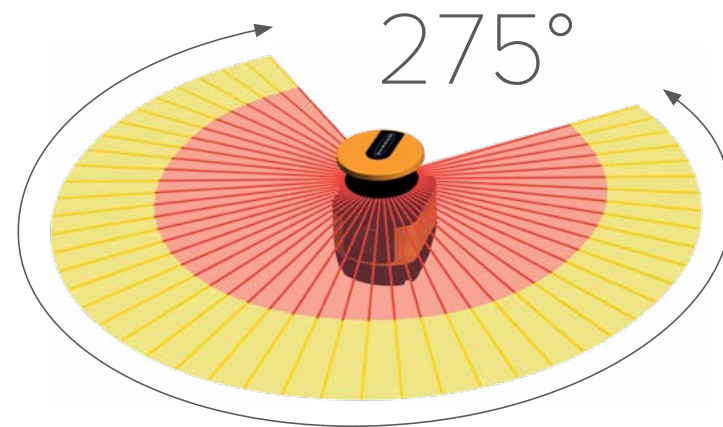

### Monitor up to three safety areas simultaneously

Three independent safety outputs allow you to monitor up to three distinct safety areas, simplifying wiring, setup, and installation. It's like having three scanners in one.

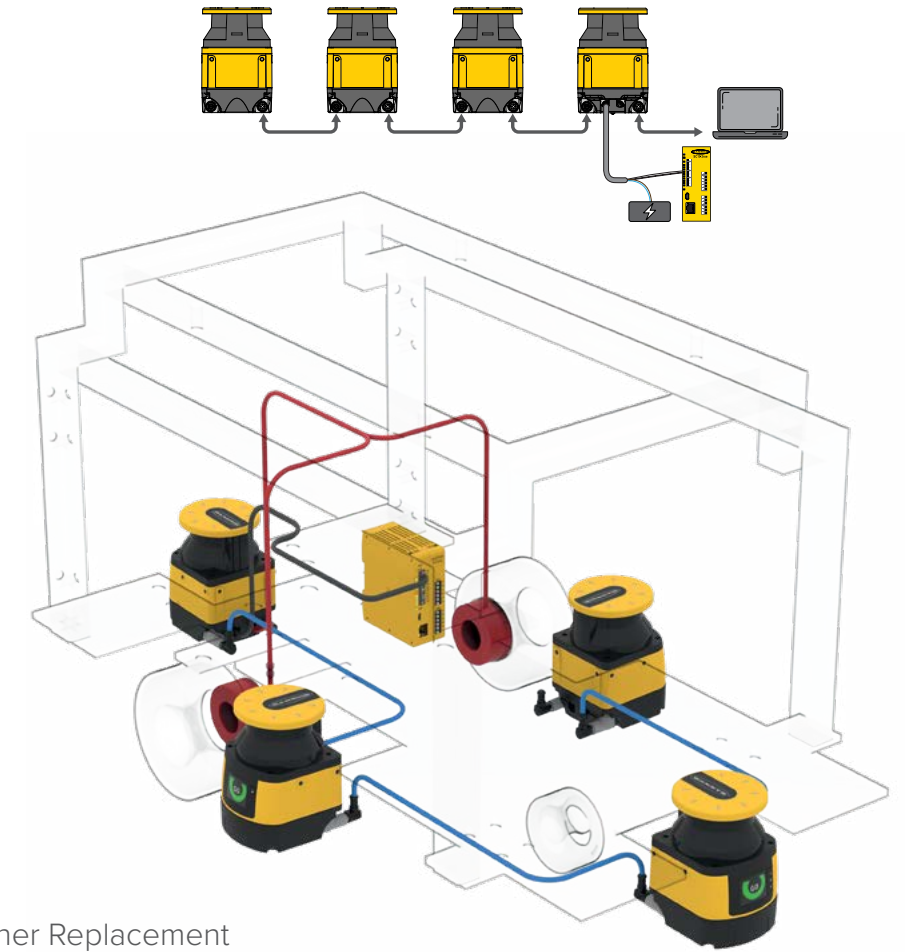

### Removable Memory for Fast Scanner Replacement

The system configuration is backed up in a removable memory unit. Install your replacement scanner quickly and easily, without needing to reconfigure your system.

### Simple Setup for Rapid Deployment

The SX5 can be set up in just a few simple steps using Banner's free configuration software. This robust software features menu-driven tools that guide users through setup and make it easy to design custom safety and warning zones to accommodate existing infrastructure and meet the specific needs of any application.

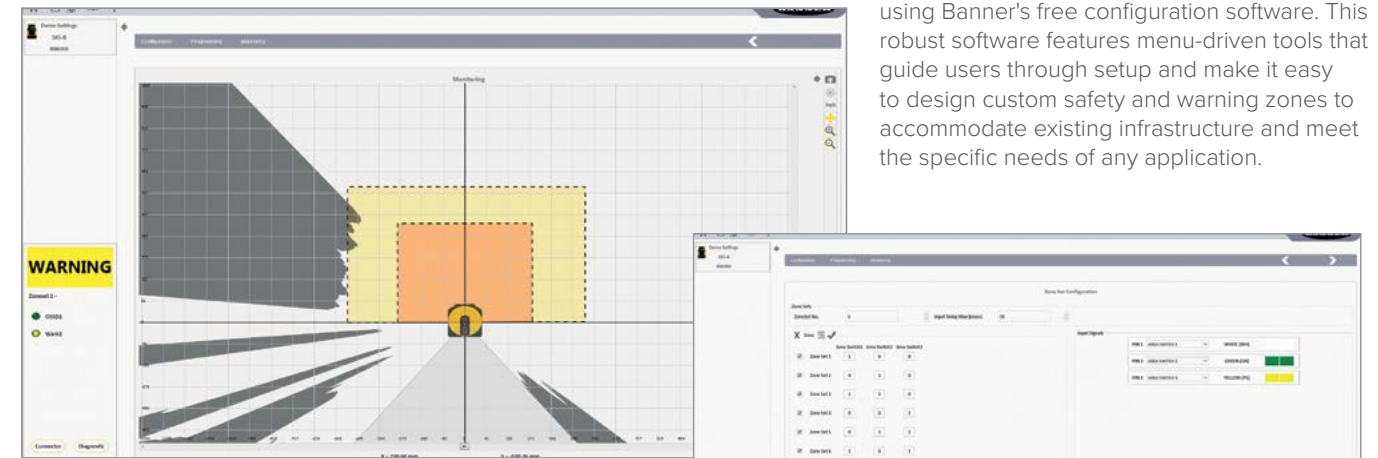

The software displays a graphic rendering of the monitored area and provides configuration and management tools, such as drop-down menus, function-specific worksheets and more.



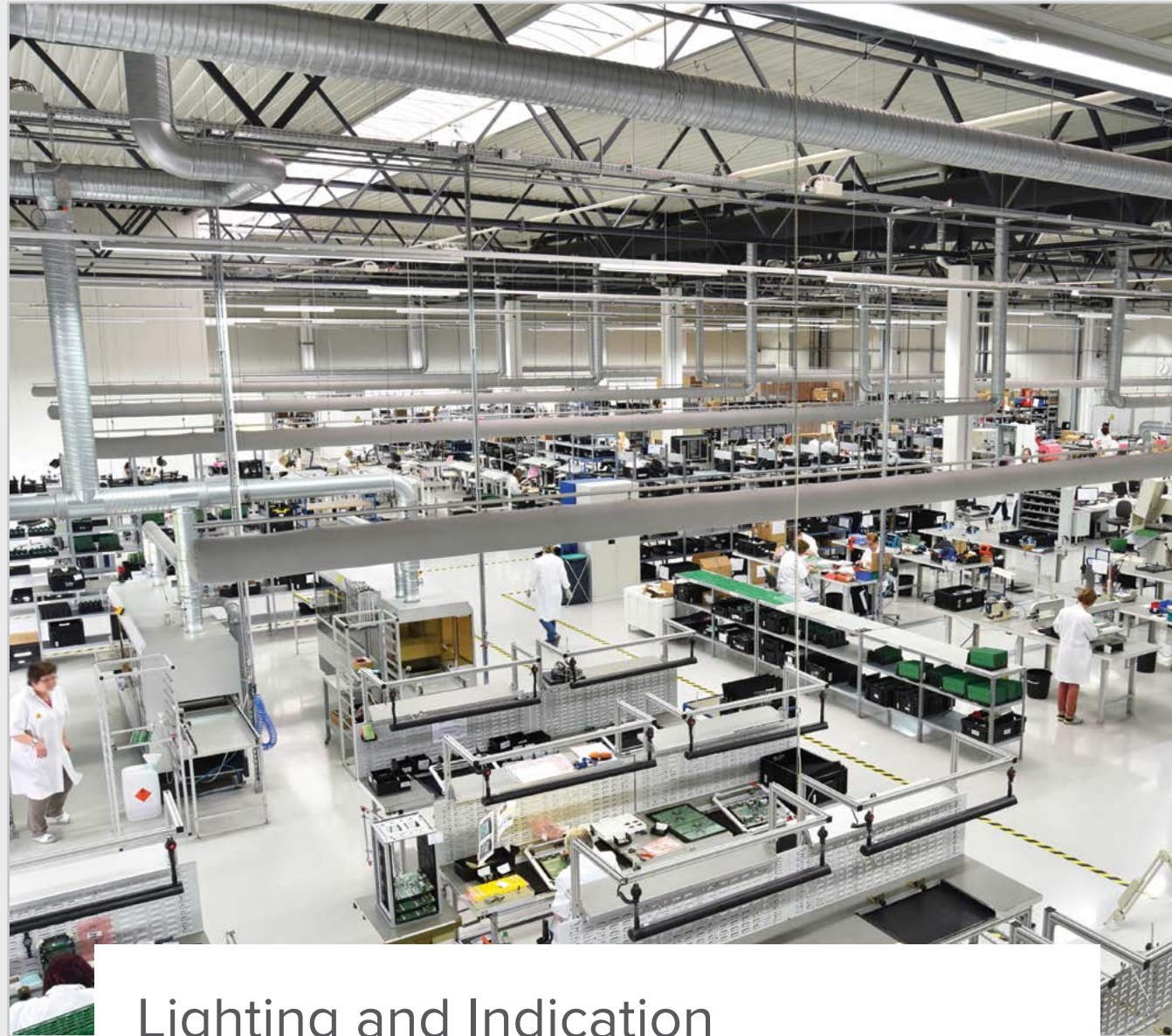

## Lighting and Indication

Banner's expanding selection of lighting, tower lights, indicators, audible alarms, and actuators provide superior-quality illumination, clear status indication, and unmistakable operator guidance. Banner offers the low-power, maintenance-free advantages of LED technology as well as programmable LED devices, which provide users the ability to configure color, flashing, dimming, and advanced animations.

### Communicate Status

- Empower operators
- Alert supervisors
- Accelerate resolution
- Plant-wide

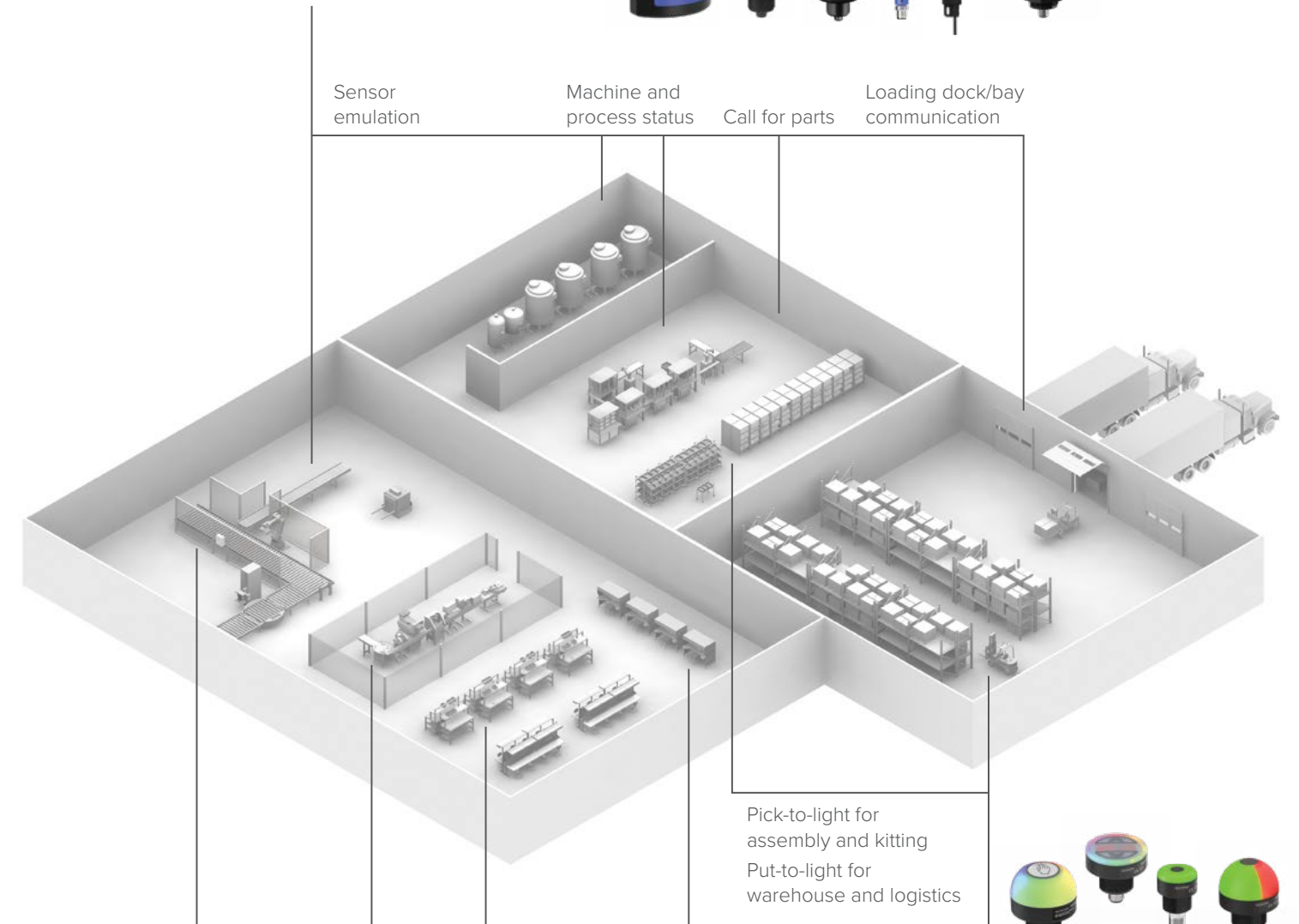

Electrical panel lighting      Machine lighting      Workstation lighting      Visual inspection station



### Illuminate the Work Area with LED Lighting

- Boost worker productivity
- Improve product quality
- Reduce energy costs



### Increase Efficiency with Light-Guided Part Picking

- Reduce cycle time
- Error-proof assembly
- Streamline training



# What is Pro?

The Pro Series of programmable multicolor LED devices from Banner Engineering offer limitless possibilities for advanced indication of dynamic machine states, operator interaction, and process statuses. The Pro Series is ideal for users who are looking for greater flexibility or more advanced capabilities than a traditional device provides. Discrete devices are programmed with Banner's Pro Editor software and controlled with traditional I/O. IO-Link and serial PICK-IQ devices are network controlled to customize visual communication across a factory.

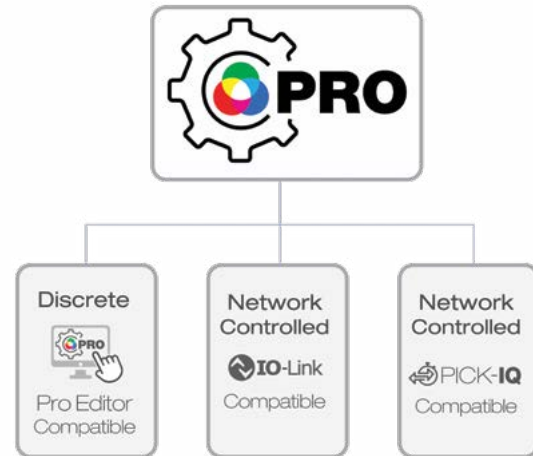

## IO-Link for Dynamic Control

### Reduced Costs and Increased Efficiency

IO-Link models allow for dynamic control—reacting to inputs from other devices—and have additional modes that discrete devices do not. IO-Link enables users to change device parameters from the control system as needed, such as during product changeover, which reduces downtime and allows machines to accommodate greater product diversity. These models also offer unique LED color management to provide advanced users with total control.

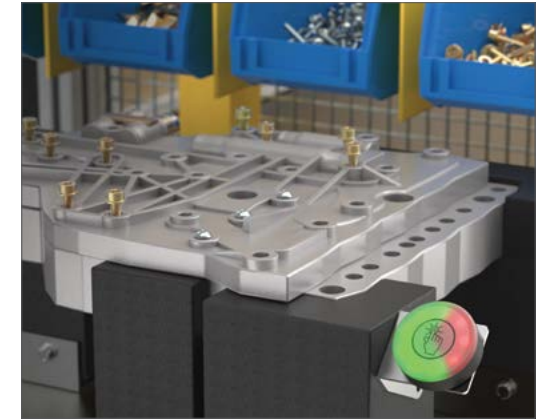
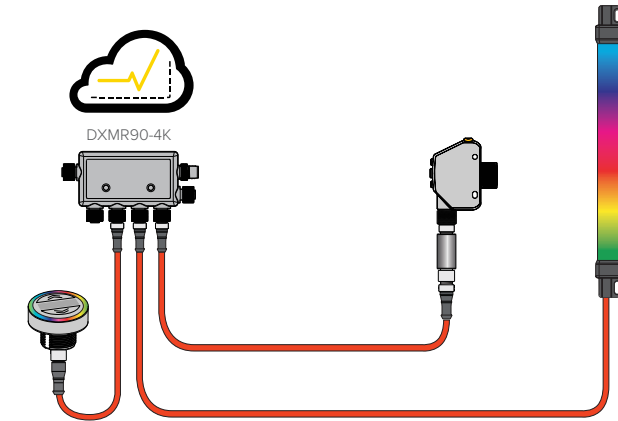

## Pro Editor Software for Intuitive Indication and Interaction

### Software for Programmable Discrete-Controlled Devices

Banner's Pro Editor software allows users to program device status, colors, animations, and much more for control via discrete inputs. The application-based interface makes it easy to configure a device for a wide range of applications, such as displaying machine warm-up time, indicating unique steps in an assembly process, showing distance and position information, and communicating multiple machine states.

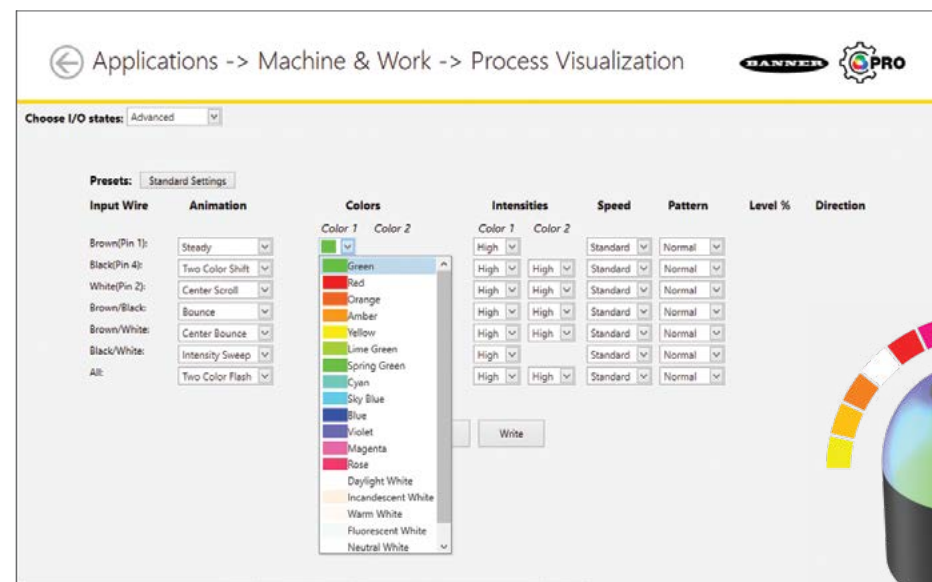

## PICK-IQ® for High Device Density

### Faster Response Speed and Simplified Programming

PICK-IQ® is a purpose-built serial protocol that maintains high speeds even in networks with a high device count. Devices with PICK-IQ® allow full access to color, flashing, rotating, and dimming settings as well as advanced animations such as process statuses and LED control. Devices with PICK-IQ® are typically used in pick-and-put walls, light-guided assembly, and other high-density installations with close device proximity.

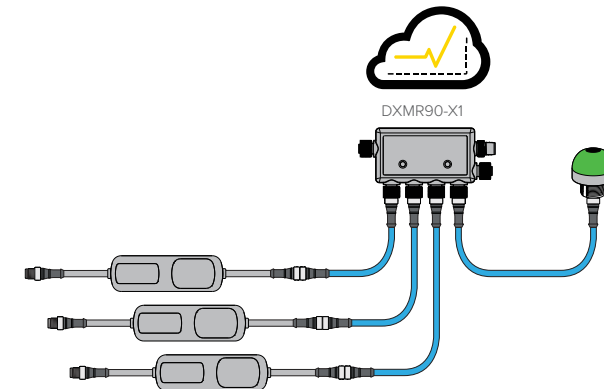



## Pro Products Give Your Light Full Control

For illumination, indication, or interaction, the family of Pro products from Banner enable advanced capabilities and control throughout a visual environment.



### LED Indicators

- Configure color, flashing, intensity, rotation, and sound
- Up to fourteen colors, five different sizes for machine or panel mount
- Pro Editor models offer simple wiring, enabling easy setup and reduced installation time
- PICK-IQ® devices provide the ideal solution for production lines and fulfillment stations that require dynamic indication
- Models with IO-Link communication enable almost limitless capacity for custom indication
- Simplify purchasing with fewer models that can be customized in-field, saving costs and inventory requirements

### Touch Buttons

- Pro actuators offer advanced animation customization and faster response speed
- Configure color, animation, intensity, and activation logic
- Touch buttons offer excellent immunity to false triggering by water spray, oils, and other foreign materials
- Optical sensor models are immune to ambient light, electromagnetic interference, and radio frequency interference
- Can be actuated with bare hands or gloves and have the added feature of adjustable sensitivity
- Compatible models are programmable using Banner's IO-Link system for customization of colors and animation
- Models with PICK-IQ® feature faster response speeds over a serial network



### LED Strip Lights

- RGBW LEDs for illumination and indication plus timer, counter, distance, and gauge modes
- Six white color temperatures for comfort and compatibility
- Provide high visibility status indication
- Versions available for Pro Editor, IO-Link, and PICK-IQ® to suit all your needs or integrate with other Pro products
- IO-Link helps reduce costs, increase process efficiency, and improve machine availability
- Available in multiple lengths from 150 to 1200 mm
- Visually communicate distance and other sensor measurements with Pulse Pro I/O™



### Tower Lights

- Fourteen colors, three segment types, and two housing colors
- Classic segment control plus action, timer, counter, and level modes
- Pre-assembled and preconfigured multi-segment LED tower light indicators replace conventional stack lights, which often require time-consuming assembly and complex wiring
- Self-contained tower lights provide users with custom indication by combining the vast color options provided by RGB LEDs with the versatile control capabilities offered by either Pro Editor software or IO-Link communication



# Hazardous Location Lighting

Hazardous LED lights from Banner Engineering can withstand harsh environments, exposure to inclement weather, and perform in rugged conditions. Ideal for challenging indoor and outdoor applications, these lights often come in durable, fully-sealed housing; are certified for use in potentially unsafe environments; and provide bright illumination for operator guidance. Products carry certifications from cULus, CSA c/us, ATEX, IECEx, or several for universal use around the globe.



## WLA-2 Series Industrial LED Area Lights

- Designed for illuminating industrial work cells and machines, for inspection and machine vision applications, and in areas with exposure to liquid, such as food, beverage, and packaging
- Illuminates a large area with an even pattern of light and no shadows
- Rugged, thermoplastic housing rated to IP69K for heavy duty washdown
- Encapsulated housing option rated IP68 for prolonged exposure to water and submersion
- Lensed models available for intense, close-range inspection or long-range projection
- For model information see page 66



### HLS27 Bright LED Strip Lights

HLS27 LED Strip Lights for hazardous locations have a sturdy aluminum housing and are encased in a shatterproof, UV-stabilized polycarbonate shell, making them ideal for harsh indoor and outdoor applications. The option of having multiple colors in one device makes this ideal for mobile vehicle, machine status, and vision lighting applications. It has certifications for cULus and ATEX/UKCA/IECEx.



### K50 50 mm Multicolor Indicators

K50L indicators feature an illuminated dome for easy-to-see operator guidance and indication of equipment status. Ideal for use in hazardous areas, it is rated IP67/IP69K for washdown and has certifications in ATEX, CSA c/us, and IECEx.



### HLS28 LED Strip Lights for Enclosures

HLS28 Hazardous Location LED Strip Lights have a sturdy aluminum housing, shatterproof windows, and a low-profile, space-saving design for use in certified enclosures in hazardous locations. The light is available with an integrated motion sensor for auto-on when the enclosure door is opened, or anytime motion is detected. It has certifications for cULus and ATEX/UKCA/IECEx.



### K100 Pro Hazardous Beacons

K100 Pro Hazardous Beacons are designed for use in oil, gas, and other hazardous locations. With an environmental rating of IP66 and IP69K, these durable hazardous models can withstand high temperatures, protect against vibration, and are dustproof. They are rated cULus, CID2, CIID2, CIID1, and CIID2 for use in settings in which flammable gases, vapors, mists, or dusts are present.



### K30 30 mm Multicolor Indicators

Rugged, cost-effective multicolor indicator light made for use in hazardous areas. It is ATEX, CSA c/us, and IECEx certified; fully sealed; and rated to IP67/IP69K for harsh environments.



### Waterproof for Any Application

- Sealed and rated IP69K for high-temperature and high-pressure washdown
- Ideal for food and beverage applications or on CNC machines

### Optimal Flexibility

- Available in four sizes and three window types



### More Illumination

- Twice the light output as its predecessor
- Tested solution for area lighting, machine lighting, and machine vision
- Illuminates larger areas than strip lights



## TL15 In-Line Tower Light Indicators

The TL15 In-Line Tower Light is an ultra-small, modular indicator that can be used standalone, or connected in-line with a tower light, sensor, touch button or other device to display signal status. Its in-line connection and distinct indication give users a simple way to add status information where needed, improving issue response time and increasing throughput.

- Over-molded IP66, IP67, and IP68 design for use in harsh environments
- Green, yellow, red, and blue models, each with a specific activation pin
- All signals pass through an M12 in-line connection, simplifying installation without disruption to I/O
- Small, modular design allows for installation flexibility into tighter areas
- For model information see page 67



## K30 Pro Optical Multicolor Indicator with Optical Sensor

- Sensing and indication in one device
- Pro Editor Software gives users the flexibility to define indication colors, range, and logic
- Remote input enables range definition without a controller for fast, simple setup
- Touchless activation eliminates the possibility of contamination and the need for physical force to operate
- Adjustable range from 20 to 1000 mm for detection where needed, and ignores objects in the background
- Use configurable indication states to show target position/distance
- For model information see page 67



### Low-Profile, Over-Molded Design

- Highly visible body
- Over-molded IP66/67/68 design is reliable and rugged to withstand harsh industrial environments
- Low-profile design makes it ideal for bright indication in tight spaces

### Highly Visible Indication

- Provides easy-to-see status indication
- LED lighting technology saves energy and minimizes replacement costs
- Four colors: blue, green, yellow, and red
- Visible statuses can be used to guide operators or communicate upcoming machine movements

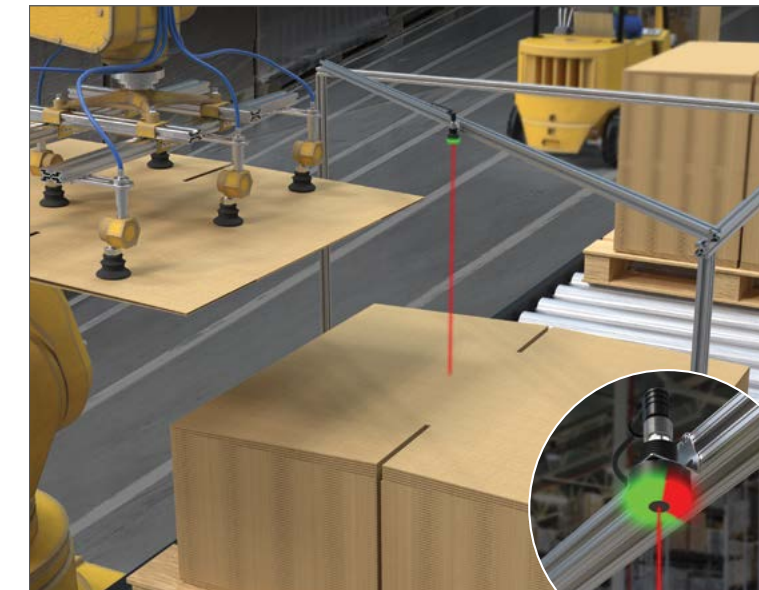

### Indicating Stack Level on a Robotic Case Erector

- By using the K30's distance mode, operators who were tending multiple stations could quickly verify the stack level of boxes
- This allowed them to prioritize refill activity to prevent material shortages and eliminate downtime
- With this intuitive and highly visible transition from green to red, a single operator could easily identify when boxes needed to be refilled at multiple workstations
- A discrete output from the K30 can send a signal back to the control system to alert the supervisor

### Related Product



## TL15A In-Line Audible Indicator

- The TL15 Series has expanded to include an audible model for audible status indication
- Can be used in-line with TL15 tower lights or as a standalone device alongside other lights or sensors for additional audible indication
- For model information see page 67



## K50 Pro Touch with Display Programmable Compact Indicators

An ideal interface device for pick-to-light, condition monitoring, and general operator interaction in industrial environments. It enables users to clearly communicate status and receive feedback, improving throughput and productivity.

- Four-digit, seven-segment LED display
- Two independent touch areas
- Excellent immunity to false triggering by water spray, oils, and other foreign materials
- Can be actuated with bare hands or gloves
- For model information see page 67



## K50 and K70 Pro Touch with Audible Programmable Multicolor Touch Buttons

Pro multicolor touch buttons combine proven touch technology and ruggedness with the added versatility of RGB LEDs.

- Bright LED indicators combined with touch-activated switching capabilities
- Advanced touch technology allows for high immunity to water while still working with gloves
- An integrated audible alarm expands product functionality to provide additional indication and feedback
- Models made with FDA-approved materials are available for use in the food and beverage industries
- For model information see page 68



### Four-digit, Seven-segment Display with Two Touch Sensors

- Dual-touch surfaces enable increment/decrement and choose/select functionality that is difficult with standard, single-touch buttons
- Four-digit alphanumeric display enables users to communicate more information, can be inverted, and can scroll longer messages
- IP67 and IP69-rated, allowing users to install it without any additional enclosure

### Programmable RGB Configurability

- Combine proven technology and ruggedness with the added versatility of RGB LEDs
- Fourteen colors to choose from, including red, green, blue, yellow, orange, white, and amber
- Customize color, animation, intensity, and activation logic
- Limitless possibilities for advanced indication of dynamic machine states, operator interaction, and process statuses



### Bolder Indication for Everyone, Anywhere

- Get seven colors via only three inputs
- Save controller outputs and wiring
- Improve production efficiency through enhanced visual management
- Install wherever you need indication to improve communication and productivity
- Standardize to simplify ordering and spare parts
- Collaborate with Banner on custom models
- Enhance troubleshooting and branding with colors dynamically using IO-Link models
- Create your own custom units with Pro Editor software or IO-Link
- K50 compact models are available for low profile applications
- Audible models are available with fourteen different tones with customizable intensity



Avoid nuisance maintenance and replacement expense

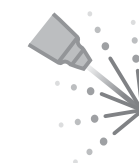

Rely on performance in washdown and humid environments



Select compliant models for use in food and beverage processing



Hear status information directly



Customize device configuration with advanced color and animation options



Simplify ordering, stock and spare parts with flexible, customizable units



## K50 Pro Audible Programmable Audible Indicator

Programmable audible indicator provides distinct status indication and is available with Pro Editor software or IO-Link communication for additional versatility and customization.

- Pro audible models are designed with integrated audible alarm to provide a distinct, loud notification of status
- Twelve different tones available including intensity, customization, and input control
- 97 dB maximum sound intensity status indication that adds nuance to the visual factory
- For model information see page 67



## CL50 Pro Programmable RGB Column Lights

- Rugged, versatile, and easy-to-install multicolor indicators
- Bright, easy-to-see operator guidance and indication of equipment status
- Programmable using Pro Editor software or dynamically controlled with IO-Link
- Customized indication possibilities, including color, flash patterns, and light intensity control
- Audible models available with sealed, omni-directional audible element
- For model information see page 68

### Audible Tones

Continuous	Pulse	Wobble	Staccato	Strobe
Whoop	Jingle	Melody 1	Melody 2	Melody 3
Siren	Custom Tones	Low Intensity	Medium Intensity	High Intensity



### Intuitive Software with Advanced Capabilities

- CL50 Pro Column Lights utilize bright, multicolor RGB LEDs that enable customized indication possibilities, including color, flash patterns, and light intensity control
- Pro Editor compatible models utilize an intuitive software interface to enable fully customizable color and wiring combinations via discrete inputs
- Pro Editor software users can access up to fourteen different colors and unique animations that attract attention and effectively communicate status



### Dynamic Communication for Seamless Control

- IO-Link models allow for dynamic control—reacting to commands from an IO-Link Master—and have additional capabilities that discrete units do not
- Offers the ability to change device parameters from the control system as needed, such as during product changeover, which reduces downtime and allows machines to accommodate greater product diversity
- Features unique LED color control



## TLF100 Pro Flush Mount Tower Lights

The TLF100 Pro Flush Mount Tower Light offers superior indication, advanced animations, an audible option, and a sealed, IP65 and IP69K-rated housing for indoor and outdoor environments.

- Rugged, versatile, and easy-to-install flush mount three- and four-segment tower lights
- IO-Link gives full access to color, flashing, and dimming settings, as well as advanced animations like run and level modes, which provide dynamic response to changing machine conditions
- Programmable using Banner's Pro Editor software and Pro Converter Cable
- Twelve selectable audible tones and audible intensity control
- Bright, single-color LEDs provide highly visible indication for indoor or outdoor applications
- For model information see page 69



## K100 Pro Programmable Multicolor Beacons

- Industrial beacon delivers bright, configurable indication for OEMs and users who need visible status information
- Daylight Visible models provide bright light, even in direct sunlight
- Rugged construction provides years of uninterrupted operation
- Multiple colors in one device
- Programmable using Banner's Pro Editor software and Pro Converter Cable (DC models)
- Rugged UV-stabilized polycarbonate base and window
- Pro Hazardous models available with and without audible
- HazLoc certifications for added protection in demanding environments
- For model information see page 69



Standard models for traditional applications (available in black and cool gray)

Threaded inserts for mounting



Daylight visible models for use in high ambient light environments

Sealed audible alarm with volume from 84–94 dB at 1 m

IP65 and IP69K-rated

Three or four segments

### Daylight Visible Beacon for indoor or outdoor applications

Unique water-shed beacon design helps protect the indicator

Three colors per device



Clear when off to avoid false indication



### Programmable Indicator Beacon for traditional applications

Rugged UV-stabilized polycarbonate base and window

IP66 and IP69-rated

Audible models available with volume from 93–101 dB at 1 m



Fourteen colors per device

### Modes and Animations

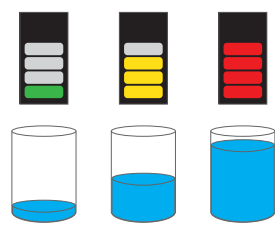

Level



Multicolor

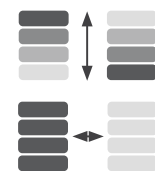

Intensity sweep



Audible



Timer



Scroll



Bounce



Flash



Counter

### Indication for Potentially Explosive Environments



### Indicating Operational Status of Boiler Room

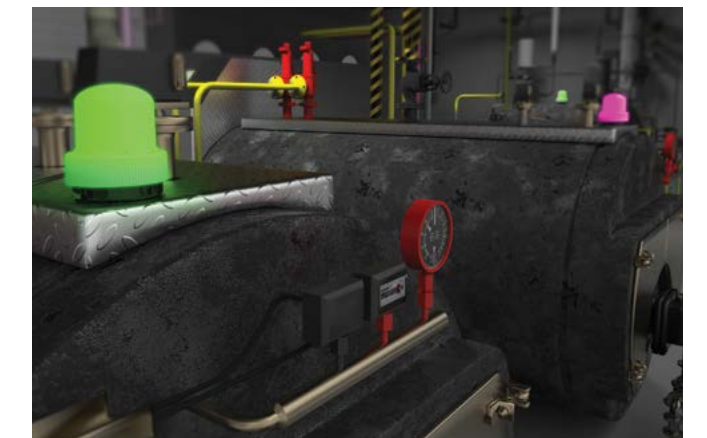



## Industrial Wireless

Industrial wireless products from Banner connect remote assets with the people who manage them, enabling real-time monitoring and management of equipment and conditions in difficult-to-access locations or where wired solutions are impractical, ineffective, or cost-prohibitive.

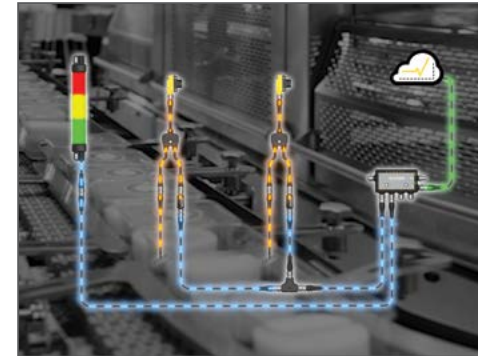

### Snap Signal® IIoT Hardware

Increase productivity and unlock your factory's true potential with Snap Signal: a hardware and software toolkit for your IIoT evolution.

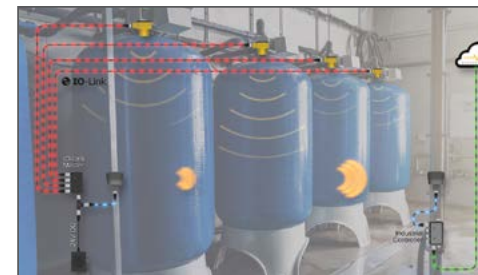

### IO-Link Hardware

IO-Link is an open standard serial communication protocol that allows for the bi-directional exchange of data from IO-Link-supported sensors that are also connected through a master. There are many advantages to using an IO-Link system, including standardized wiring, remote configuration, simple device replacement, advanced diagnostics, and increased data availability.



### R70 Data Radios

MultiHop Serial Data Radios are compact industrial, low-power wireless communication devices used to extend the range of serial communication networks.



### Banner Cloud ID Kits and Q45 Wireless Nodes

Get everything you need to capture critical data anywhere in production. Banner Cloud ID Kits and Q45 Wireless Nodes are easy-to-deploy, end-to-end solutions that handle operational challenges in real time — regardless of location. Kits let you track and analyze critical performance data over time to make better, more informed decisions.

## SNAP SIGNAL

Customers use Banner's Snap Signal hardware and software to instantly unlock valuable data from their equipment and increase productivity. This smart-factory portfolio forms an overlay network by capturing signals from existing and new devices, converting them to a unified protocol, and then distributing them to monitoring platforms, such as SCADA systems, the cloud, or a local PLC/HMI for consumption. The solution deploys easily by leveraging available information without disrupting your existing controls. This helps save you money, reduces downtime, and optimizes your operations.

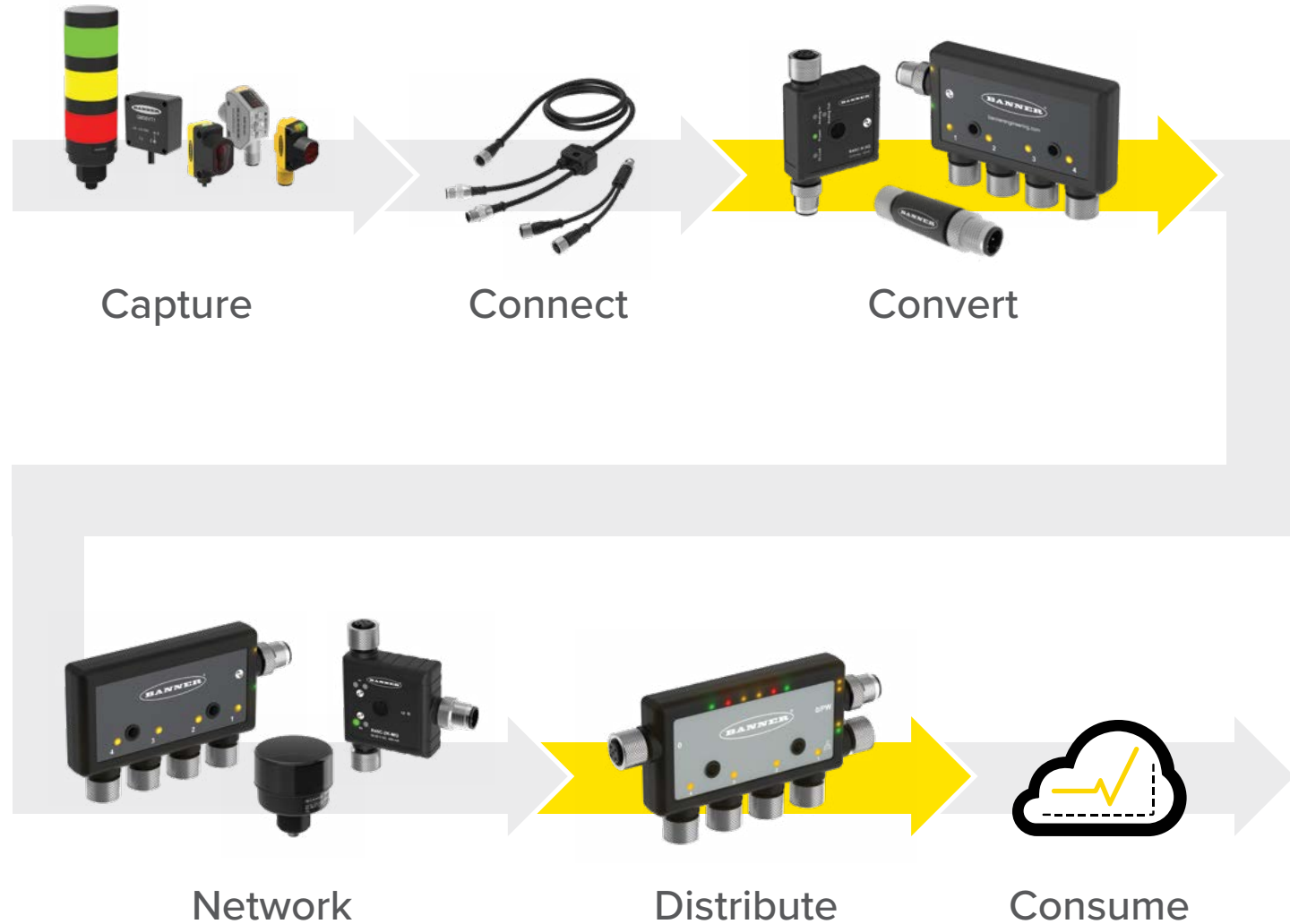

## Snap Signal Application Examples

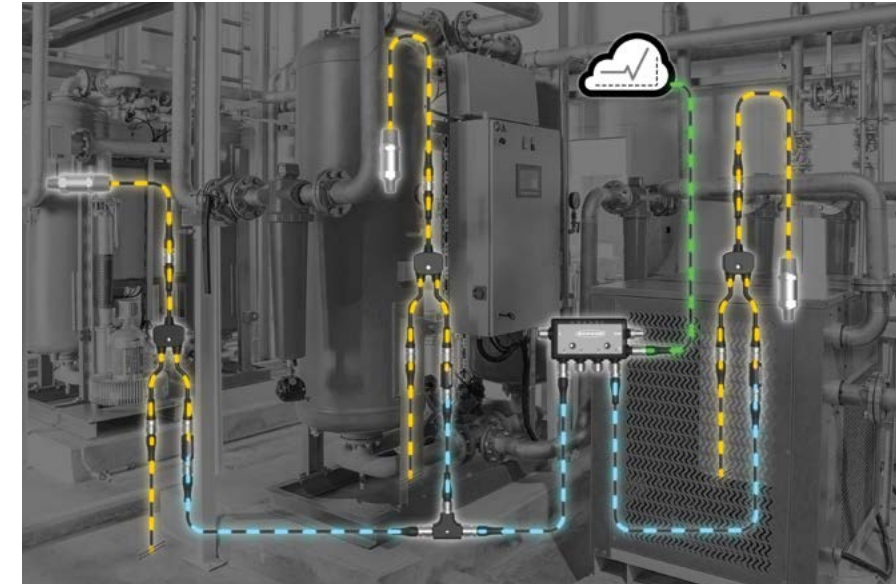

Tap into pressure sensor data for immediate insights

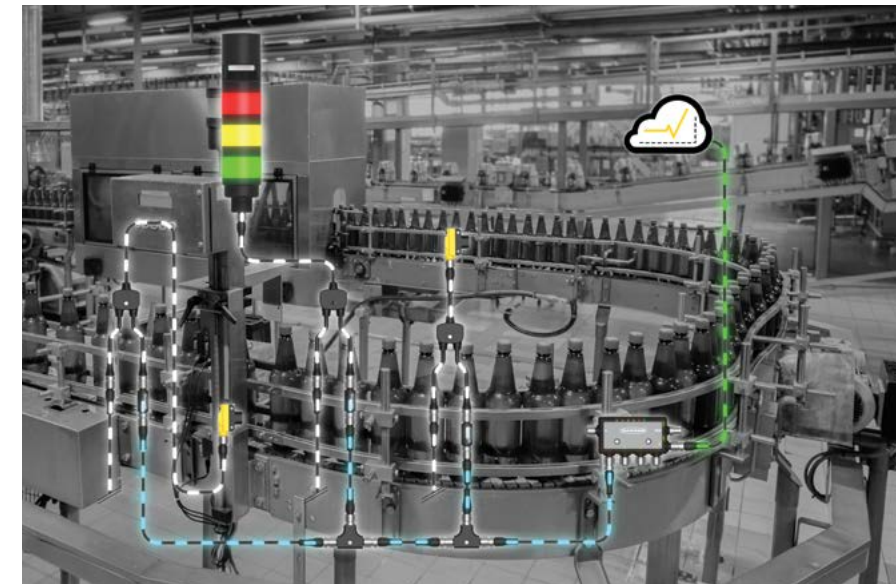

Maximize throughput and reduce downtime by harnessing sensor data from your equipment

Improve productivity, quality, and reliability with actionable data. Build smart machines and smarter factories with Snap Signal.

Snap Signal products are plug-and-play, helping customers gather information from their equipment and making it simple to view from anywhere. End users can use it as an overlay to harvest data from legacy equipment. They can simply tee into existing discrete sensors using a splitter to gather enriched machine-level data without disrupting the existing control systems. New sensors and devices can also be added to this overlay network. Machine builders and system integrators benefit from being able to add monitoring technology to equipment that can tie into any upstream system for data visualization.

# IloT Made Easy

Banner's Snap Signal family of plug-and-play products represents a new way to unlock your valuable machine data. Snap Signal offers you the flexibility to monitor key equipment within one area or monitor your whole facility. Whether you are retrofitting existing machines or building new infrastructure, designing and implementing with Snap Signal is easy and cost-effective.

The DXMR90 is an IloT-enabling industrial controller that transmits information from multiple sources simultaneously. It transmits data in a unified protocol for real-time analysis and consumption. Banner's S15C and R45C converters allow you to connect previously incompatible device types (including discrete, analog, and others), transform these signals to industrial protocols like IO-Link or Modbus, and seamlessly transmit data across multiple IloT ecosystems.



## DXMR90 IloT-Enabling Industrial Controllers

Banner's DXMR90 Series Controller consolidates data from multiple connections to provide local data processing as well as accessibility for host systems as a platform for the Industrial Internet of Things (IloT). The DXMR90 contains individual Modbus clients, allowing for concurrent communication to up to five independent serial networks. Data is collected into the controller to facilitate edge processing, convert protocols to industrial Ethernet, and send information where you need it.

- Converts Modbus RTU to Modbus TCP/IP, EtherNet/IP, or PROFINET
- Internal logic driven by action rules for easy programming, or MicroPython and ScriptBasic for developing more complex solutions
- Compact housing saves space and weight compared to traditional "block"-style form factors
- RS-485 and Ethernet communication ports
- User-programmable LEDs for local status indication
- Connects to databases (including Banner's Cloud Data Services) over Ethernet or through a cellular-enabled DXM controller
- Email alerts for critical assets can be set up in the cloud
- Ideal for IloT data analytics, condition monitoring, predictive maintenance, OEE analysis, diagnostics, and troubleshooting
- Available with IP65, IP67, and IP68-rated housings for use in challenging environments
- For model information see page 72



## R45C and R90C IO-Link Masters with Modbus RTU Interface

The R45C and R90C IO-Link Masters connect two or four IO-Link devices (model dependent) and provides access via Modbus RTU interface.

- Easy installation with no assembly or individual wiring required
- 5-pin M12 male quick-disconnect connector
- 4-pin M12 female quick-disconnect connectors
- Built-in indication for IO-Link Master ports and Modbus RTU connection status
- Rugged overmolded design meets IP65, IP67, and IP68 standards
- For model information see page 72



## S15S Temperature and Humidity Sensors

- Designed to work as a Modbus server device via RS-485
- Ships with aluminum grill filter cap; optional stainless steel 10-micrometer sintered filter available separately
- Achieves humidity accuracy of  $\pm 2\%$  relative humidity and temperature accuracy of  $\pm 0.3\text{ }^{\circ}\text{C}$
- Manufactured with a robust housing
- For model information see page 73

## S15S Infrared Non-Contact Temperature Sensor

- Non-contact infrared temperature sensor outputs temperature to Modbus registers
- By detecting emitted infrared energy, the S15S Non-Contact Infrared Temperature Sensor quickly and reliably checks temperatures touching the target
- Rugged overmolded design
- For model information see page 72







## R95C Discrete Bimodal to Modbus Hub

The R95C discrete bimodal to Modbus Hub connects two discrete channels to each of the eight unique ports, providing access to monitoring and configuring those ports via Modbus registers. Host mirroring is available where a selected port input/output discrete signal can be routed to Pin 5 (male) on the PLC/Host connection. For model information see page 73.

## R90C Modbus to Analog Hub

The R90C 4-Port Modbus to Analog Hub can output either 0 to 10 V, or 4 to 20mA, to each of the four unique ports. Writing to the appropriate Modbus RTU register allows the user to select the type of output—voltage or current—for each port.

- Connects directly to a sensor or anywhere in-line for ease of use
- Quick, easy, and economical way to integrate analog outputs into a Modbus system
- Rugged overmolded design meets IP65, IP67, and IP68 standards
- For model information see page 73



## S15C Converters

Break free from protocol limitations with S15C in-line converters. S15C converters take various types of signals such as discrete, analog, and others and convert these signals to smart protocols like IO-Link or Modbus. This makes it easy to incorporate existing legacy sensors into standard protocols to enable process monitoring. The converters are designed to connect directly to a sensor, indicator, or other device and begin operating immediately, fitting seamlessly into factory applications.

- Allows previously incompatible devices to be connected to a smart system
- Compact form factor
- Simple M12 connection for easy installation wherever needed in the circuit
- Rugged overmolded design meets IP65, IP67, and IP68 standards
- For model information see page 72



## IO-Link Hardware

In recent years, IO-Link systems have become widespread within industrial automation. IO-Link is an open-standard serial communication protocol that allows for the bi-directional exchange of data from sensors and devices that are connected to a master. The IO-Link master can transmit this data over various networks, fieldbuses, or backplane buses, making the data accessible for immediate action or long-term analysis via an industrial information system (PLC, HMI, etc.). Banner IO-Link products reduce wiring, increase data availability, enable remote configuration and monitoring, simplify device replacement, and provide extended diagnostics. Banner Engineering offers a variety of IO-Link products for industrial applications including sensors, lighting products, converters, hubs, and IO-Link masters.

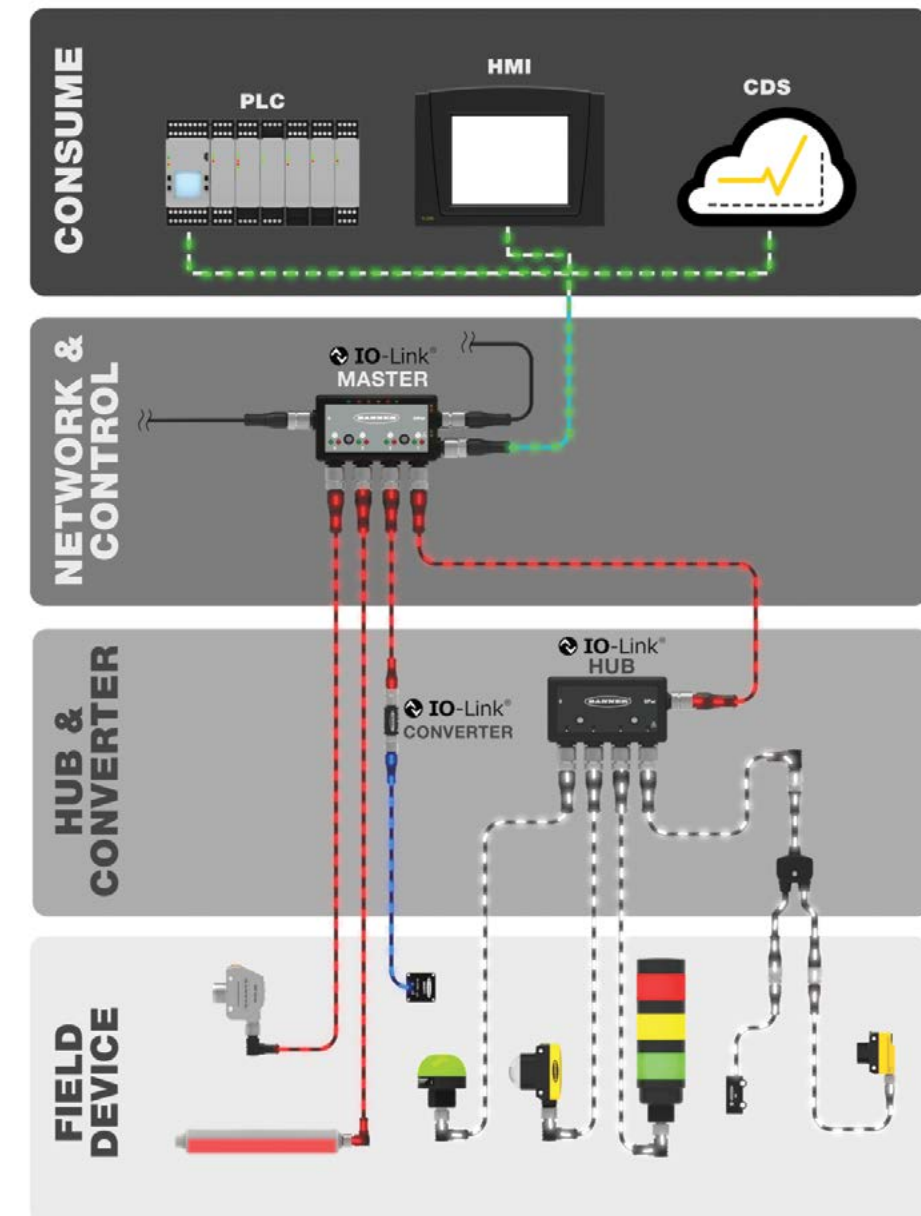



## DXMR110-8K IO-Link Master

- Local control or connectivity with automation protocols, including EtherNet/IP, Modbus/TCP, and PROFINET
- Logic processing and problem-solving capable of deploying solutions to process and control data from multiple devices
- IP67 housing simplifies installation in any location by eliminating the need for a control cabinet
- Consolidate cable runs to minimize cabling and associated weight, especially in weight-critical applications such as robotics
- Flexible and customizable—expanded internal logic controller with action rules and ScriptBasic programming
- For model information see page 72



## DXMR90-4K Four-Port IO-Link Masters with Ethernet

- Connects IO-Link devices to traditional PLC systems or sends data directly to the cloud
- Saves space and weight compared to traditional block-style form factors
- Rugged IP67/IP68 housing simplifies installation by eliminating the need for a control cabinet
- Communicates over EtherNet/IP, PROFINET, Modbus TCP, and Modbus RTU
- For model information see page 72

## Streamline Your IO-Link Network

The compact DXMR110-8K allows for the connection and control of up to eight IO-Link devices such as sensors, indicator lights, IO-Link hubs, and more. The DXMR110-8K can communicate with higher-level control systems via EtherNet/IP, Modbus/TCP, and PROFINET. The DXMR110-8K also has the ability to push IO-Link data to cloud platforms.

DXMR110-8K System Diagram

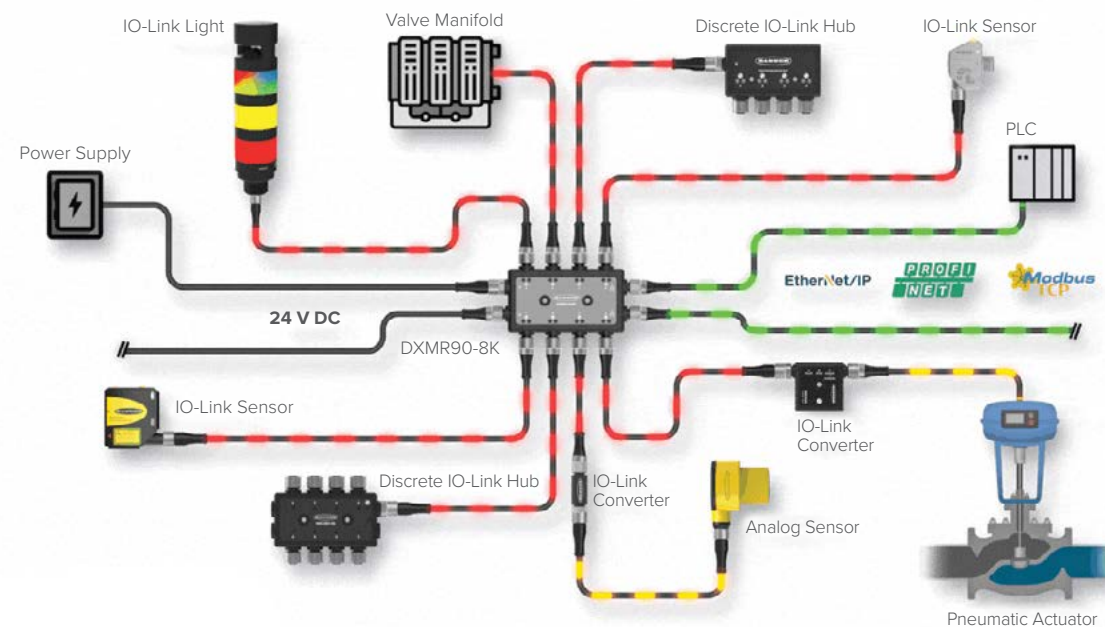

Configurable Modbus client port



Power/configurable Modbus port

- Power shared across all ports
- Modbus port can be client or server

Ethernet connection

- Rugged industrial-grade connector
- M12 D-code EtherNet/IP, PROFINET, and Modbus TCP

Four IO-Link Master ports

- Monitor or control nearly any IO-Link device



## R95C and R90C IO-Link Hubs

IO-Link hubs are a quick, easy, and economical way to integrate non-IO-Link devices into an IO-Link system.

- Eight- or four-port discrete PNP or NPN to IO-Link Hub
- Innovative form factor allows for use in areas with limited space
- Rugged design; easy installation requiring only minimal assembly or individual wiring
- Two configurable I/O pins per port support PNP or NPN inputs and outputs
- Uses industry-standard M12 connectors
- Compatible with any IO-Link Master
- For model information see page 72

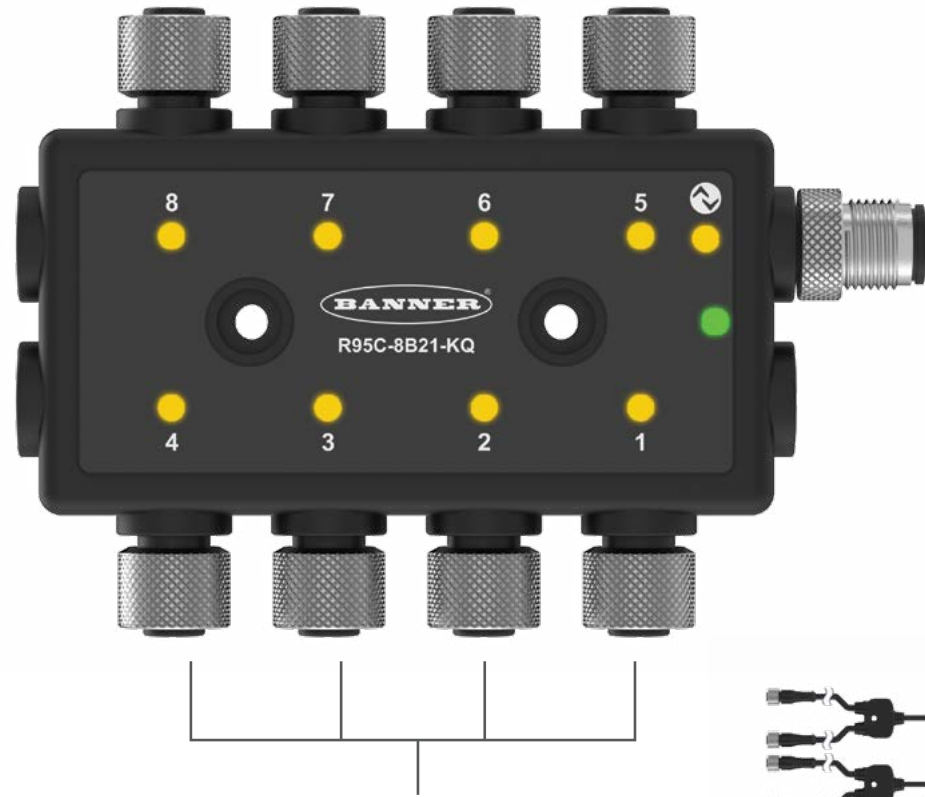

Power and IO-Link port  
 • Power shared across all ports

Eight ports individually configurable as either inputs or outputs  
 • Two I/O pins per port

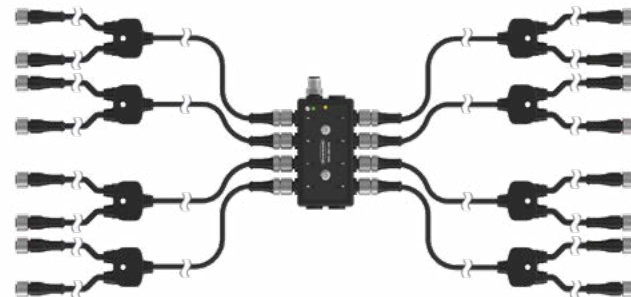

- Connections
- Connect up to two devices per port
  - Transmit up to sixteen discrete PNP or NPN input signals with one R95C hub
  - Drive discrete outputs on each port



## R45C IO-Link to Dual Analog Input-Output Converter

- Compact IO-Link device to analog converter that outputs an analog value, voltage, or current, as presented by the IO-Link Master
- The converter also connects to an analog source, voltage, or current, and outputs the value to the IO-Link Master and as a representative PFM output
- Rugged overmolded design meets IP65, IP67, and IP68 standards
- Connects directly to a sensor or anywhere in-line for ease of use
- For model information see page 73



## R45C IO-Link to Analog Converters

- Compact IO-Link to analog converters that output an analog value, voltage, or current, as presented by the IO-Link Master
- Rugged overmolded design meets IP65, IP67, and IP68 standards
- For model information see page 72



## Bring in IO-Link Sensor Data for Tank Level Applications Wirelessly

Combining Banner's serial IO-Link Masters and R70 serial data radios, IO-Link sensor data can be sent wirelessly. Using T30R IO-Link radar sensors, Banner's R90-4K-MQ IO-Link Master, R70 serial data radios, and the DXMR90 industrial controller, we can develop a wireless monitoring system for multiple tank level measurements that is easy to set up, interpret, and monitor locally and through a cloud-based system. This setup makes it easy to transmit IO-Link sensor data from remote clusters of IO-Link sensors. Information can be sent to the cloud where tank levels can be monitored over time and text and email alerts can be configured if tank levels fall below established thresholds. Data can also be sent directly to a PLC or SCADA via Modbus TCP, EtherNet/IP, and PROFINET.



## R70 Series Data Radios

- Compact, low-power industrial wireless communication devices used to extend the range of serial communication networks
- Star or tree network topology configuration
- DIP switches select operational modes
- Frequency Hopping Spread Spectrum (FHSS) technology ensures reliable data delivery
- Self-healing, auto-routing radio frequency network with multiple hops to extend the network's range
- For model information see page 73

### Reliably Transmit Data

- Data can be transmitted over great distances and around obstacles
- Extends the range of serial networks with wireless nodes to replace cable runs
- Combines wired and wireless technology for flexible predictive maintenance solutions
- DIP-switch configuration makes installation simple and fast



### Point to point Networks



### Tree Networks

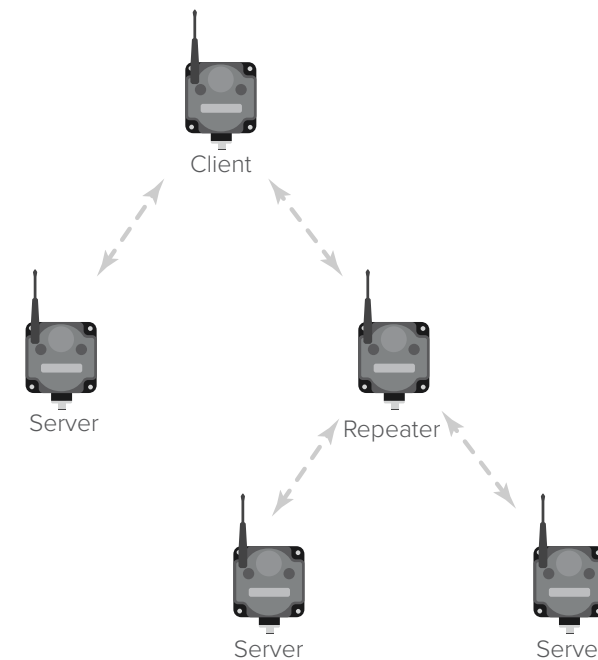

### Star Networks

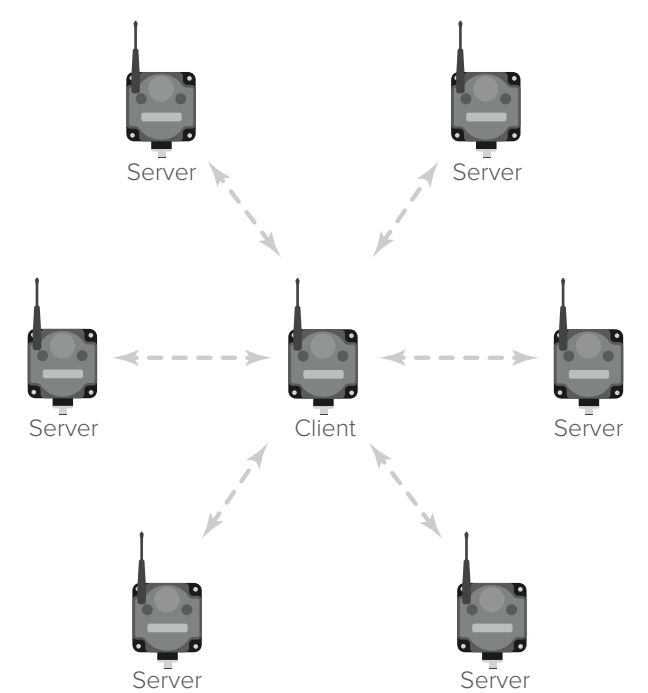

### I/O Serial Data Radios

- Available in two frequencies: 900 MHz and 2.4 GHz
- RS-485 serial communication

### Ethernet Data Radios

- Simple Ethernet cable replacement makes it possible to connect devices to switches and PLCs across long distances
- Advanced Encryption Standard (AES) using a 256-bit cryptographic key
- Also available in 900 MHz and 2.4 GHz

# Banner Cloud ID™ Kits

## Validate with Data. Provide Savings. Increase Value.

- Products with proven wireless communication and integrated Ethernet or cellular connectivity
- Automatic dashboards and default alarms assist in data-driven decisions and solutions
- Customizable solutions with the battery-powered Q45 nodes for convenient installation and adaptability
- Durable IP-rated gateway and accessories included; wireless sensor nodes are sold separately
- Up to 40 sensor nodes to scale and adapt solutions for specific needs
- For model information see page 73



## Q45 Series

### Wireless Sensors

- All-in-one design eliminates the time, labor, and expense of installing separate sensors and nodes
- Use with Cloud ID Kits and Cloud Data Services software to create an end-to-end IIoT solution that will help you identify and resolve problems more quickly and make better, data-driven decisions
- For model information see page 74

## Q45 All-in-One Series for Predictive Maintenance

Q45 Series all-in-one devices combine a wireless node, a sensor, and a battery power supply. These easy-to-deploy units monitor assets and equipment in remote, hard-to-access locations. For model information see page 74.



The Q45DT all-in-one wireless dual thermistor node measures two separate thermistors and the differential for air and liquid handling applications



The Q45CT all-in-one current transformer and wireless node measures current draw, helping to reveal issues with critical motor performance



The Q45VAC all-in-one vibration and temperature sensor and wireless node monitors the health and performance of motors, pumps, and similar equipment with rotating motion; mounting kit with magnetic and non-magnetic brackets available



The Q45UA all-in-one ultrasonic sensor and wireless node monitors the level or position of fluid or dry assets in tanks, totes, and containers



The Q45TA all-in-one thermistor node measures temperature in key areas or processes



The Q45THA all-in-one temperature, humidity, and wireless node monitors environmental conditions in a variety of applications

## Q45 Nodes for Predictive Maintenance

Q45 Series 1-wire serial nodes are preconfigured to work with Banner's 1-wire serial sensors, simplifying setup and deployment. This variety of compact sensors with integrated lithium batteries makes remote monitoring easy. For model information see page 74.



The Q45VTPD works with the QM30VT1 Vibration and Temperature Sensor to monitor a variety of vibration characteristics on rotating equipment for preventative maintenance applications.



The wireless Q45UPSD pressure monitoring node and cabled BWA pressure sensor accessories monitor pressurized systems in remote locations without human intervention.



The Q45U connects directly to a variety of sensors such as QM30VT1 (vibration), K50UX1CRA (tank level), or M12FTH4Q (humidity) to monitor environmental conditions in a broad range of applications.



The Q45DPSD uses a the QM42-DPS Differential Pressure Sensor to measure low pressure systems and filter health.



## Connectivity

Whether you are making standard connections or updating your industrial system, Banner's connectivity technologies will ensure you get the signal you need, where you need it, quickly and reliably.



### Molded Junction Blocks

Streamline device access for functional checks, maintenance, service, and replacement. Molded junction blocks easily consolidate wires from different sources into one convenient, customized central hub. They can be installed in extremely wet, dusty, hot, or cold environments by virtue of their compact, overmolded design.



### S15L In-Line Sensor Status Indicator

The S15L in-line sensor status indicator is an ideal accessory in industries that require highly visible indication, such as automotive, material handling, and general assembly.



### S15A Wiring Adapters

S15A in-line wiring adapters are small, plug-in accessories designed to connect directly to a sensor, indicator, or other device to redirect wiring for any function, operation, or utilization.



### CSB Splitters

Used to power multiple devices with one cable.



### S15Y Splitters

M12 quick-disconnect splitter cables are used to make cables more versatile in applications.



## R95 and R50 Molded Junction Blocks

Streamline device access for functional checks, maintenance, service, and replacement. Molded junction blocks easily consolidate wires from different sources into one convenient, customized central hub. They can be installed in extremely wet, dusty, hot, or cold environments by virtue of their compact, overmolded design.

- Conjoin multiple devices into one connector
- Easy installation with no assembly or individual wiring required
- 5-pin M12 male quick-disconnect homerun connector
- Multiple 5-pin M12 female quick-disconnect connectors
- Rugged overmolded design meets IP65, IP67, and IP68 standards
- For model information see page 70



### S15L In-Line Sensor Status Indicator

- Two-color indicators available with green to show power and yellow or red to mimic the output status
- Mount directly on a sensor for 360 degree-visibility of power and status
- Highly-visible body allows workers to identify and troubleshoot problems faster
- Over-molded design is reliable and rugged to withstand harsh industrial environments
- Models available with PNP or NPN inputs
- For model information see page 70

### S15A Wiring Adapters

- Adapters re-route wiring to match specific application requirements
- Matches outputs to inputs and isolates select signals
- Rugged, overmolded design meets IP65, IP67, and IP68 standards
- Simple M12 connection for easy installation where needed in the circuit
- Custom options are available
- For model information see page 72



### CSB Splitters

- Splits into two connectors
- Male M12 trunk, female M12 branches
- For model information see page 71

### S15Y Splitters

- Male M12 trunk, female M12 branches
- 0.2 m leads extending from overmold
- Parallel and standard options available for different devices
- For model information see page 71

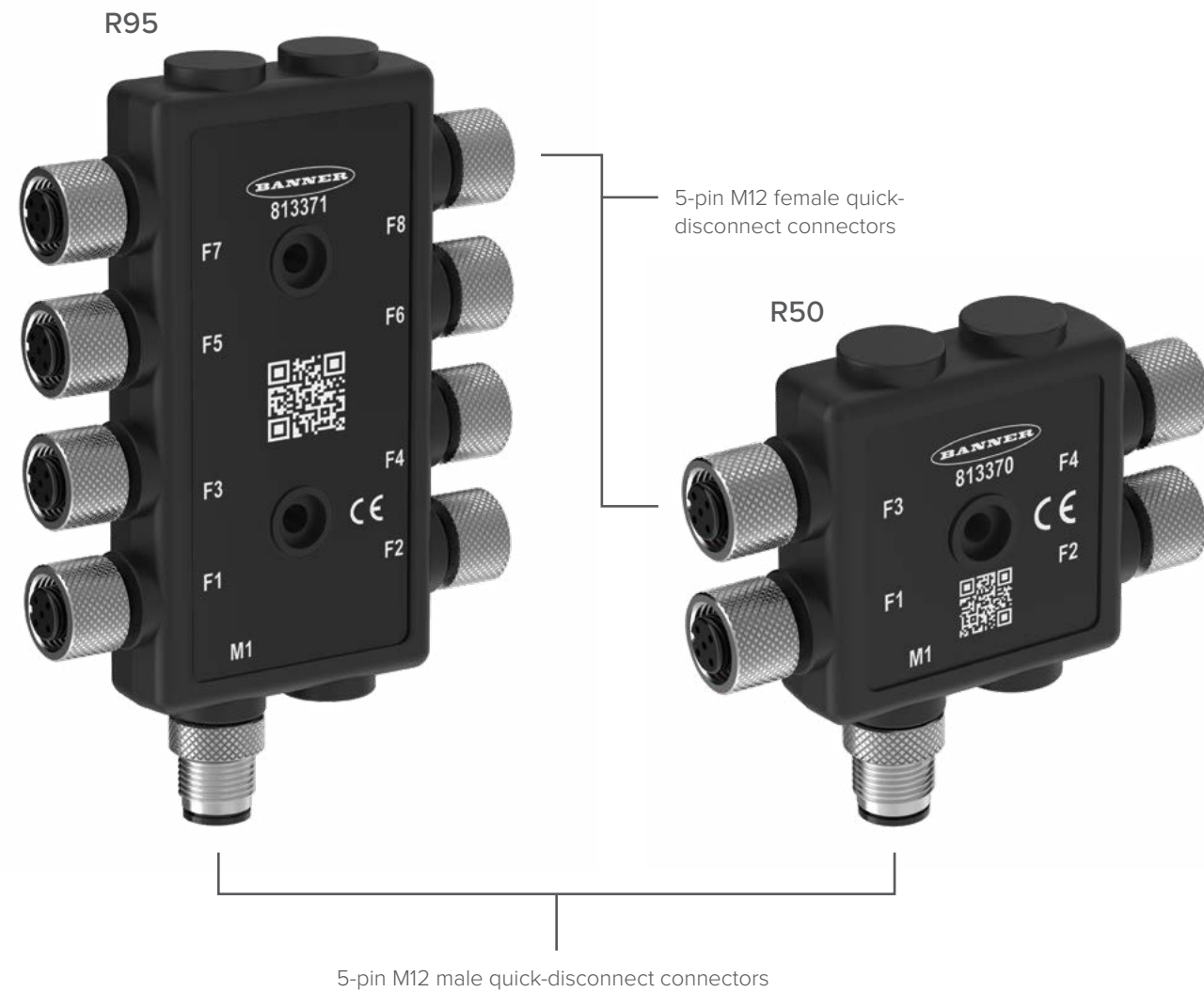

# Sensors

## Q2X Miniature Sensors

### Polarized Retro and Opposed

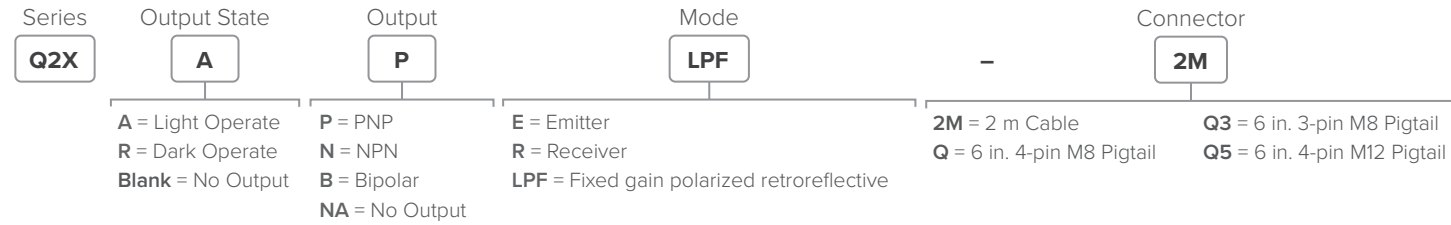

### Adjustable-Field

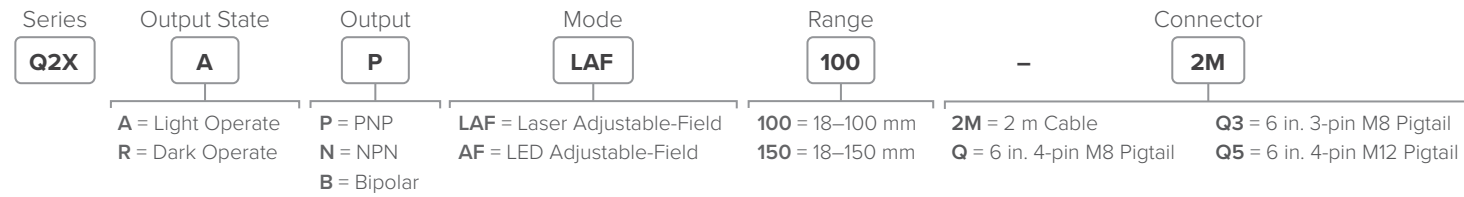

## Q20-2 Compact Sensors

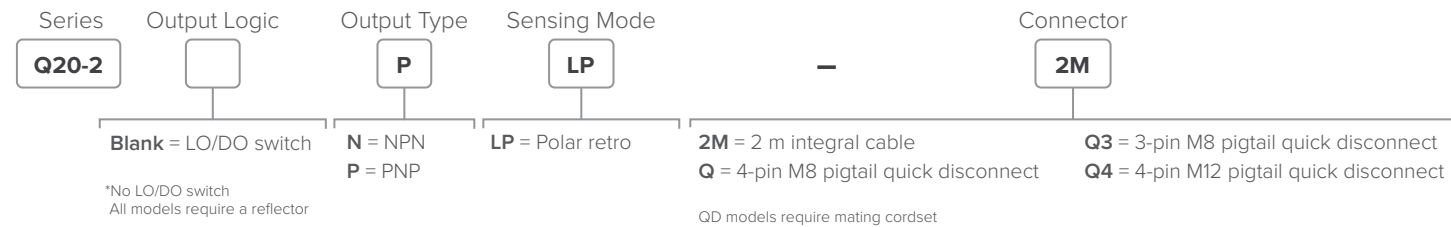

## Q5X Laser Measurement Sensors

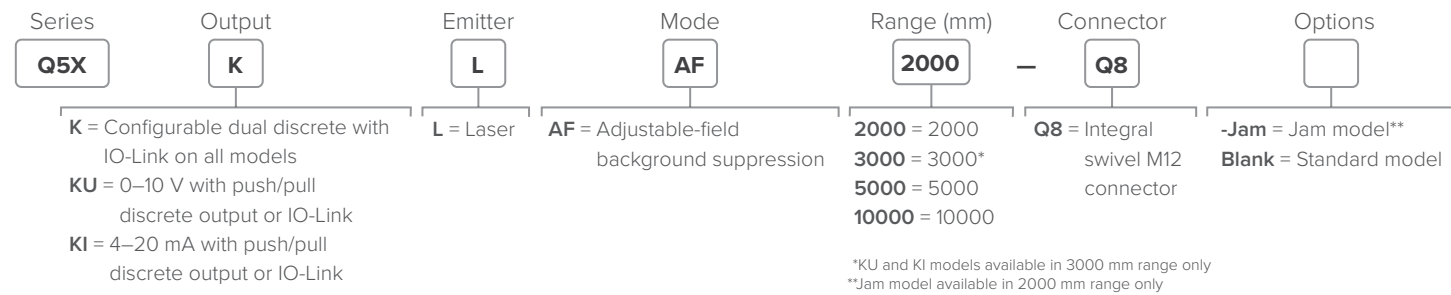

## Q5Z Laser Measurement Sensors

Emitter	Range	Mode	Output	Connector	Model
Laser	1800 mm	Adjustable-field background suppression	Configurable dual discrete with IO-Link	Integral swivel M12	<b>Q5ZKLA1800-Q8</b>

Note: The Q5Z Laser Measurement Sensor is a Class 2 laser sensor with IO-Link and a multifunction output. The single teach button and no display mean the sensor must be configured at the factory. This is so that it is ready for installation out of the box. To customize the configuration for an application, contact Banner Engineering.

## T30R Radar Sensors

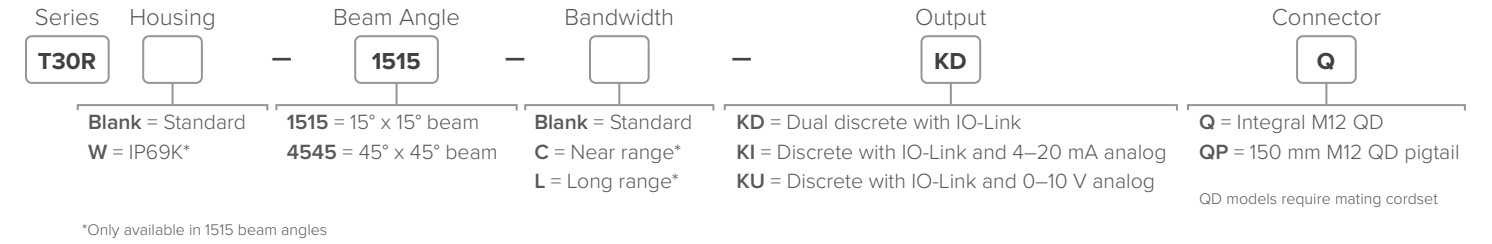

## K50R Radar Sensors

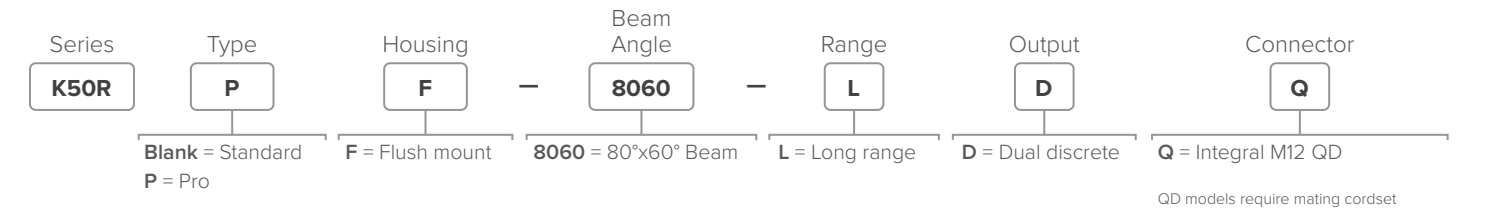

## ZMX 3D Time of Flight Sensors

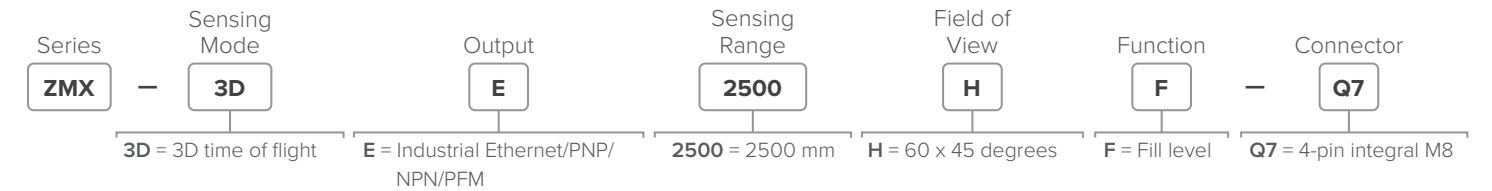



# Machine Safety

## SC10 Safety Controllers

Housing H x W x D	Inputs/Convertible	Independently Controlled Safe Outputs	Maximum Safety Output Rating	Features	Models
115 x 45 x 100 mm	10/4	2 Dual Channel Relays	2x 3 NO: 6A 250 V AC/24 V DC	ISD, Ethernet	<b>SC10-2roe</b>

## XS26-ISDd Expandable Safety Controllers

Housing H x W x D	Inputs/Convertible	Independently Controlled Safe Outputs	Maximum Safety Output Rating	Features	Models
110 x 45 x 128 mm	26/8	2 Dual Channel PNP	0.5A at 24 V DC	ISD	<b>XS26-ISDd</b>

## SI-RF Safety Switches

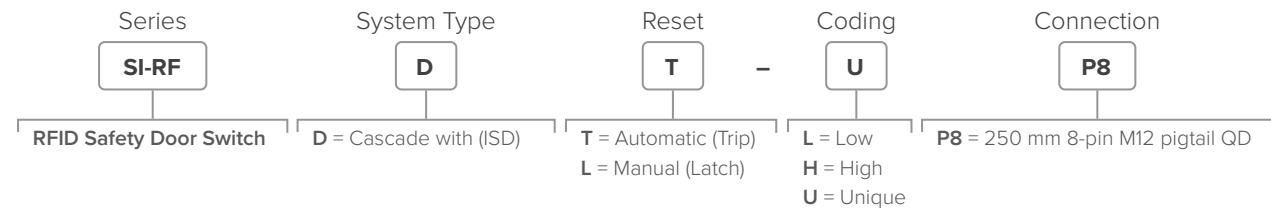

## S4B Safety Light Curtains

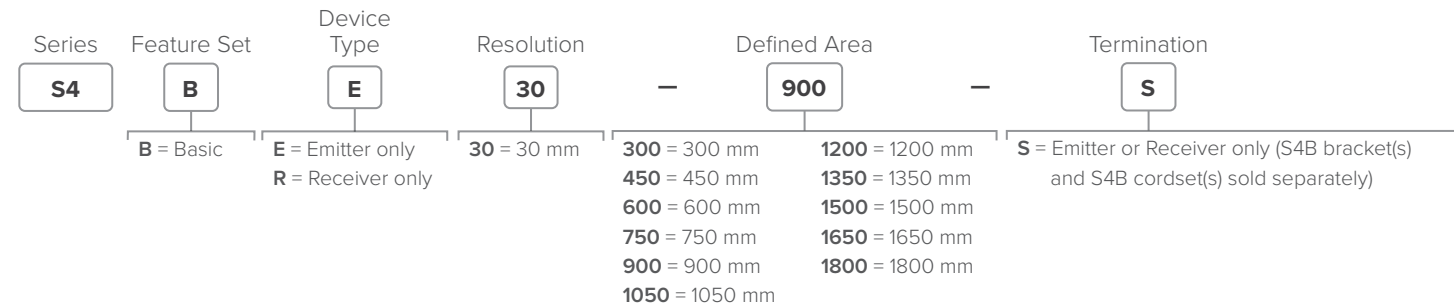

## SI-GL42 Safety Locking Switches

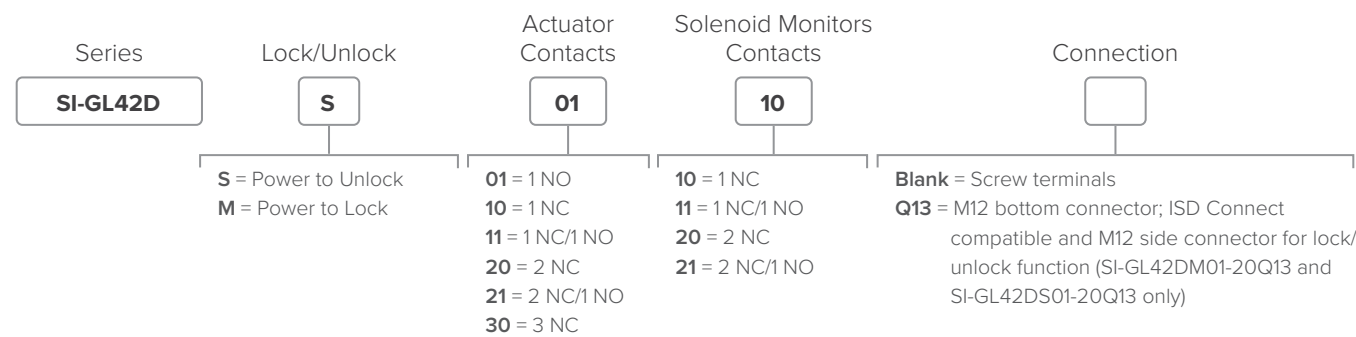

## Illuminated E-Stops

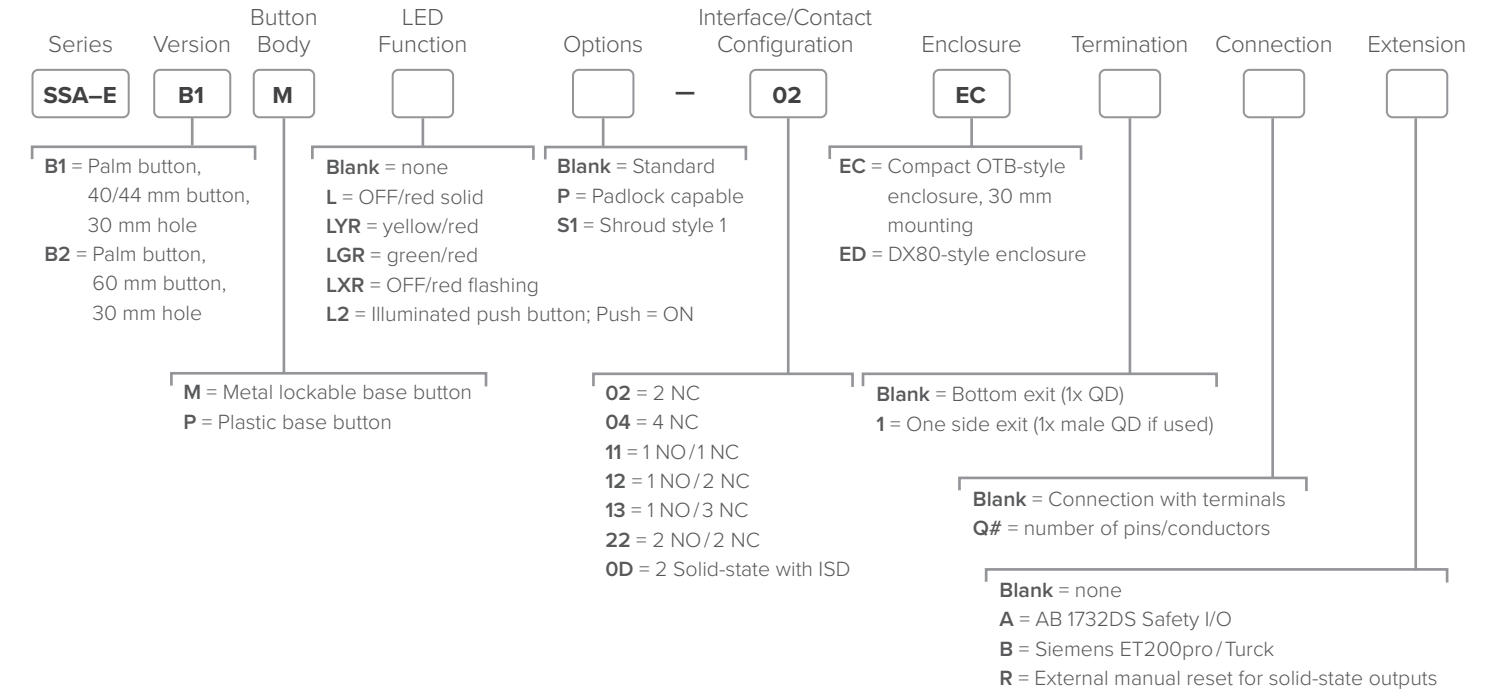

## ISD Connect

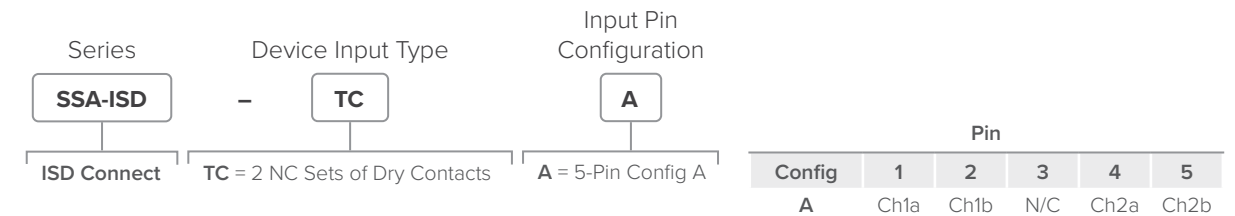

## SX5 Laser Scanners

Housing H x W x D	Range	Max Zone Sets	Master Remote	Models
152 x 102 x 112 mm	30 mm = 2.5 m	6		<b>SX5-B6</b>
	40 mm = 3 m	10	Master	<b>SX5-M10</b>
	50 mm = 4 m	70	Master	<b>SX5-M70</b>
	70/150 mm = 5.5 m	70	Master	<b>SX5-ME70</b>
		Depends on master		Remote

# Lighting and Indication

## HLS27 Hazardous Location LED Strip Lights

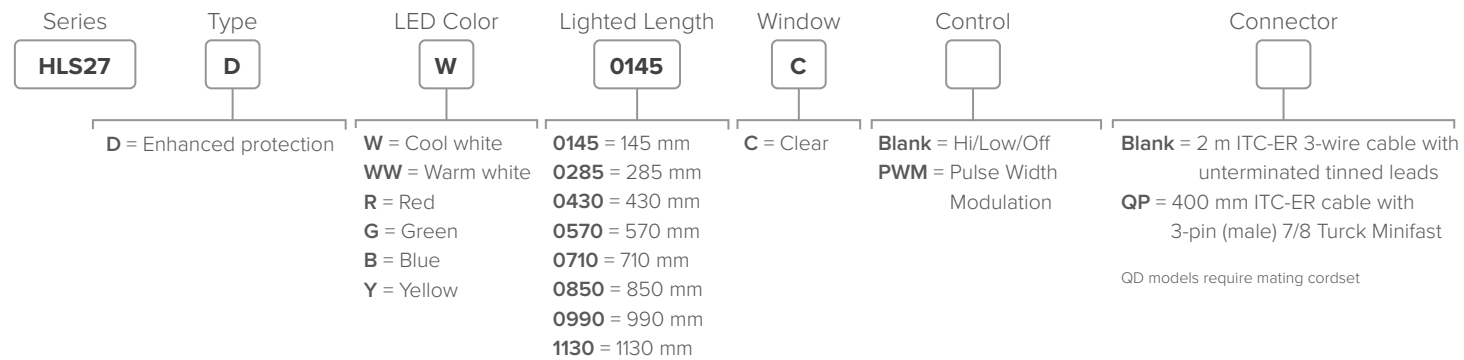

## HLS28 Hazardous Enclosure LED Strip Lights

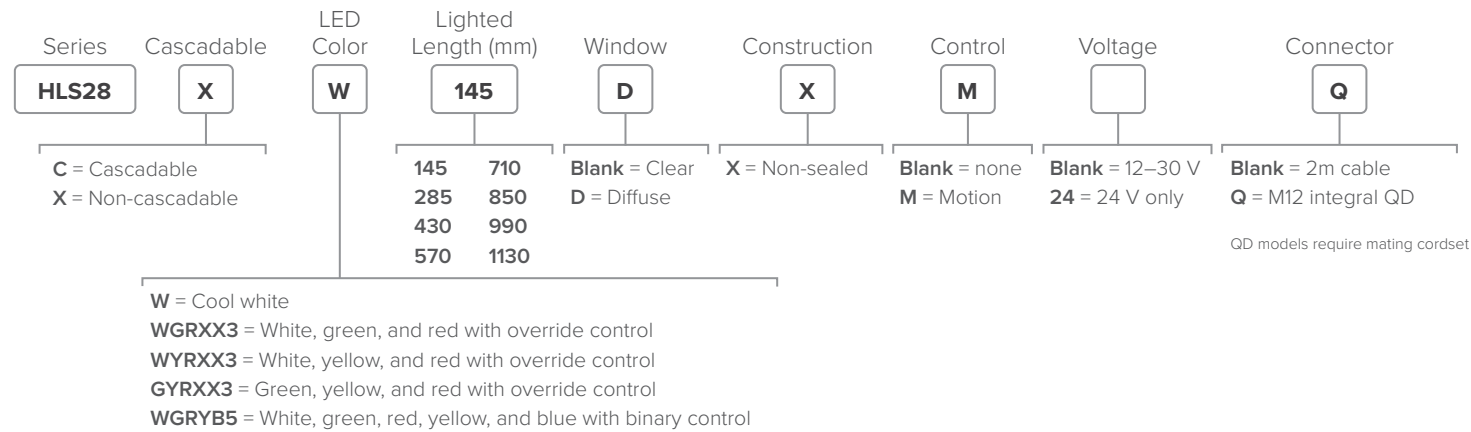

## WLA-2 Industrial LED Area Lights

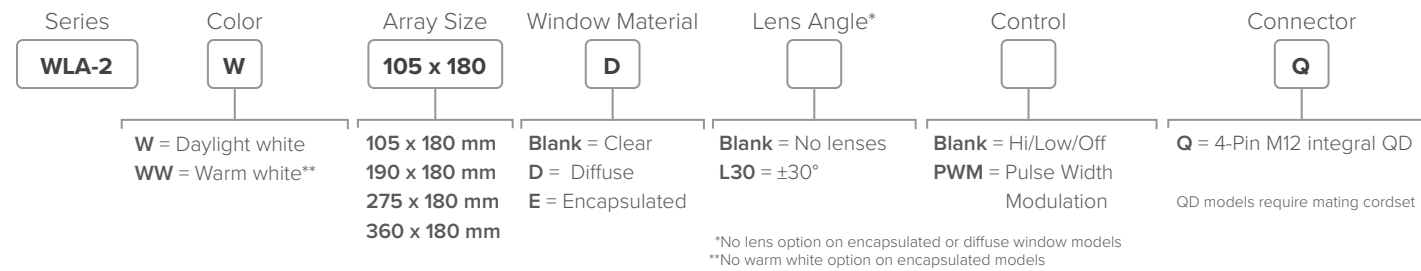

## K30 and K50 Hazardous Area Indicators

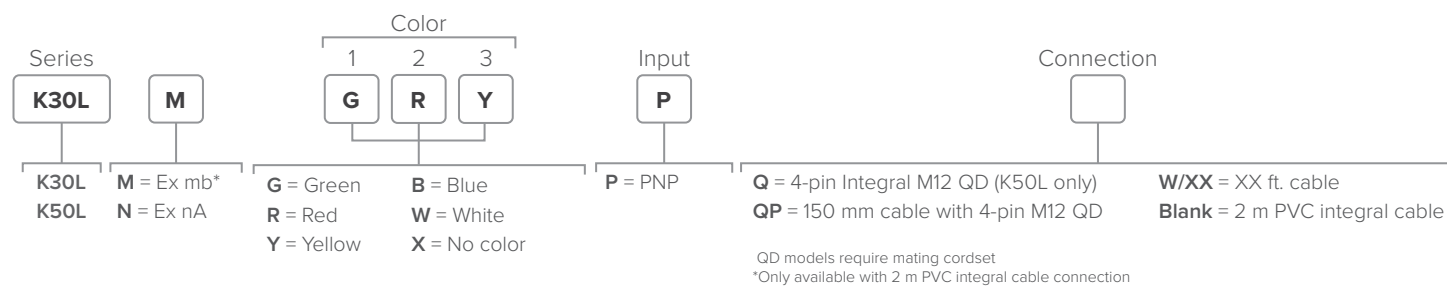

## TL15 In-Line Modular Tower Lights

Color (Input Active Pin)	Models	Color (Input Active Pin)	Models
Green (pin 4)	TL15G4Q	Red (pin 1)	TL15R1Q
Yellow (pin 1)	TL15Y1Q	Red (pin 4)	TL15R4Q
Red (pin 2)	TL15R2Q	Green (pin 4), yellow (pin 1), red (pin 2)	TL15GYRQ
Blue (pin 4)	TL15B4Q	Blue (pin 4), green (pin 1), yellow (pin 2), red (pin 5)	TL15BGYRQ
Green (pin 1)	TL15G1Q	Audible, no color (pin 5)	TL15A5Q
Yellow (pin 2)	TL15Y2Q	Audible, no color (pin 1)	TL15A1Q
Red (pin 5)	TL15R5Q	Audible, no color (pin 2)	TL15A2Q

## K30 Pro Optical Sensors

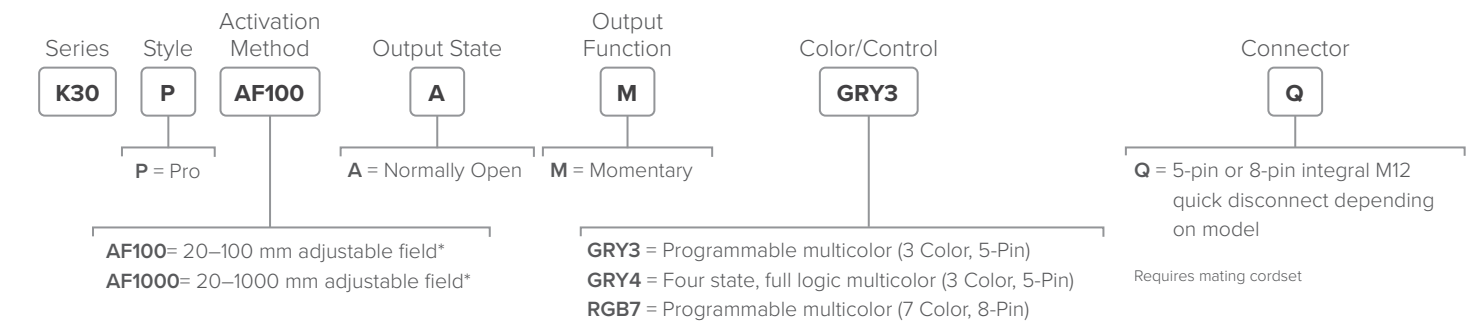

\*Detection distance can be adjusted through teach mode or Pro Editor. Max distance = 1000 mm.

## K50 Pro Touch with Display

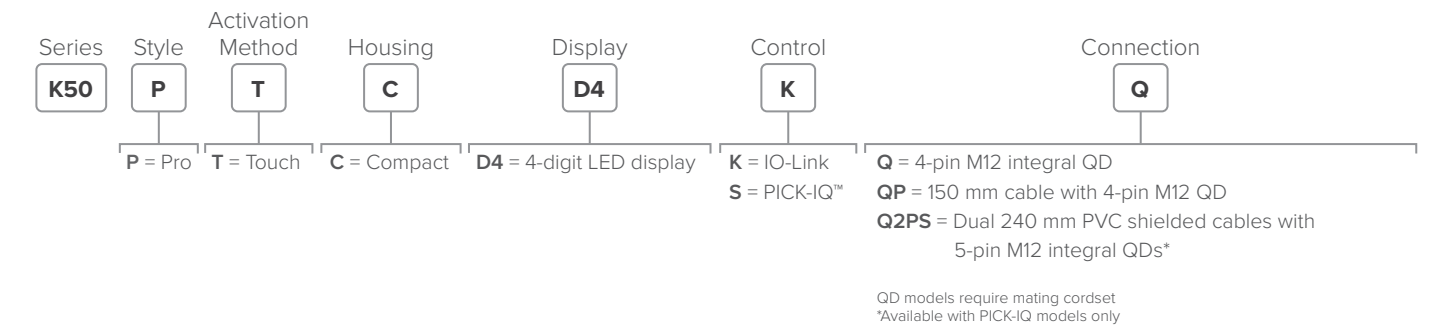

## K50 Pro with Audible

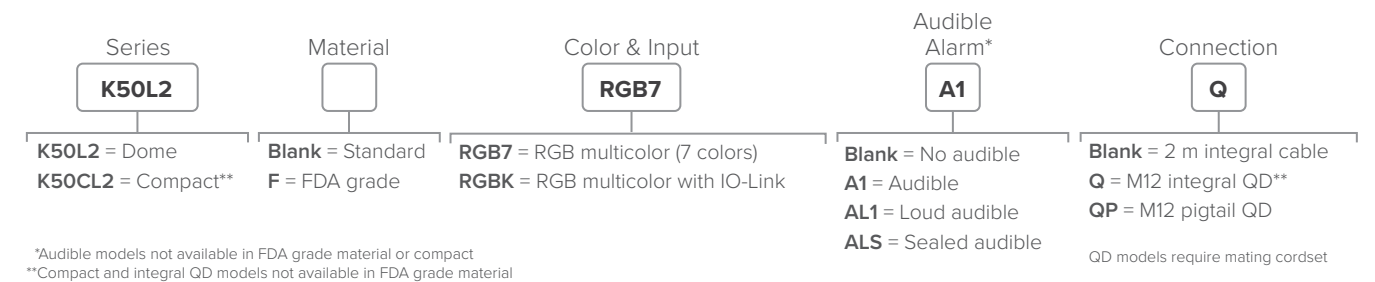

# Lighting and Indication

## K50 Pro Touch with Audible

### Pro Models

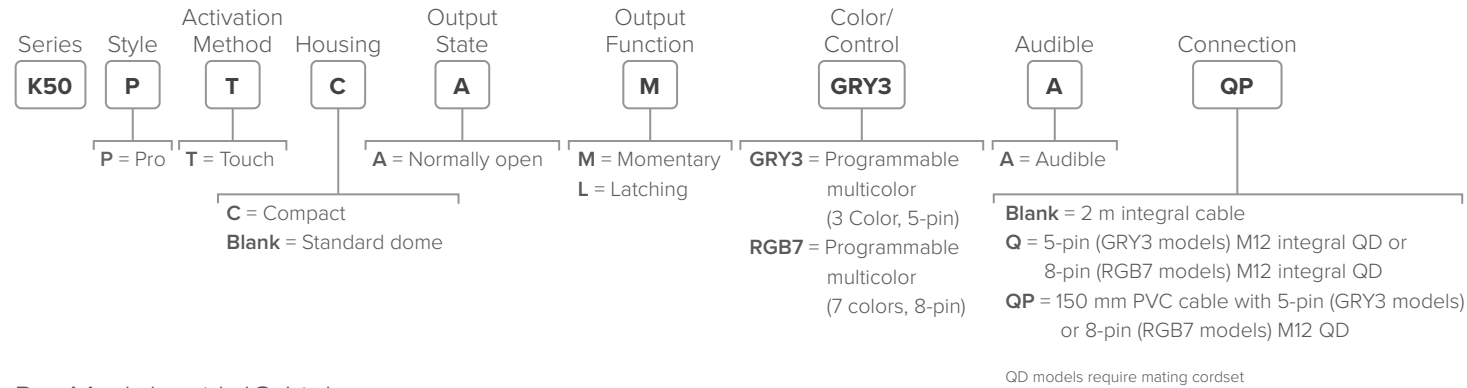

### Pro Models with IO-Link

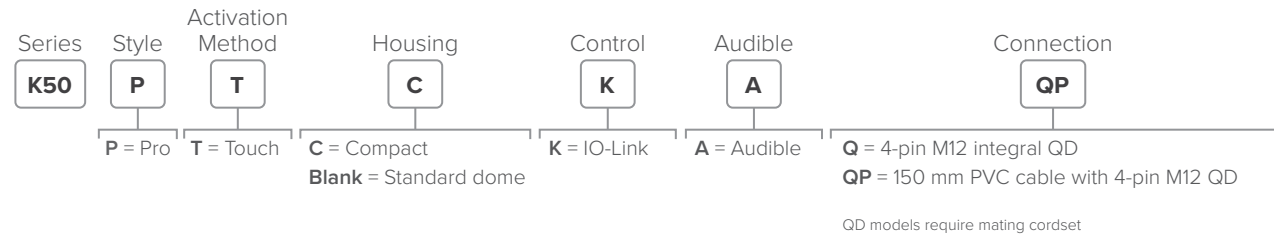

## K70 Pro Touch Indicators

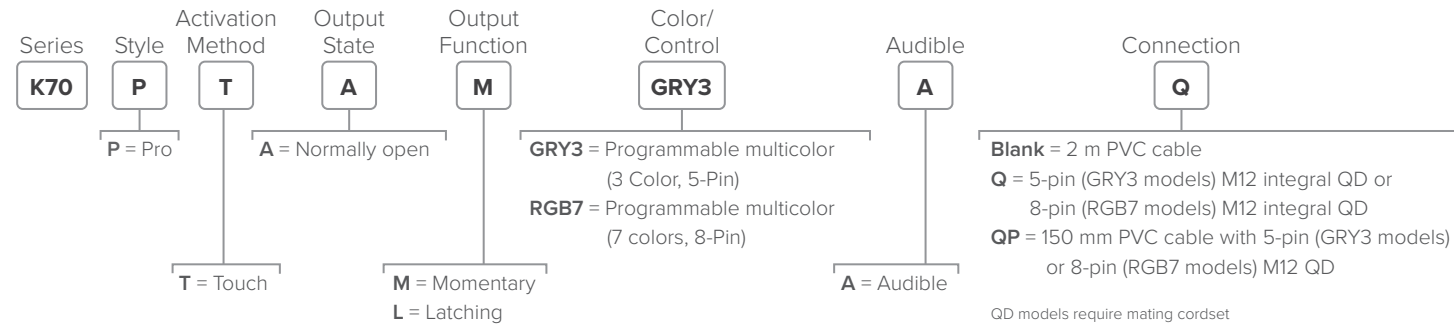

## CL50 Pro Column Lights

### Pro Models

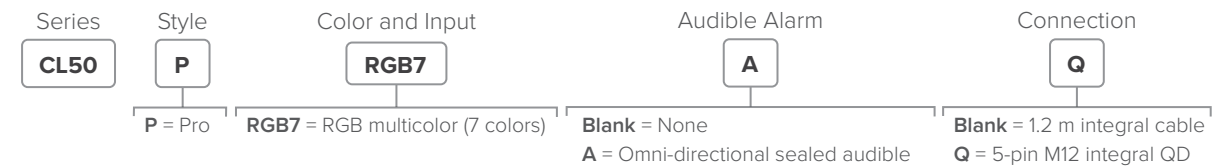

### Pro Models with IO-Link

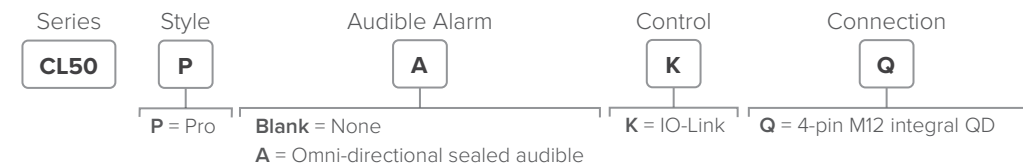

## K100 Pro Indicators

### Pro Models



## Pro Hazardous Indicator Beacon

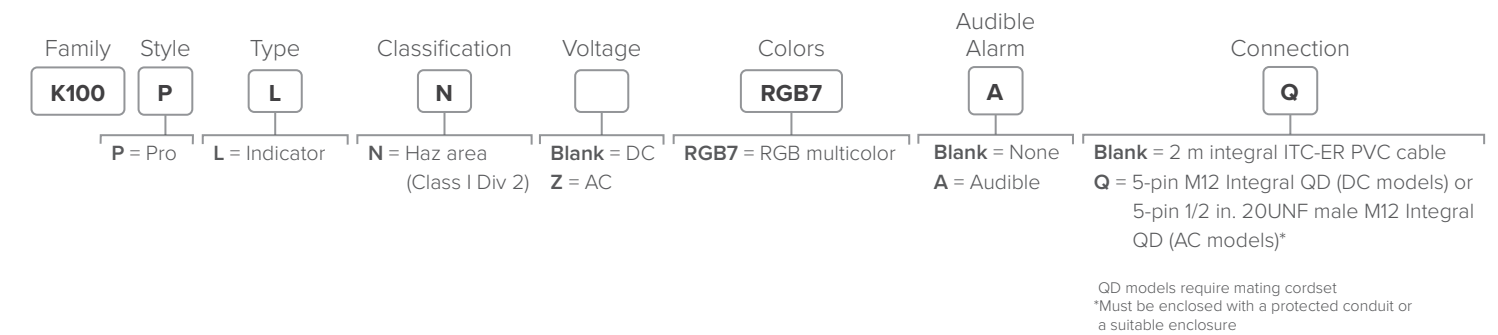

## TLF100 Pro Flush Mount Tower Lights

### Pro Models

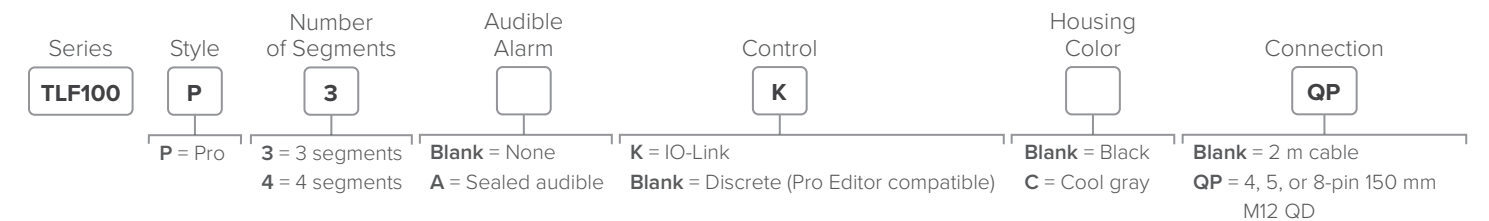

## Pro Daylight Visible Models

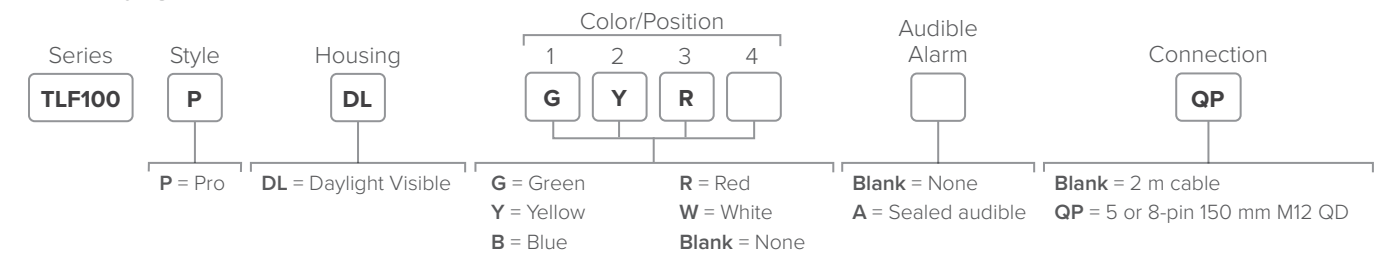

# Connectivity

## R95 and R50 Molded Junction Blocks

Description	Branch Cable Lengths (Female)	Trunk Cable Length (Male)	Models
5-Pin	4 x Integral branch	Integral trunk	R50-4M125-M125Q-P
	8 x Integral branch	Integral trunk	R95-8M125-M125Q-P

## S15A Wiring Adapters

Function Description	Models	Function Description	Models
Pin 2 goes to Pin 4 in both directions	S15A-F14325-M14325-Q	Pin 1 is open; all others pass through	S15A-FX2345-MX2345-Q
Female Pin 4 goes to Male Pin 5	S15A-F1235X-M123X4-Q	Pin 2 is open; all others pass through	S15A-F1X345-M1X345-Q
Female Pin 2 goes to Male Pin 5	S15A-F1534X-M1X342-Q		

## S15L In-Line Sensor Status Indicators

Power ON (Color 1)	Input Active (Color 2)	Input Type	Connection	Models
Green	Yellow	PNP	4-pin male/female M12 quick disconnect	S15LGYPQ
		NPN		S15LGYNQ
	Red	PNP		S15LGRPQ
		NPN		S15LGRNQ
Red	Green	PNP	S15LRGPQ	
Yellow		PNP	S15LYGPQ	
Green	Yellow	PNP	3-pin male/female M12 quick disconnect	S15LGYPM8Q3
		NPN		S15LGYNM8Q3
	Red	PNP		S15LGRPM8Q3
		NPN		S15LGRNM8Q3

## CSB Splitters

Description	Branch Cable Lengths	Trunk Cable Length	Models
4-pin	2 x Integral branch (female)	Integral trunk (male)	CSB-M1240M1240
	2 x 0.3 m (female)	Integral trunk (male)	CSB-M1240M1241
	2 x 0.3 m (female)	0.3 m (male)	CSB-M1241M1241

## S15Y Splitters

Description	Cable Lengths		Wiring Diagrams	Models
	Branches (Female)	Trunk (Male)		
4-Pin	2 x 0.2 m	Integral trunk		S15YB-M124-M124-0.2M
				S15YA4-M124-M124-0.2M
				S15YA24-M124-M124-0.2M

# Industrial Wireless

## DXMR90 Controllers

Ethernet Connection	Master Connections	Other Connections	Models
One female M12 D-code Ethernet connector	Four female M12 connections for Modbus Four female M12 connections for IO-Link	One male M12 (Port 0) for incoming power and Modbus RS-485, one female M12 for daisy chaining Port 0 signals One male M12 (Port 0) for incoming power	<b>DXMR90-X1</b> <b>DXMR90-4K</b>

## R45C and R90C IO-Link Masters

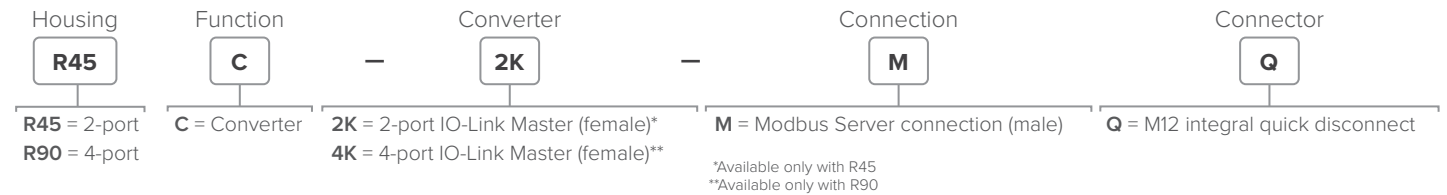

## R45C IO-Link to Analog Converters

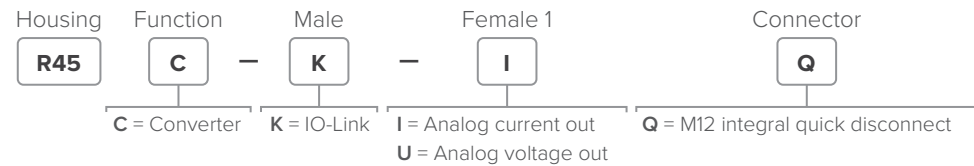

## R90C and R95C IO-Link Hubs

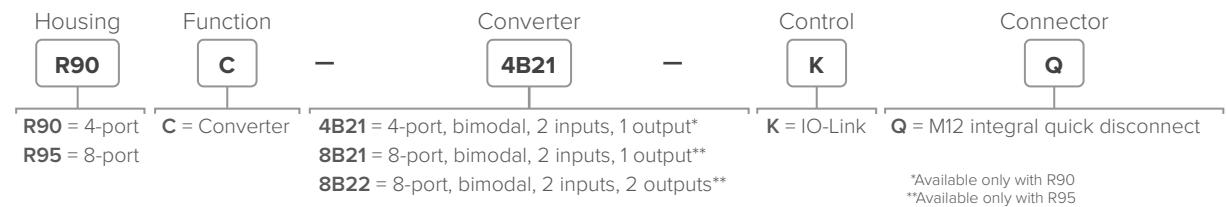

## IO-Link S15C Converters

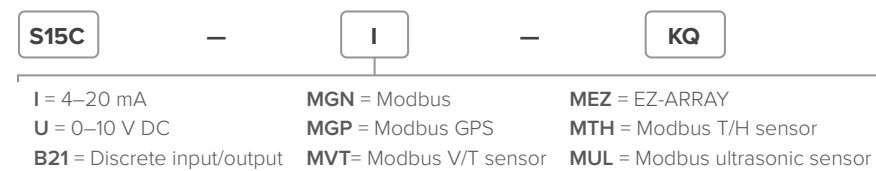

## S15S Infrared Temperature Sensors

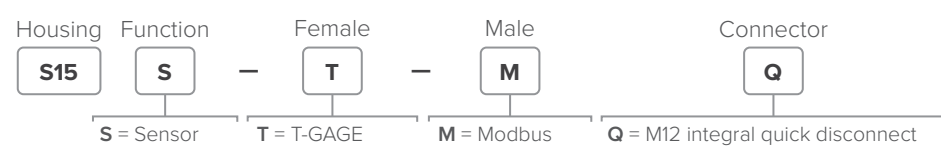

## DXMR110-8K IO-Link Masters

Ethernet Connection	IO-Link Master Connections	Other Connections	Models
Two female M12 D-Code Ethernet connectors for daisy chaining and communication to a higher-level control system	Eight female M12 connections for IO-Link	One male M12 for incoming power, one female M12 for daisy chaining power	<b>DXMR110-8K</b>

## Modbus S15C Converters

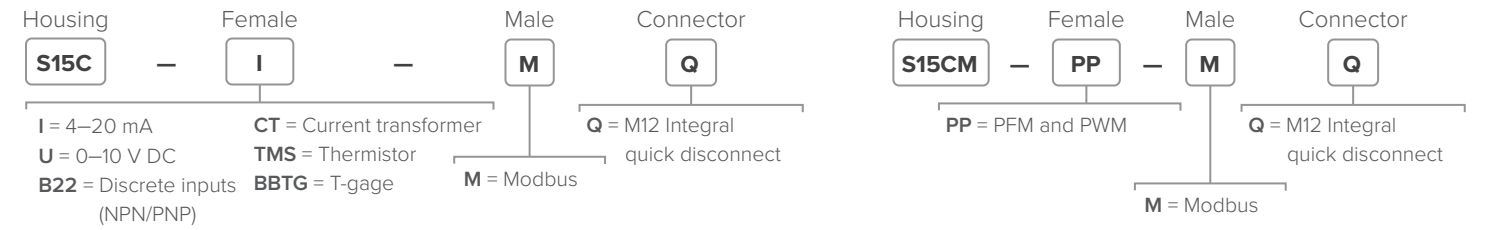

## R95C Discrete Bimodal to Modbus Hubs



## R90C Modbus to Analog Hubs



## R45C IO-Link to Dual Analog Input-Output Converters

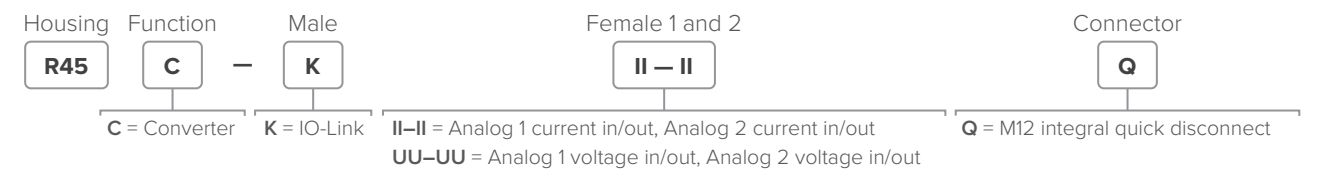

## S15S Temperature and Humidity Sensors

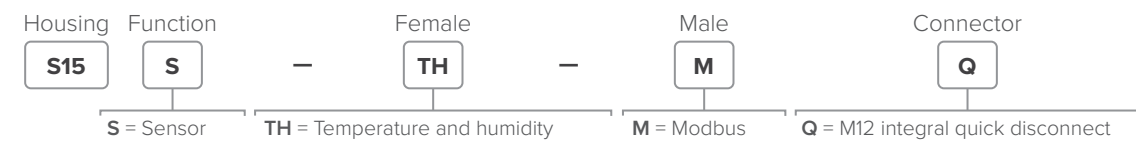

## R70 Data Radios

Communication Type	Frequency	Transmit Power	Models
Serial	900 MHz ISM band	1 Watt	<b>R70SR9MQ</b>
	2.4 GHz ISM band	65 mW (100 mW EIRP)	<b>R70SR2MQ</b>
Ethernet	900 MHz ISM band	500 mW	<b>R70ER9MQ</b>
	2.4 GHz ISM band	65 mW (100 mW EIRP)	<b>R70ER2MQ</b>

## Banner Cloud ID™ Kits

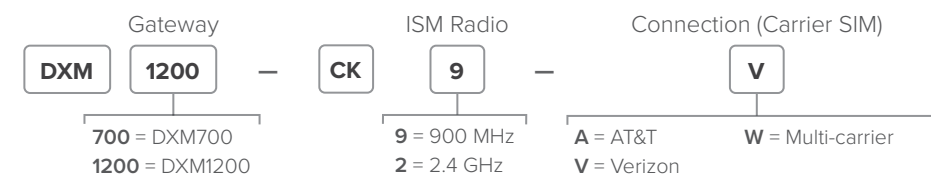

# Industrial Wireless

## Q45 Wireless Sensors and Nodes

### All-in-One Vibration Sensor Nodes

Vibration and temperature sensors that monitor the health and performance of motors, pumps, and similar equipment with rotating motion; mounting kits with magnetic and non-magnetic brackets are available

Radio Frequency	Power Supply	Inputs	Models
900 MHz ISM band	C cell lithium battery	Vibration and temperature detection	DX80N9Q45VAC
2.4 GHz ISM band			DX80N2Q45VAC

### Wireless Nodes and Compact Vibration Sensors (must be purchased together)

Communication	Radio Frequency	Power Supply	Inputs	Models
ISM radio band	900 MHz	D cell lithium battery	Vibration and temperature detection	DX80N9Q45VTPD
	2.4 GHz			DX80N2Q45VTPD
1-wire serial	–	–	–	QM30VT1 QM30VT1-SS*

\*316 Stainless Steel Model

### All-in-One Temperature and Humidity Sensor Nodes

Temperature and humidity wireless node monitors environmental conditions in a variety of applications, such as refrigerators or chillers, warehouses, cleanrooms, incubators, storage rooms, and distribution centers

Radio Frequency	Measurement Range	Inputs	Models
900 MHz ISM band	-40 to +85 °C (-40 to +185 °F) 0 to 100% relative humidity	Temperature and relative humidity (%)	DX80N9Q45THA
2.4 GHz ISM band			DX80N2Q45THA

### All-in-One Temperature Probe Sensor Nodes

Thermistor nodes measure temperature in key areas or processes like air- and liquid- handling applications

Radio Frequency	Measurement Range	Inputs	Models
900 MHz ISM band	-20 to +105 °C (-4 to +221 °F)	Temperature	DX80N9Q45TA
2.4 GHz ISM band			DX80N2Q45TA

### All-in-One Dual Temperature Probe Sensor Nodes

Radio Frequency	Measurement Range	Inputs	Models
900 MHz ISM band	-20 to +105 °C (-4 to +221 °F)	Temperature	DX80N9Q45DT
2.4 GHz ISM band			DX80N2Q45DT

### 1-Wire Serial Interface Nodes

Radio Frequency	Power Supply	Description	Models
900 MHz ISM band	Integrated battery	Must be paired with a 1-wire serial interface sensor (sold separately)	DX80N9Q45U
2.4 GHz ISM band			DX80N2Q45U

### All-in-One Ultrasonic Sensor Nodes

Ultrasonic sensor nodes monitor the level or position of fluid or dry assets in tanks, totes, and containers

Radio Frequency	Ultrasonic input Range and Frequency	Inputs	Models
900 MHz ISM band	Range: 100 mm to 1 m (3.94 in to 39.4 in) Frequency: 240 kHz	One ultrasonic input One thermistor input	DX80N9Q45UAA
2.4 GHz ISM band			DX80N2Q45UAA
900 MHz ISM band	Range: 300 mm to 3 m (11.8 in to 118 in) Frequency: 114 kHz		DX80N9Q45UAC
2.4 GHz ISM band			DX80N2Q45UAC

### Wireless Nodes and Quick-Disconnect Pressure Sensors (must be purchased together)

Wireless node and pressure transducer accessories measure air, gas, and fluid pressure of systems and equipment

Communication	Pressure Range	Inputs	Models
900 MHz ISM frequency band	Universal	Pressure	DX80N9Q45UPSD
2.4 GHz ISM frequency band			DX80N2Q45UPSD
Analog voltage	0–50 PSI		BWA-PRESSURE-SENSOR-50
	0–150 PSI		BWA-PRESSURE-SENSOR-150
	0–500 PSI	BWA-PRESSURE-SENSOR-500	
	0–3000 PSI	BWA-PRESSURE-SENSOR-3000	

### Wireless Nodes and Quick-Disconnect Differential Pressure Sensors (must be purchased together)

Wireless node and differential-pressure accessories provide the ability to monitor low-pressure applications such as filter and vacuum lines, HVAC and duct pressure, dust collectors, clean rooms, fume hoods, and air flow

Communication	Pressure Range	Inputs	Models
900 MHz ISM frequency band	Universal	Low-pressure differential sensor	DX80N9Q45DPSD
2.4 GHz ISM frequency band			DX80N2Q45DPSD
1-wire serial	±1 inches of water column		QM42-DPS1-1Q
	±5 inches of water column		QM42-DPS5-1Q
	±20 inches of water column	QM42-DPS20-1Q	

### All-in-One Current Sensor Nodes

Wireless node uses a current transformer to measure current draw, helping to reveal issues with critical motor performance

Radio Frequency	Measurement Range	Inputs	Models
900 MHz ISM band	0–20 or 0–150 Amps	Amperage (Two current transformers included)	DX80N9Q45CT
2.4 GHz ISM band			DX80N2Q45CT

# More Sensors, More Solutions.

Banner Engineering designs and manufactures industrial automation products including sensors, smart IIoT and industrial wireless technologies, LED lights and indicators, measurement devices, machine safety equipment, as well as barcode scanners and machine vision. These solutions help make many of the things we use every day, from food and medicine to cars and electronics. A high-quality, reliable Banner product is installed somewhere around the world every two seconds. Headquartered in Minneapolis since 1966, Banner is an industry leader with more than 10,000 products, operations on five continents, and a world-wide team of more than 5,500 employees and partners. Our dedication to innovation and personable service makes Banner a trusted source of smart automation technologies to customers around the globe.

