

MAGAPAL®

LE MAGASIN A PALETTES AUTONOME



Le magasin à palettes MAGAPAL® est conçu pour stocker et distribuer les palettes au moyen d'un transpalette ou d'un chariot élévateur. Il met fin aux risques liés aux manutentions manuelles et améliore les conditions de travail ainsi que la productivité.



FICHE TECHNIQUE MAGAPAL®

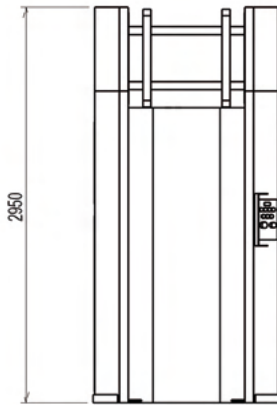
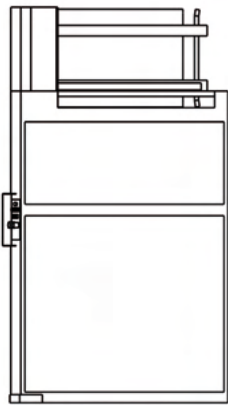

1394 (pal 800x1200)
1594 (pal 1000x1200)
1794 (pal 1200x1200)

Exemple : MAGAPAL®
20 palettes simple pile

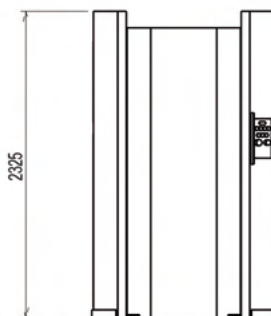
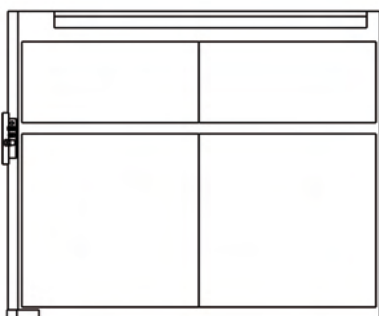
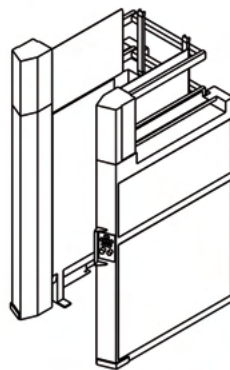
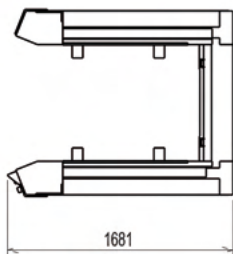

1394 (pal 800x1200)
1594 (pal 1000x1200)

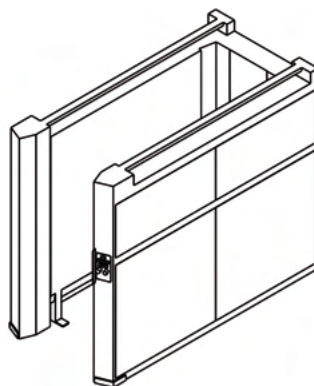
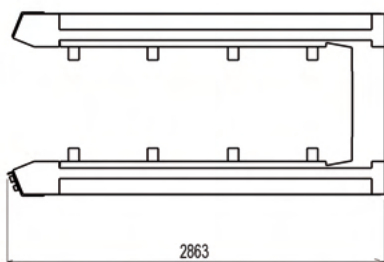

Exemple : MAGAPAL®
15 palettes double pile



- Capacité : de 15 à 30 palettes selon modèle.
- Fonctionnement : automatique ou manuel.
- Energie : hydraulique ou pneumatique.
- 2 versions : simple pile ou double pile de palettes.

TRIAX

Z.A. - 67 rue des Vignes
F-45240 MARCILLY EN VILLETTE

☎ +33 (0)2 38 76 12 00

@ triax@triax-securite.com

🌐 www.triax-securite.com